



PESD2CAN

CAN bus ESD protection diode

Rev. 2 — 27 September 2012

Product data sheet

1. Product profile

1.1 General description

PESD2CAN in a small SOT23 Surface-Mounted Device (SMD) plastic package designed to protect two automotive Controller Area Network (CAN) bus lines from the damage caused by ElectroStatic Discharge (ESD) and other transients.

1.2 Features and benefits

- Max. peak pulse power: $P_{PP} = 230 \text{ W}$ at $t_p = 8/20 \mu\text{s}$
- Low clamping voltage: $V_{CL} = 41 \text{ V}$ at $I_{PP} = 5 \text{ A}$
- Ultra low leakage current: $I_{RM} < 1 \text{ nA}$
- ESD protection up to 30 kV
- IEC 61000-4-2, level 4 (ESD)
- IEC 61000-4-5 (surge); $I_{PP} = 5 \text{ A}$ at $t_p = 8/20 \mu\text{s}$
- AEC-Q101 qualified

1.3 Applications

- CAN bus protection
- Automotive applications

1.4 Quick reference data

Table 1. Quick reference data

Symbol	Parameter	Conditions	Min	Typ	Max	Unit
Per diode						
V_{RWM}	reverse standoff voltage		-	-	24	V
C_d	diode capacitance	$f = 1 \text{ MHz}; V_R = 0 \text{ V}$	-	25	30	pF

2. Pinning information

Table 2. Pinning

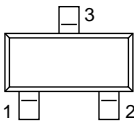
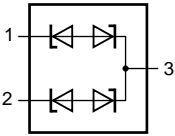
Pin	Description	Simplified outline	Graphic symbol
1	cathode 1		
2	cathode 2		
3	common cathode		

006aaa155

3. Ordering information

Table 3. Ordering information

Type number	Package		Version
	Name	Description	
PESD2CAN	-	plastic surface-mounted package; 3 leads	SOT23

4. Marking

Table 4. Marking codes

Type number	Marking code ^[1]
PESD2CAN	6R*

[1] * = placeholder for manufacturing site code.

5. Limiting values

Table 5. Limiting values

In accordance with the Absolute Maximum Rating System (IEC 60134).

Symbol	Parameter	Conditions	Min	Max	Unit
Per diode					
P_{PP}	peak pulse power	$t_p = 8/20 \mu s$	^{[1][2]} -	230	W
I_{PP}	peak pulse current	$t_p = 8/20 \mu s$	^{[1][2]} -	5	A
Per device					
T_j	junction temperature		-	150	°C
T_{amb}	ambient temperature		-55	+150	°C
T_{stg}	storage temperature		-65	+150	°C

[1] Non-repetitive current pulse 8/20 μs exponential decay waveform according to IEC 61000-4-5.

[2] Measured from pin 1 to 3 or 2 to 3.

Table 6. ESD maximum ratings

Symbol	Parameter	Conditions	Min	Max	Unit
Per diode					
V_{ESD}	electrostatic discharge voltage	IEC 61000-4-2 (contact discharge)	^{[1][2]} -	30	kV
		machine model	^[2] -	400	V
		MIL-STD-883 (human body model)	^{[1][2]} -	16	kV

[1] Device stressed with ten non-repetitive ESD pulses.

[2] Measured from pin 1 to 3 or 2 to 3.

Table 7. ESD standards compliance

Standard	Conditions
Per diode	
IEC 61000-4-2; level 4 (ESD)	> 15 kV (air); > 8 kV (contact)
MIL-STD-883; class 3B (human body model)	> 8 kV

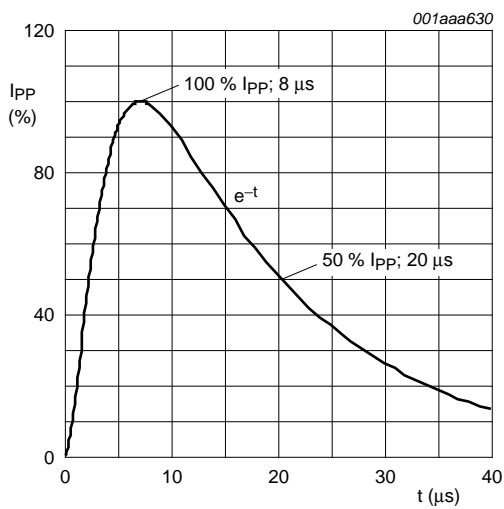

Fig 1. 8/20 μs pulse waveform according to IEC 61000-4-5

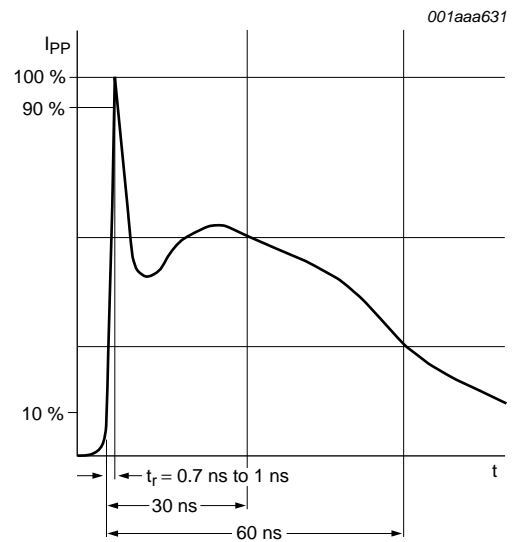

Fig 2. ESD pulse waveform according to IEC 61000-4-2

6. Characteristics

Table 8. Characteristics

$T_{amb} = 25\text{ °C}$ unless otherwise specified.

Symbol	Parameter	Conditions	Min	Typ	Max	Unit
Per diode						
V_{RWM}	reverse standoff voltage		-	-	24	V
I_{RM}	reverse leakage current	$V_{RWM} = 24\text{ V}$	-	< 1	10	nA
V_{BR}	breakdown voltage	$I_R = 1\text{ mA}$	26.2	28	30.3	V
C_d	diode capacitance	$f = 1\text{ MHz}; V_R = 0\text{ V}$	-	25	30	pF
V_{CL}	clamping voltage	$I_{PP} = 1\text{ A}$	[1][2]	-	34	V
		$I_{PP} = 5\text{ A}$	[1][2]	-	41	V
r_{dif}	differential resistance	$I_R = 1\text{ mA}$	-	-	300	Ω

[1] Non-repetitive current pulse 8/20 μs exponential decay waveform according to IEC 61000-4-5.

[2] Measured from pin 1 to 3 or 2 to 3.

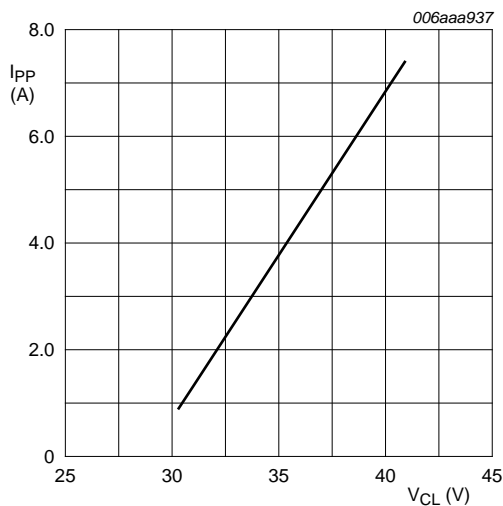

$T_{amb} = 25\text{ °C}$

Fig 3. Peak pulse current as a function of clamping voltage; typical values

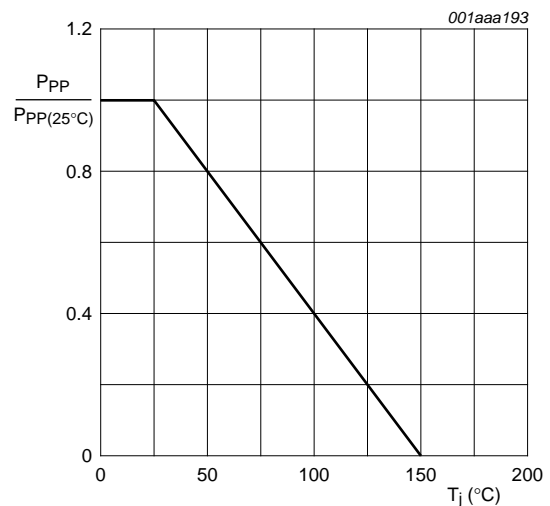
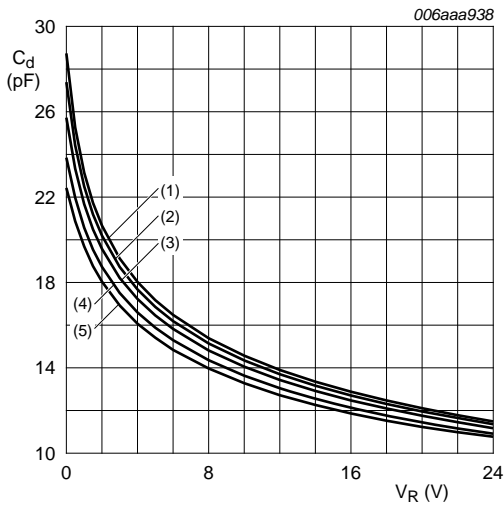
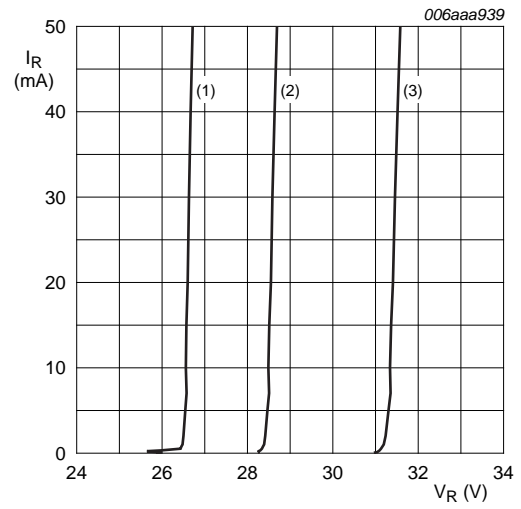

Fig 4. Relative variation of peak pulse power as a function of junction temperature; typical values



- $f = 1 \text{ MHz}$
- (1) $T_{\text{amb}} = 150 \text{ }^\circ\text{C}$
 - (2) $T_{\text{amb}} = 125 \text{ }^\circ\text{C}$
 - (3) $T_{\text{amb}} = 85 \text{ }^\circ\text{C}$
 - (4) $T_{\text{amb}} = 25 \text{ }^\circ\text{C}$
 - (5) $T_{\text{amb}} = -40 \text{ }^\circ\text{C}$

Fig 5. Diode capacitance as a function of reverse voltage; typical values



- (1) $T_{\text{amb}} = -55 \text{ }^\circ\text{C}$
- (2) $T_{\text{amb}} = 25 \text{ }^\circ\text{C}$
- (3) $T_{\text{amb}} = 150 \text{ }^\circ\text{C}$

Fig 6. Reverse current as a function of reverse voltage; typical values

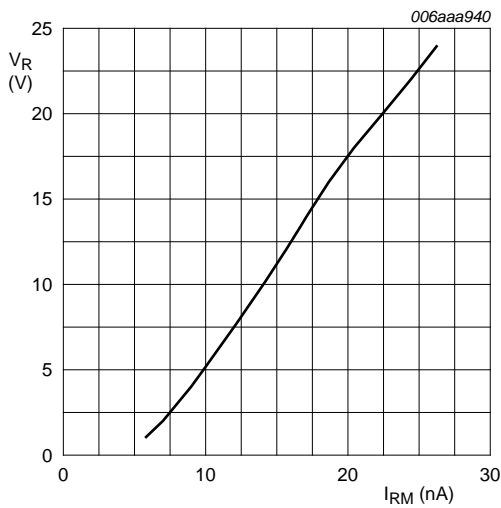

$T_{\text{amb}} = 150 \text{ }^\circ\text{C}$
 I_{R} is less than 1 nA at $-55 \text{ }^\circ\text{C}$ and $25 \text{ }^\circ\text{C}$.

Fig 7. Reverse voltage as a function of reverse leakage current; typical values

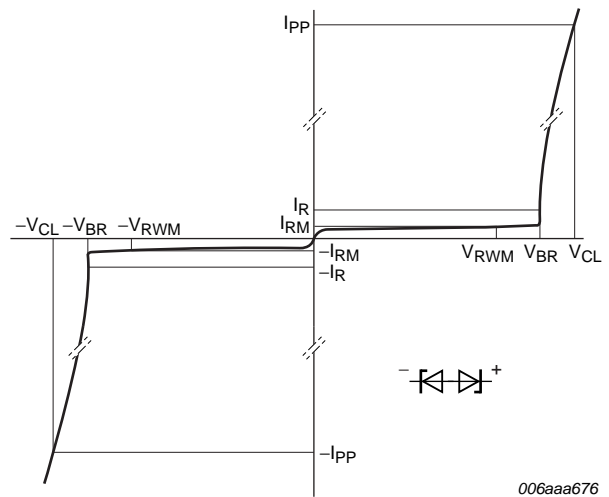

Fig 8. V-I characteristics for a bidirectional ESD protection diode

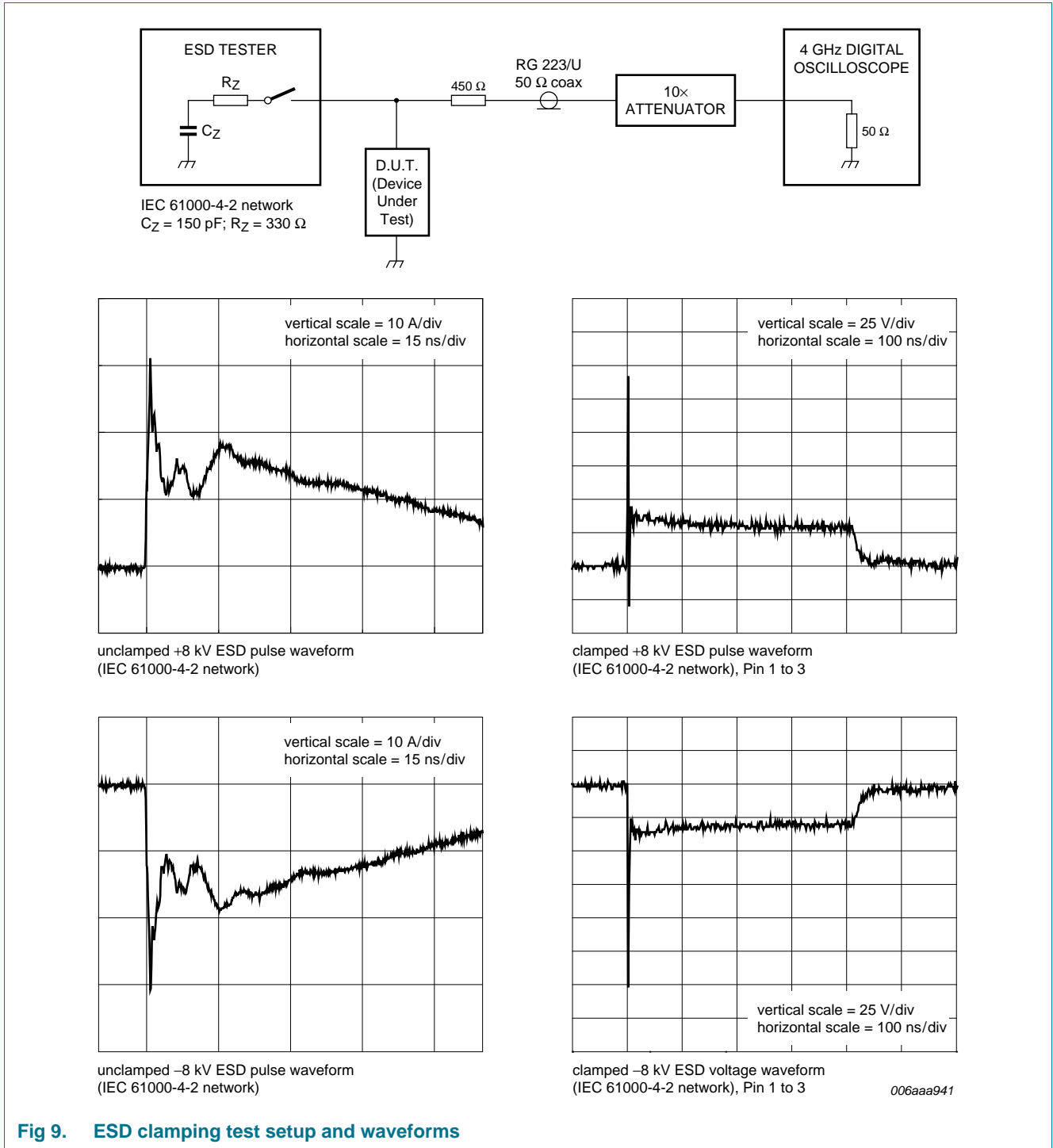

Fig 9. ESD clamping test setup and waveforms

7. Application information

The PESD2CAN is designed for the protection of two automotive CAN bus lines from the damage caused by ESD and surge pulses. The PESD2CAN can be used for both, high-speed CAN bus and fault-tolerant CAN bus protection. The PESD2CAN provides a surge capability of up to 230 W per line for an 8/20 μ s waveform.

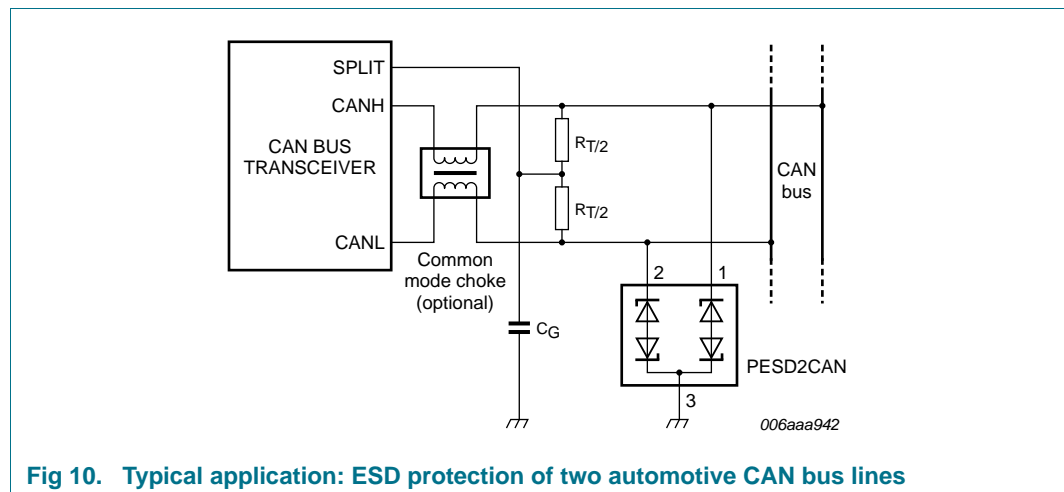

Fig 10. Typical application: ESD protection of two automotive CAN bus lines

Circuit board layout and protection device placement:

Circuit board layout is critical for the suppression of ESD, Electrical Fast Transient (EFT) and surge transients. The following guidelines are recommended:

1. Place the PESD2CAN as close to the input terminal or connector as possible.
2. Minimize the path length between the PESD2CAN and the protected line.
3. Keep parallel signal paths to a minimum.
4. Avoid running protection conductors in parallel with unprotected conductors.
5. Minimize all Printed-Circuit Board (PCB) conductive loops including power and ground loops.
6. Minimize the length of the transient return path to ground.
7. Avoid using shared transient return paths to a common ground point.
8. Use ground planes whenever possible. For multilayer PCBs, use ground vias.

8. Test information

8.1 Quality information

This product has been qualified in accordance with the Automotive Electronics Council (AEC) standard *Q101 - Stress test qualification for discrete semiconductors*, and is suitable for use in automotive applications.

9. Package outline

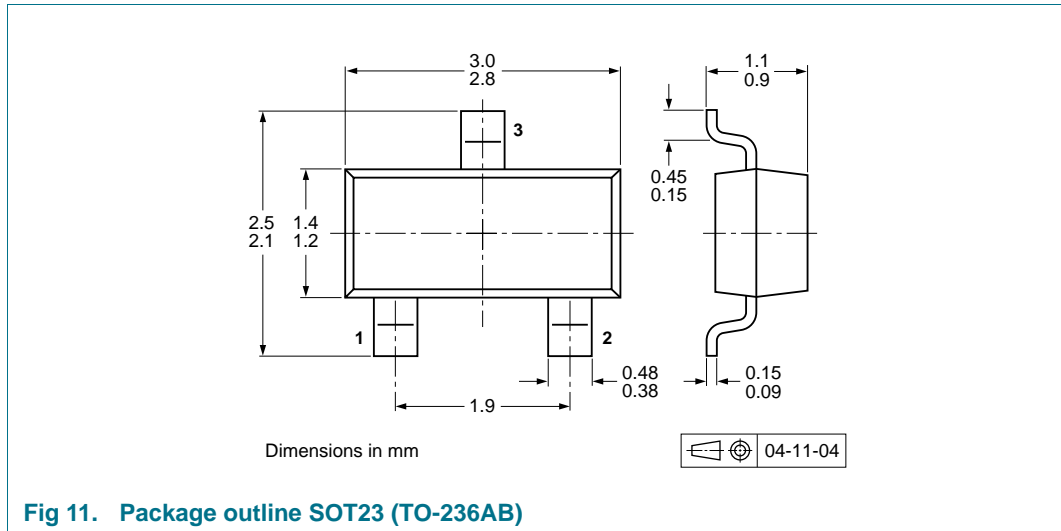

10. Packing information

Table 9. Packing methods

The indicated -xxx are the last three digits of the 12NC ordering code.^[1]

Type number	Package	Description	Packing quantity	
			3000	10000
PESD2CAN	SOT23	4 mm pitch, 8 mm tape and reel	-215	-235

[1] For further information and the availability of packing methods, see [Section 14](#).

11. Soldering

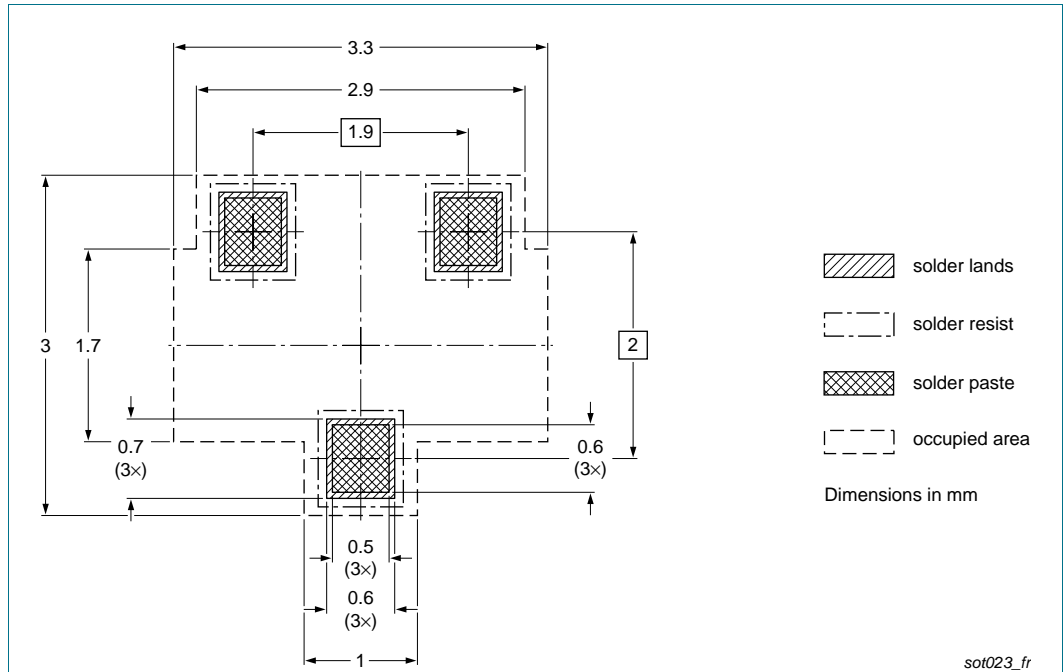

Fig 12. Reflow soldering footprint SOT23 (TO-236AB)

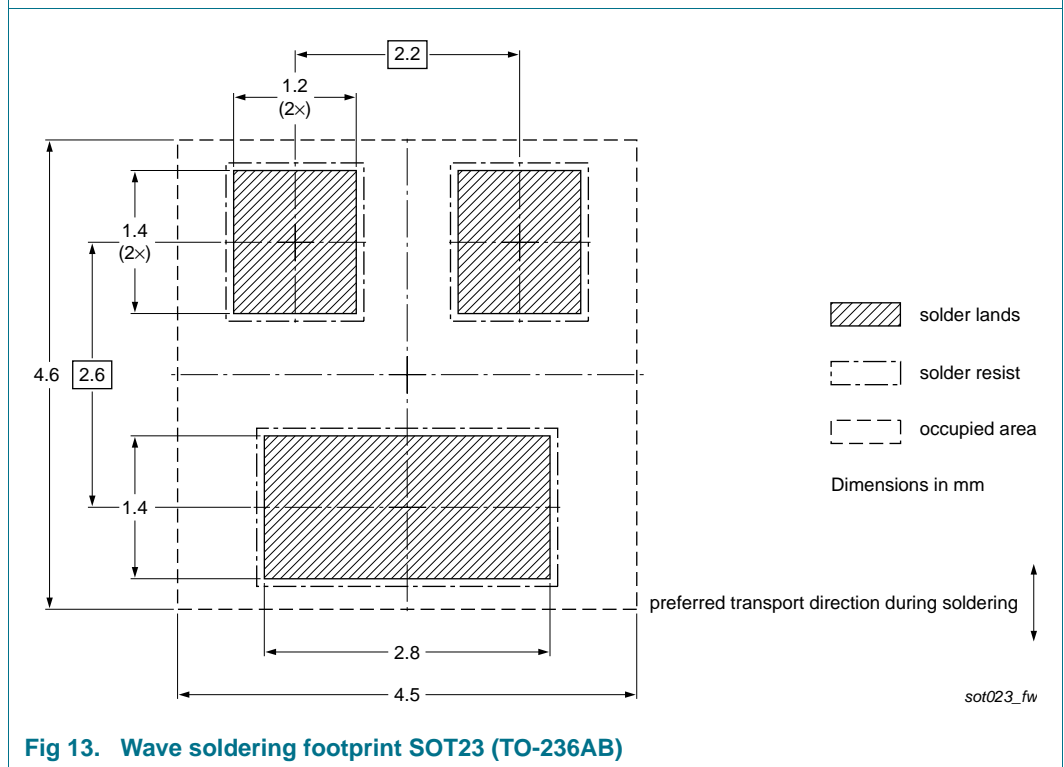

Fig 13. Wave soldering footprint SOT23 (TO-236AB)

12. Revision history

Table 10. Revision history

Document ID	Release date	Data sheet status	Change notice	Supersedes
PESD2CAN v.2	20120927	Product data sheet	-	PESD2CAN v.1
Modifications:	<ul style="list-style-type: none"> • Section 1.2 “Features and benefits”: updated • Table 6 “ESD maximum ratings”: corrected T_{amb} minimum value • Table 7 “ESD standards compliance”: updated • Section 8 “Test information”: added • Section 11 “Soldering”: added • Section 13 “Legal information”: updated 			
PESD2CAN v.1	20061222	Product data sheet	-	-

13. Legal information

13.1 Data sheet status

Document status ^{[1][2]}	Product status ^[3]	Definition
Objective [short] data sheet	Development	This document contains data from the objective specification for product development.
Preliminary [short] data sheet	Qualification	This document contains data from the preliminary specification.
Product [short] data sheet	Production	This document contains the product specification.

[1] Please consult the most recently issued document before initiating or completing a design.

[2] The term 'short data sheet' is explained in section "Definitions".

[3] The product status of device(s) described in this document may have changed since this document was published and may differ in case of multiple devices. The latest product status information is available on the Internet at URL <http://www.nexperia.com>.

13.2 Definitions

Draft — The document is a draft version only. The content is still under internal review and subject to formal approval, which may result in modifications or additions. Nexperia does not give any representations or warranties as to the accuracy or completeness of information included herein and shall have no liability for the consequences of use of such information.

Short data sheet — A short data sheet is an extract from a full data sheet with the same product type number(s) and title. A short data sheet is intended for quick reference only and should not be relied upon to contain detailed and full information. For detailed and full information see the relevant full data sheet, which is available on request via the local Nexperia sales office. In case of any inconsistency or conflict with the short data sheet, the full data sheet shall prevail.

Product specification — The information and data provided in a Product data sheet shall define the specification of the product as agreed between Nexperia and its customer, unless Nexperia and customer have explicitly agreed otherwise in writing. In no event however, shall an agreement be valid in which the Nexperia product is deemed to offer functions and qualities beyond those described in the Product data sheet.

13.3 Disclaimers

Limited warranty and liability — Information in this document is believed to be accurate and reliable. However, Nexperia does not give any representations or warranties, expressed or implied, as to the accuracy or completeness of such information and shall have no liability for the consequences of use of such information. Nexperia takes no responsibility for the content in this document if provided by an information source outside of Nexperia.

In no event shall Nexperia be liable for any indirect, incidental, punitive, special or consequential damages (including - without limitation - lost profits, lost savings, business interruption, costs related to the removal or replacement of any products or rework charges) whether or not such damages are based on tort (including negligence), warranty, breach of contract or any other legal theory.

Notwithstanding any damages that customer might incur for any reason whatsoever, Nexperia's aggregate and cumulative liability towards customer for the products described herein shall be limited in accordance with the *Terms and conditions of commercial sale* of Nexperia.

Right to make changes — Nexperia reserves the right to make changes to information published in this document, including without limitation specifications and product descriptions, at any time and without notice. This document supersedes and replaces all information supplied prior to the publication hereof.

Suitability for use in automotive applications — This Nexperia product has been qualified for use in automotive applications. Unless otherwise agreed in writing, the product is not designed, authorized or warranted to be suitable for use in life support, life-critical or safety-critical systems or equipment, nor in applications where failure or malfunction of a Nexperia product can reasonably be expected to result in personal injury, death or severe property or environmental damage. Nexperia and its suppliers accept no liability for inclusion and/or use of Nexperia products in such equipment or applications and therefore such inclusion and/or use is at the customer's own risk.

Applications — Applications that are described herein for any of these products are for illustrative purposes only. Nexperia makes no representation or warranty that such applications will be suitable for the specified use without further testing or modification.

Customers are responsible for the design and operation of their applications and products using Nexperia products, and Nexperia accepts no liability for any assistance with applications or customer product design. It is customer's sole responsibility to determine whether the Nexperia product is suitable and fit for the customer's applications and products planned, as well as for the planned application and use of customer's third party customer(s). Customers should provide appropriate design and operating safeguards to minimize the risks associated with their applications and products.

Nexperia does not accept any liability related to any default, damage, costs or problem which is based on any weakness or default in the customer's applications or products, or the application or use by customer's third party customer(s). Customer is responsible for doing all necessary testing for the customer's applications and products using Nexperia products in order to avoid a default of the applications and the products or of the application or use by customer's third party customer(s). Nexperia does not accept any liability in this respect.

Limiting values — Stress above one or more limiting values (as defined in the Absolute Maximum Ratings System of IEC 60134) will cause permanent damage to the device. Limiting values are stress ratings only and (proper) operation of the device at these or any other conditions above those given in the Recommended operating conditions section (if present) or the Characteristics sections of this document is not warranted. Constant or repeated exposure to limiting values will permanently and irreversibly affect the quality and reliability of the device.

Terms and conditions of commercial sale — Nexperia products are sold subject to the general terms and conditions of commercial sale, as published at <http://www.nexperia.com/profile/terms>, unless otherwise agreed in a valid written individual agreement. In case an individual agreement is concluded only the terms and conditions of the respective agreement shall apply. Nexperia hereby expressly objects to applying the customer's general terms and conditions with regard to the purchase of Nexperia products by customer.

No offer to sell or license — Nothing in this document may be interpreted or construed as an offer to sell products that is open for acceptance or the grant, conveyance or implication of any license under any copyrights, patents or other industrial or intellectual property rights.

Export control — This document as well as the item(s) described herein may be subject to export control regulations. Export might require a prior authorization from competent authorities.

Quick reference data — The Quick reference data is an extract of the product data given in the Limiting values and Characteristics sections of this document, and as such is not complete, exhaustive or legally binding.

13.4 Trademarks

Notice: All referenced brands, product names, service names and trademarks are the property of their respective owners.

14. Contact information

For more information, please visit: <http://www.nexperia.com>

For sales office addresses, please send an email to: salesaddresses@nexperia.com

15. Contents

1	Product profile	1
1.1	General description	1
1.2	Features and benefits	1
1.3	Applications	1
1.4	Quick reference data	1
2	Pinning information	1
3	Ordering information	2
4	Marking	2
5	Limiting values	2
6	Characteristics	4
7	Application information	7
8	Test information	7
8.1	Quality information	7
9	Package outline	8
10	Packing information	8
11	Soldering	9
12	Revision history	10
13	Legal information	11
13.1	Data sheet status	11
13.2	Definitions	11
13.3	Disclaimers	11
13.4	Trademarks	12
14	Contact information	12
15	Contents	13