

### DESCRIPTION

The MP2148 is a monolithic, step-down, switch-mode converter with built-in internal power MOSFETs. It achieves 1A continuous output current from a 2.3V-to-5.5V input voltage with excellent load and line regulation. The output voltage can be regulated to as low as 0.6V.

The Constant-On-Time control scheme provides fast transient response and eases loop stabilization. Fault protections include cycle-by-cycle current limiting and thermal shutdown.

The MP2148 is available in an ultra-small QFN-6 (1.0mmx1.5mm) package and requires a minimal number of readily available standard external components.

The MP2148 is ideal for a wide range of applications including high performance DSPs, wireless power, portable and mobile devices, and other low-power systems.

### FEATURES

- Low I<sub>Q</sub>: 11µA
- 2.2MHz Switching Frequency
- EN for Power Sequencing
- Power Good Only for Fixed Output Version
- Wide 2.3V-to-5.5V Operating Input Range
- Output Adjustable from 0.6V
- Up to 1A Output Current
- 120mΩ and 80mΩ Internal Power MOSFET Switches
- Output Discharge
- 100% Duty Cycle
- Short-Circuit Protection with Hiccup Mode
- Stable with Low ESR Output Ceramic Capacitors
- Available in a QFN-6 (1.0mmx1.5mm) Package

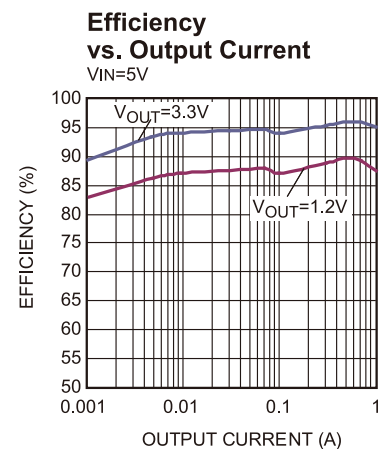
### APPLICATIONS

- Wireless/Networking Cards
- Portable and Mobile Devices
- Battery Powered /Wearable Devices
- Low Voltage I/O System Power

All MPS parts are lead-free, halogen free, and adhere to the RoHS directive. For MPS green status, please visit MPS website under Quality Assurance.

“MPS” and “The Future of Analog IC Technology” are Registered Trademarks of Monolithic Power Systems, Inc.

### TYPICAL APPLICATION



## ORDERING INFORMATION

| Part Number* | Package             | Top Marking | V <sub>OUT</sub> Range |
|--------------|---------------------|-------------|------------------------|
| MP2148GQD    | QFN-6 (1.0mmx1.5mm) | See Below   | Adjustable             |
| MP2148GQD-12 |                     | See Below   | Fixed 1.2V             |
| MP2148GQD-15 |                     | See Below   | Fixed 1.5V             |
| MP2148GQD-18 |                     | See Below   | Fixed 1.8V             |
| MP2148GQD-25 |                     | See Below   | Fixed 2.5V             |
| MP2148GQD-33 |                     | See Below   | Fixed 3.3V             |

\* For Tape & Reel, add suffix –Z (e.g. MP2148GQD–Z);

### TOP MARKING

—  
CF  
LL

CF: product code of MP2148GQD;  
LL: lot number;

### TOP MARKING

—  
DH  
LL

DH: product code of MP2148GQD-12;  
LL: lot number;

### TOP MARKING

—  
DQ  
LL

DQ: product code of MP2148GQD-15;  
LL: lot number;

**TOP MARKING**

—  
DJ  
LL

DJ: product code of MP2148GQD-18;  
LL: lot number;

**TOP MARKING**

—  
DZ  
LL

DZ: product code of MP2148GQD-25;  
LL: lot number;

**TOP MARKING**

—  
DN  
LL

DN: product code of MP2148GQD-33;  
LL: lot number;

### PACKAGE REFERENCE

| TOP VIEW            |   |   | TOP VIEW                                                               |     |   |   |     |
|---------------------|---|---|------------------------------------------------------------------------|-----|---|---|-----|
| FB                  | 1 | 6 | OUT                                                                    | PG  | 1 | 6 | OUT |
| GND                 | 2 | 5 | EN                                                                     | GND | 2 | 5 | EN  |
| VIN                 | 3 | 4 | SW                                                                     | VIN | 3 | 4 | SW  |
| MP2148GQD           |   |   | MP2148GQD-12 MP2148GQD-15<br>MP2148GQD-18 MP2148GQD-25<br>MP2148GQD-33 |     |   |   |     |
| QFN-6 (1.0mmx1.5mm) |   |   |                                                                        |     |   |   |     |

#### ABSOLUTE MAXIMUM RATINGS <sup>(1)</sup>

|                                                                               |                                                               |
|-------------------------------------------------------------------------------|---------------------------------------------------------------|
| Supply Voltage V <sub>IN</sub> .....                                          | 6 V                                                           |
| V <sub>SW</sub> .....                                                         | -0.3V (-5V for <10ns) to<br>6V (8V for <10ns or 10V for <3ns) |
| All Other Pins.....                                                           | -0.3V to 6V                                                   |
| Junction Temperature.....                                                     | 150°C                                                         |
| Lead Temperature .....                                                        | 260°C                                                         |
| Continuous Power Dissipation (T <sub>A</sub> = +25°C) <sup>(2)</sup><br>..... | 0.6W                                                          |
| Storage Temperature.....                                                      | -65°C to +150°C                                               |

#### Recommended Operating Conditions <sup>(3)</sup>

|                                                             |              |
|-------------------------------------------------------------|--------------|
| Supply Voltage V <sub>IN</sub> .....                        | 2.3V to 5.5V |
| Operating Junction Temp. (T <sub>J</sub> ). -40°C to +125°C |              |

|                                          |                       |                       |
|------------------------------------------|-----------------------|-----------------------|
| <b>Thermal Resistance <sup>(4)</sup></b> | <b>θ<sub>JA</sub></b> | <b>θ<sub>JC</sub></b> |
| QFN-6 (1mm x1.5mm).....                  | 220                   | 110 °C/W              |

#### Notes:

- Exceeding these ratings may damage the device.
- The maximum allowable power dissipation is a function of the maximum junction temperature T<sub>J</sub> (MAX), the junction-to-ambient thermal resistance θ<sub>JA</sub>, and the ambient temperature T<sub>A</sub>. The maximum allowable continuous power dissipation at any ambient temperature is calculated by P<sub>D</sub> (MAX) = (T<sub>J</sub> (MAX)-T<sub>A</sub>)/θ<sub>JA</sub>. Exceeding the maximum allowable power dissipation will cause excessive die temperature, and the regulator will go into thermal shutdown. Internal thermal shutdown circuitry protects the device from permanent damage.
- The device is not guaranteed to function outside of its operating conditions.
- Measured on JESD51-7, 4-layer PCB.

## ELECTRICAL CHARACTERISTICS

V<sub>IN</sub> = 3.6V, T<sub>J</sub> = -40°C to +125°C, Typical value is tested at T<sub>J</sub> = +25°C. The limit over temperature is guaranteed by characterization, unless otherwise noted.

| Parameter                            | Symbol                | Condition                                                                      | Min   | Typ | Max   | Units |
|--------------------------------------|-----------------------|--------------------------------------------------------------------------------|-------|-----|-------|-------|
| Feedback Voltage<br>(MP2148GQD Only) | V <sub>FB</sub>       | 2.3V ≤ V <sub>IN</sub> ≤ 5.5V, T <sub>J</sub> =25°C                            | 594   | 600 | 606   | mV    |
|                                      |                       | T <sub>J</sub> =-40°C to +125°C                                                | 588   |     | 612   |       |
| Fixed Output Voltage <sup>(7)</sup>  |                       | Only for MP2148GQD-12, I <sub>OUT</sub> =10mA, T <sub>J</sub> =+25°C           | 1.188 | 1.2 | 1.212 | V     |
|                                      |                       | Only for MP2148GQD-12, I <sub>OUT</sub> =10mA, T <sub>J</sub> =-40°C to +125°C | 1.176 | 1.2 | 1.224 | V     |
|                                      |                       | Only for MP2148GQD-15, I <sub>OUT</sub> =10mA, T <sub>J</sub> =+25°C           | 1.485 | 1.5 | 1.515 | V     |
|                                      |                       | Only for MP2148GQD-15, I <sub>OUT</sub> =10mA, T <sub>J</sub> =-40°C to +125°C | 1.470 | 1.5 | 1.530 | V     |
|                                      |                       | Only for MP2148GQD-18, I <sub>OUT</sub> =10mA, T <sub>J</sub> =+25°C           | 1.782 | 1.8 | 1.818 | V     |
|                                      |                       | Only for MP2148GQD-18, I <sub>OUT</sub> =10mA, T <sub>J</sub> =-40°C to +125°C | 1.764 | 1.8 | 1.836 | V     |
|                                      |                       | Only for MP2148GQD-25, I <sub>OUT</sub> =10mA, T <sub>J</sub> =+25°C           | 2.475 | 2.5 | 2.525 | V     |
|                                      |                       | Only for MP2148GQD-25, I <sub>OUT</sub> =10mA, T <sub>J</sub> =-40°C to +125°C | 2.450 | 2.5 | 2.550 | V     |
|                                      |                       | Only for MP2148GQD-33, I <sub>OUT</sub> =10mA, T <sub>J</sub> =+25°C           | 3.267 | 3.3 | 3.333 | V     |
|                                      |                       | Only for MP2148GQD-33, I <sub>OUT</sub> =10mA, T <sub>J</sub> =-40°C to +125°C | 3.234 | 3.3 | 3.366 | V     |
| Feedback Current<br>(MP2148GQD only) | I <sub>FB</sub>       | V <sub>FB</sub> = 0.63V                                                        |       | 50  | 100   | nA    |
| PFET Switch On Resistance            | R <sub>DS(on) P</sub> |                                                                                |       | 120 |       | mΩ    |
| NFET Switch On Resistance            | R <sub>DS(on) N</sub> |                                                                                |       | 80  |       | mΩ    |
| Switch Leakage Current               |                       | V <sub>EN</sub> = 0V, T <sub>J</sub> =25°C                                     |       | 0   | 1     | µA    |
| PFET Peak Current Limit              |                       | Sourcing                                                                       | 1.8   | 2.4 |       | A     |
| NFET Valley Current Limit            |                       | Sourcing, valley current limit                                                 |       | 1.5 |       | A     |
| ZCD                                  |                       |                                                                                |       | 0   |       | mA    |
| On Time<br>(MP2148GQD only)          | T <sub>ON</sub>       | V <sub>IN</sub> =5V, V <sub>OUT</sub> =1.2V                                    |       | 110 |       | ns    |
|                                      |                       | V <sub>IN</sub> =3.6V, V <sub>OUT</sub> =1.2V                                  |       | 150 |       |       |

## ELECTRICAL CHARACTERISTICS

V<sub>IN</sub> = 3.6V, T<sub>J</sub> = -40°C to +125°C, Typical value is tested at T<sub>J</sub> = +25°C. The limit over temperature is guaranteed by characterization, unless otherwise noted.

| Parameter                                                    | Symbol               | Condition                                                                                                                  | Min  | Typ  | Max  | Units |
|--------------------------------------------------------------|----------------------|----------------------------------------------------------------------------------------------------------------------------|------|------|------|-------|
| Switching Frequency                                          | f <sub>s</sub>       | V <sub>IN</sub> =5V, V <sub>OUT</sub> =1.2V,<br>I <sub>OUT</sub> =500mA, T <sub>J</sub> =25°C <sup>(5)</sup>               | 1760 | 2200 | 2640 | kHz   |
|                                                              |                      | V <sub>IN</sub> =5V, V <sub>OUT</sub> =1.2V,<br>I <sub>OUT</sub> =500mA, T <sub>J</sub> =-40°C to<br>+125°C <sup>(5)</sup> | 1650 | 2200 | 2750 | kHz   |
| Minimum Off Time                                             | T <sub>MIN-OFF</sub> |                                                                                                                            |      | 60   |      | ns    |
| Minimum On Time <sup>(5)</sup>                               | T <sub>MIN-ON</sub>  |                                                                                                                            |      | 60   |      | ns    |
| Soft-Start Time                                              | T <sub>SS-ON</sub>   | V <sub>OUT</sub> rise from 10% to 90%                                                                                      |      | 0.5  |      | ms    |
| Under Voltage Lockout<br>Threshold Rising                    |                      |                                                                                                                            |      | 2    | 2.25 | V     |
| Under Voltage Lockout<br>Threshold Hysteresis                |                      |                                                                                                                            |      | 150  |      | mV    |
| EN Input Logic Low Voltage                                   |                      |                                                                                                                            |      |      | 0.4  | V     |
| EN Input Logic High Voltage                                  |                      |                                                                                                                            | 1.2  |      |      | V     |
| Output Discharge Resistor                                    | R <sub>DIS</sub>     | V <sub>EN</sub> =0V, V <sub>OUT</sub> =1.2V                                                                                |      | 1    |      | kΩ    |
| EN Input Current                                             |                      | V <sub>EN</sub> =2V                                                                                                        |      | 1.2  |      | µA    |
|                                                              |                      | V <sub>EN</sub> =0V                                                                                                        |      | 0    |      | µA    |
| Supply Current (Shutdown)                                    |                      | V <sub>EN</sub> =0V, T <sub>J</sub> =25°C                                                                                  |      | 0    | 1    | µA    |
| Supply Current (Quiescent)                                   |                      | V <sub>EN</sub> =2V, V <sub>FB</sub> =0.63V,<br>V <sub>IN</sub> =3.6V,5V, T <sub>J</sub> =25°C                             |      | 11   | 13   | µA    |
| Power Good Leakage<br>Current<br>(MP2148GQD-XX only)         | I <sub>PG</sub>      |                                                                                                                            |      | 50   | 100  | nA    |
| Power Good Upper Trip<br>Threshold<br>(MP2148GQD-XX only)    |                      | Vo with Respect to the<br>Regulation                                                                                       |      | 90   |      | %     |
| Power Good Lower Trip<br>Threshold<br>(MP2148GQD-XX only)    |                      |                                                                                                                            |      | 85   |      | %     |
| Power Good Delay<br>(MP2148GQD-XX only)                      |                      |                                                                                                                            |      | 70   |      | µs    |
| Power Good Sink Current<br>Capability<br>(MP2148GQD-XX only) |                      | Sink 1mA                                                                                                                   |      |      | 400  | mV    |
| Thermal Shutdown <sup>(6)</sup>                              |                      |                                                                                                                            |      | 160  |      | °C    |
| Thermal Hysteresis <sup>(6)</sup>                            |                      |                                                                                                                            |      | 30   |      | °C    |

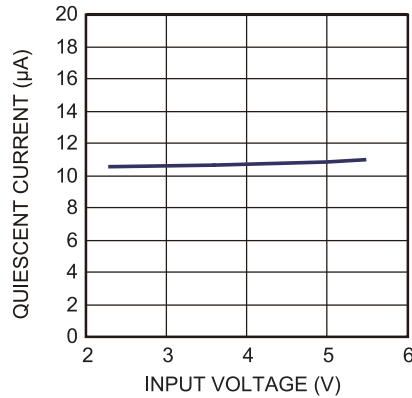
### Notes:

- 5) Guaranteed by characterization.
- 6) Guaranteed by design.
- 7) Without Sleep Mode.

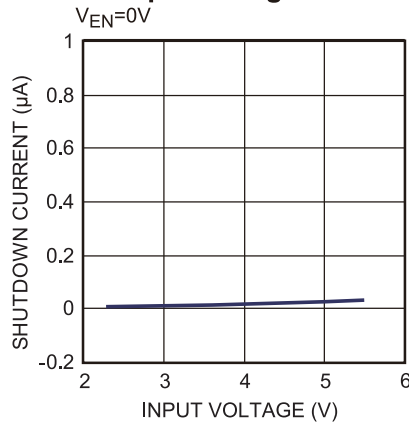
## TYPICAL PERFORMANCE CHARACTERISTICS

$V_{IN} = 5V$ ,  $V_{OUT} = 1.2V$ ,  $L = 1.0\mu H$ ,  $T_A = +25^\circ C$ , unless otherwise noted.

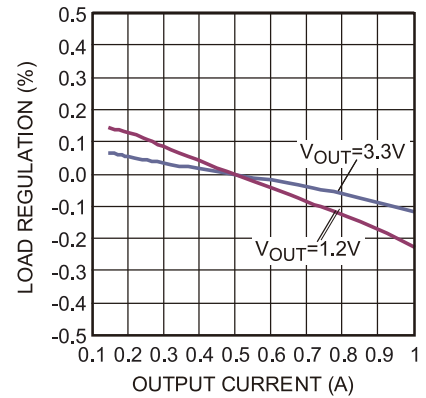
**Quiescent Current vs. Input Voltage**



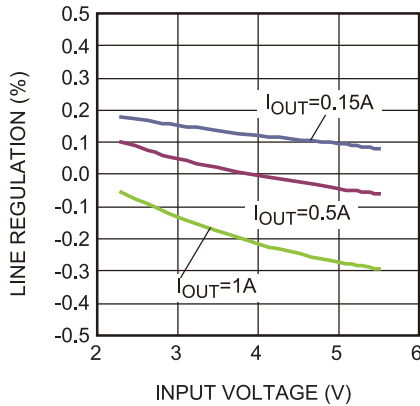
**Shutdown Current vs. Input Voltage**



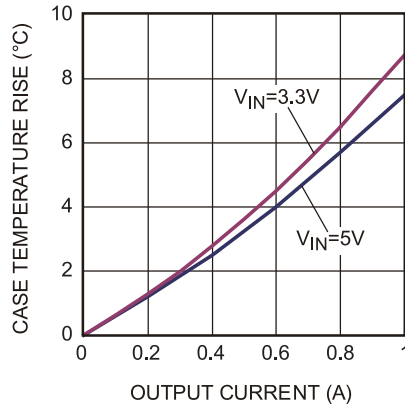
**Load Regulation vs. Output Current**



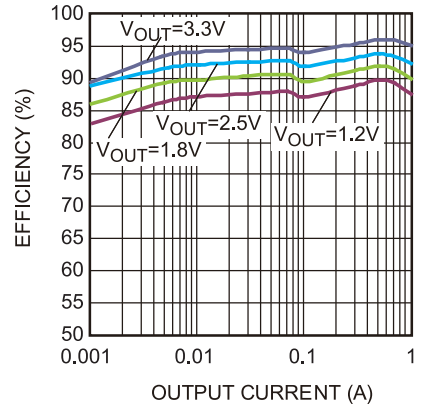
**Line Regulation vs. Input Voltage**



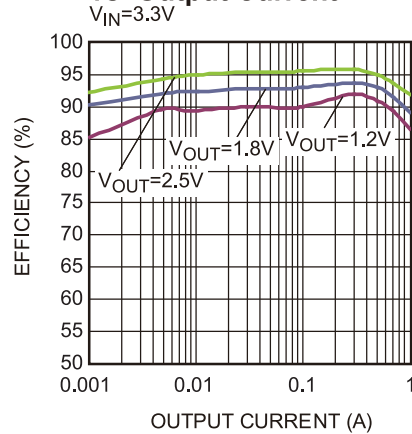
**Case Temperature Rise**



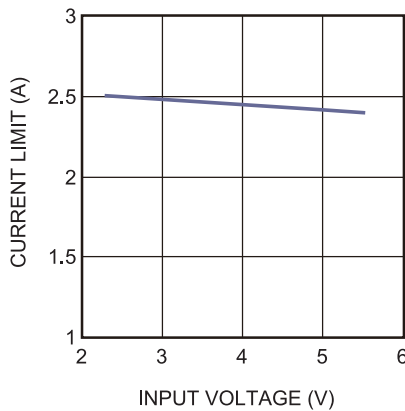
**Efficiency vs. Output Current**



**Efficiency vs. Output Current**



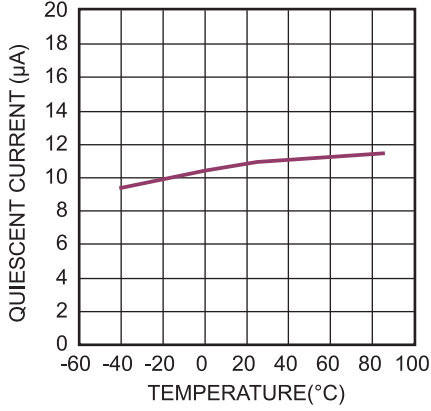
**Current Limit vs.  $V_{IN}$**



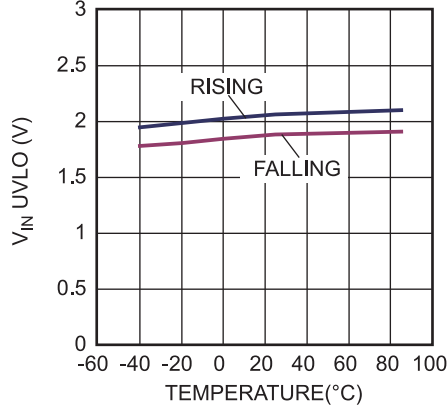
## TYPICAL PERFORMANCE CHARACTERISTICS (continued)

V<sub>IN</sub> = 5V, V<sub>OUT</sub> = 1.2V, L = 1.0µH, T<sub>A</sub> = +25°C, unless otherwise noted.

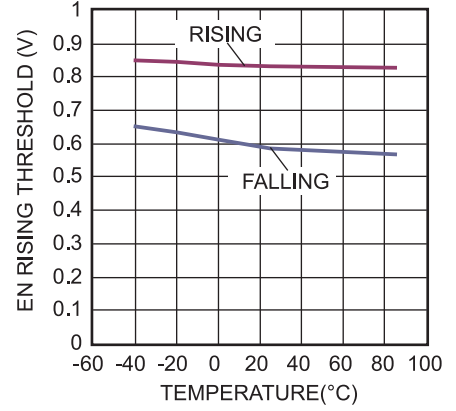
**Quiescent Current vs. Temperature**



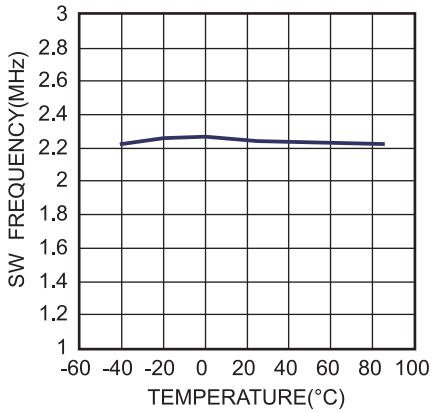
**V<sub>IN</sub> UVLO Rising and Falling Threshold vs. Temperature**



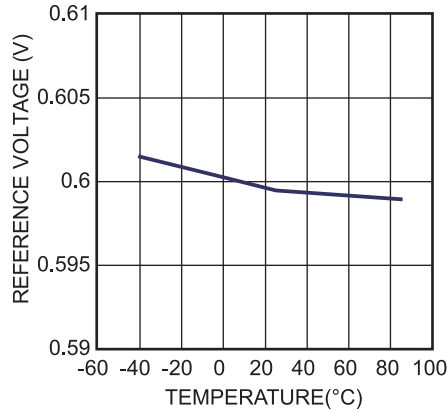
**EN Rising and Falling Threshold vs. Temperature**



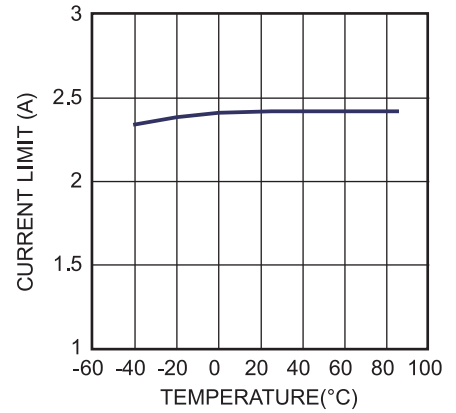
**Switch Frequency vs. Temperature**



**Reference Voltage vs. Temperature**  
V<sub>IN</sub>=3.6V



**Current Limit vs. Temperature**





## TYPICAL PERFORMANCE CHARACTERISTICS (continued)

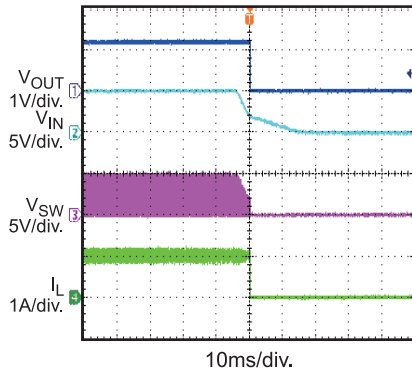
$V_{IN} = 5V$ ,  $V_{OUT} = 1.2V$ ,  $L = 1.0\mu H$ ,  $T_A = +25^\circ C$ , unless otherwise noted.



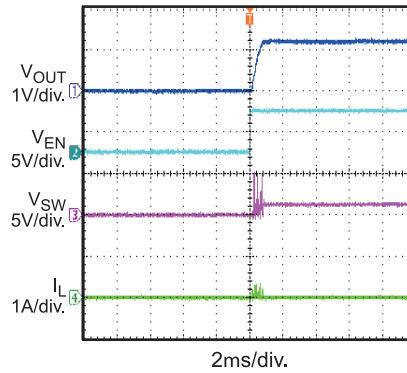
## TYPICAL PERFORMANCE CHARACTERISTICS (continued)

V<sub>IN</sub> = 5V, V<sub>OUT</sub> = 1.2V, L = 1.0 $\mu$ H, T<sub>A</sub> = +25 $^{\circ}$ C, unless otherwise noted.

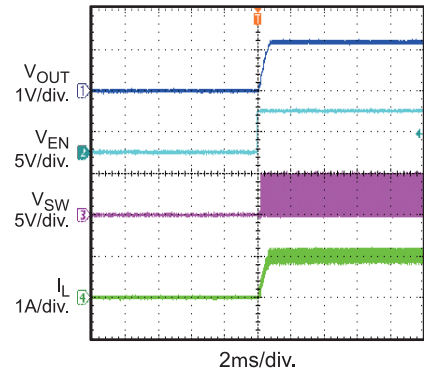
**V<sub>IN</sub> Shut Down**  
with 1A Load



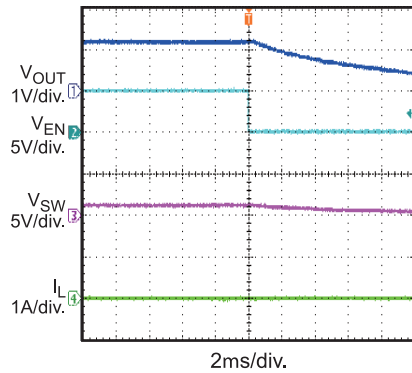
**EN Start Up**  
without Load



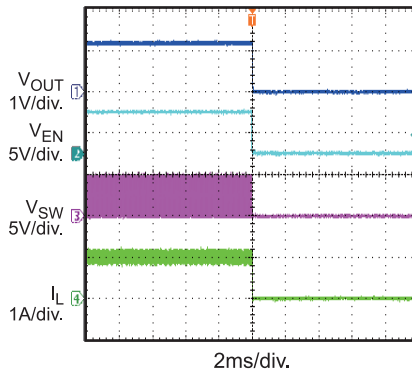
**EN Start Up**  
with 1A Load



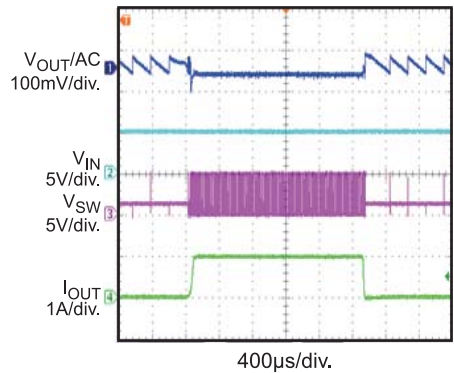
**EN Shut Down**  
without Load



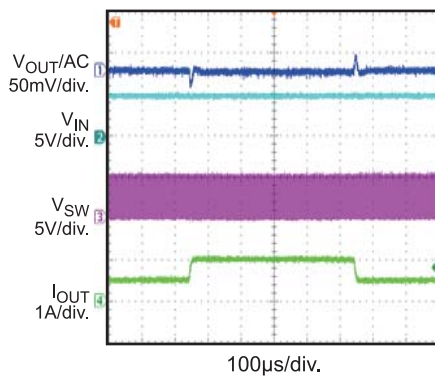
**EN Shut Down**  
with 1A Load



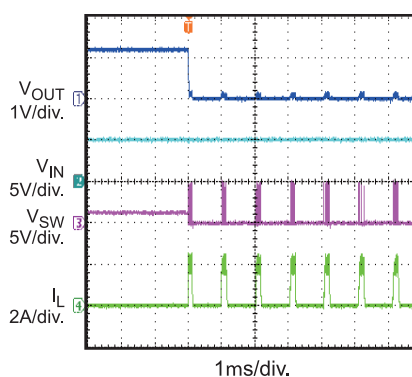
**Load Transient Response**  
I<sub>OUT</sub> = 0A to 1A



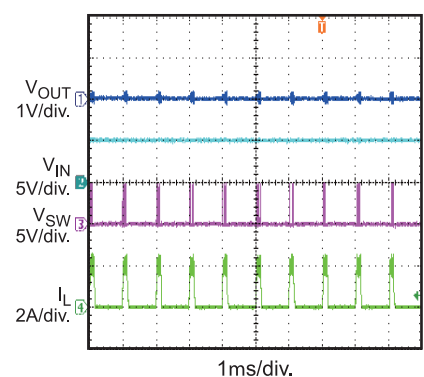
**Load Transient Response**  
I<sub>OUT</sub> = 0.5A to 1A



**Short Circuit Entry**



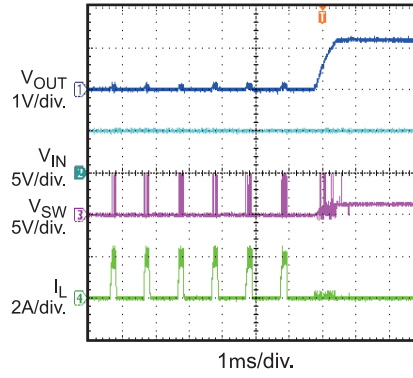
**Short Circuit**



## TYPICAL PERFORMANCE CHARACTERISTICS *(continued)*

V<sub>IN</sub> = 5V, V<sub>OUT</sub> = 1.2V, L = 1.0 $\mu$ H, T<sub>A</sub> = +25°C, unless otherwise noted.

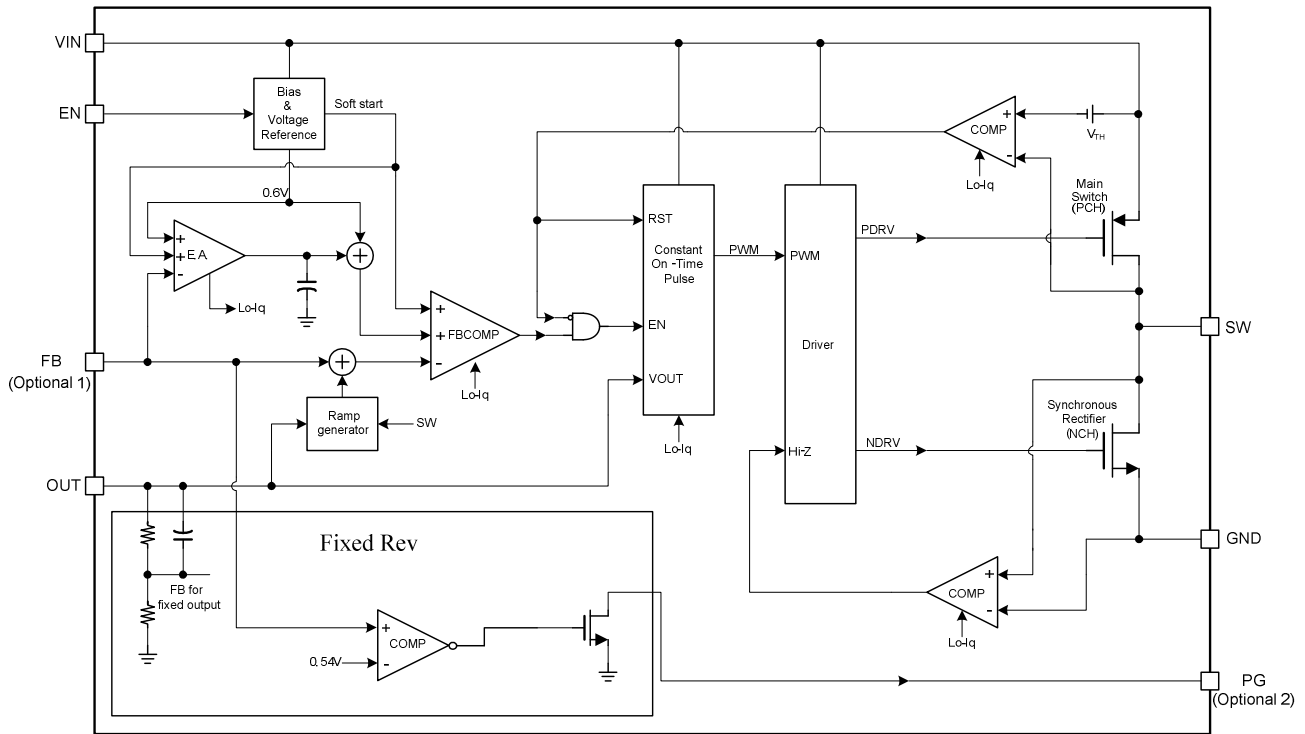
### Short Circuit Recovery



## PIN FUNCTIONS

| Pin # | Name  | Description                                                                                                                                                                                                                                                                  |
|-------|-------|------------------------------------------------------------------------------------------------------------------------------------------------------------------------------------------------------------------------------------------------------------------------------|
| 1     | FB/PG | MP2148GQD: Feedback Pin. An external resistor divider from the output to GND, tapped to the FB pin, sets the output voltage.<br>MP2148GQD-XX: Power Good Indicator. The output of this pin is an open drain output. Keep PG pulls up voltage is lower than V <sub>in</sub> . |
| 2     | GND   | Power Ground.                                                                                                                                                                                                                                                                |
| 3     | VIN   | Supply Voltage. The MP2148 operates from a +2.3V to +5.5V unregulated input. Decouple capacitor is needed to prevent large voltage spikes from appearing at the input.                                                                                                       |
| 4     | SW    | Output Switching Node. SW is the drain of the internal high-side P-Channel MOSFET. Connect the inductor to SW to complete the converter.                                                                                                                                     |
| 5     | EN    | On/Off Control.                                                                                                                                                                                                                                                              |
| 6     | OUT   | Output Voltage Power Rail and Input Sense Pin for Output Voltage. Connect load to this pin. Output capacitor is needed to decrease the output voltage ripple.                                                                                                                |

## BLOCK DIAGRAM



**Figure 1: Functional Block Diagram**

**Note: Optional 1: FB pin is only for MP2148GQD**

**Optional 2: PG pin is only for MP2148GQD-XX**

## OPERATION

The MP2148 uses constant on-time control with input voltage feed forward to stabilize the switching frequency over the full input range. It achieves 1A continuous output current from a 2.3V-to-5.5V input voltage with excellent load and line regulation. The output voltage can be regulated to as low as 0.6V.

### Constant On-Time Control

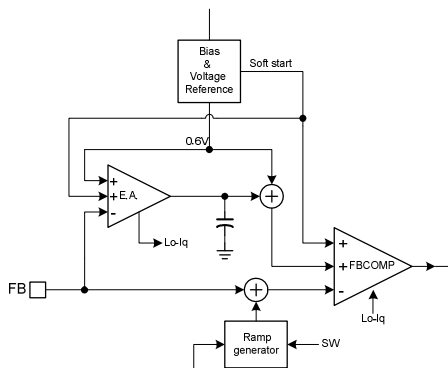
Compare to fixed frequency PWM control, constant on-time control offers a simpler control loop and a faster transient response. By using input-voltage feed forward, the MP2148 maintains a nearly constant switching frequency across the input and output voltage ranges. The switching pulse on time can be estimated as:

$$T_{ON} = \frac{V_{OUT}}{V_{IN}} \cdot 0.454\mu s$$

To prevent inductor current runaway during load transient, MP2148 has fixed minimum off time of 60ns.

### Sleep Mode Operation

MP2148 features sleep mode to get high efficiency at extreme light load. In sleep-mode, most of the circuit blocks are turned off, except the error amplifier and PWM comparator, thus the operation current is reduced to a minimal value, as Figure 2.



**Figure 2: Operation Blocks at Sleep Mode**

When the loading gets lighter, the ripple of the output voltage is bigger and it drives the error amplifier output (EAO) lower. When EAO hits an internal low threshold, it will be clamped at that level, MP2148 enters sleep mode. During sleep mode, the valley of the FB pin voltage is

regulated to the internal reference voltage, thus, the average output voltage is slightly higher than the output voltage at DCM or CCM mode. The on-time pulse at sleep mode is around 40% larger than that on DCM or CCM mode. Figure 3 shows the average FB pin voltage relationship with the internal reference at sleep mode.



**Figure 3: FB Average Voltage at Sleep Mode**

When MP2148 is in sleep mode, the average output voltage is higher than the internal reference voltage. The EAO is kept low and clamped in sleep mode. When the loading increases, the PWM switching period decreases in order to keep the output voltage regulated and the output voltage ripple is decrease relatively. Once EAO is more than internal low threshold, MP2148 will be out of sleep mode and enter DCM or CCM mode depending on the loading. In DCM or CCM mode, the EA regulates the average output voltage to the internal reference which is shown in Figure 4.



**Figure 4: DCM Mode Control**

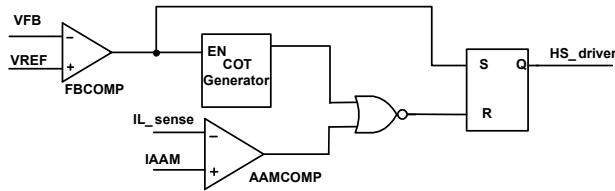
There is always a loading hysteresis of entering sleep mode and leaving sleep mode due to the error amplifier clamping response time.

### AAM Operation at Light-Load Operation

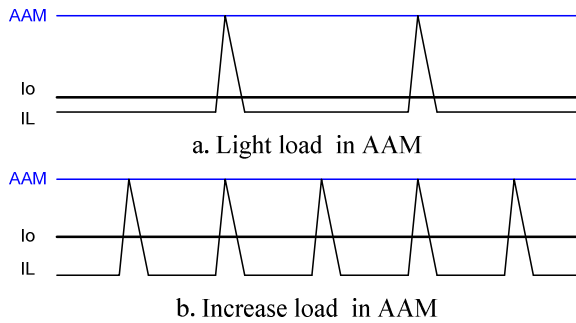
The MP2148 has AAM (Advanced Asynchronous Modulation) power-save mode together with ZCD (Zero Current Cross Detection) circuit for light load.

The MP2148 has AAM power-save mode for light load. Simplified AAM control theory is as Figure 5. AAM current I<sub>AAM</sub> is set internally. The SW on pulse time is decided by on-timer generator and AAM comparator. At light load condition, the SW on pulse time is the longer one. If the AAM comparator pulse is longer than

on-timer generator, the operation mode is below in Figure 6.

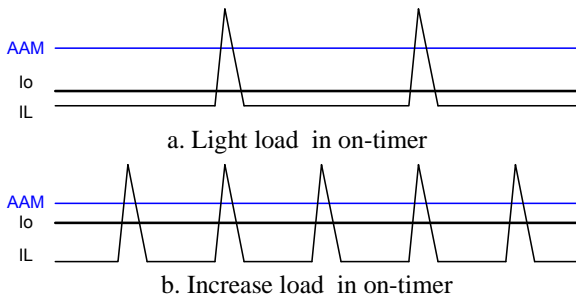


**Figure 5: Simplified AAM Control Logic**



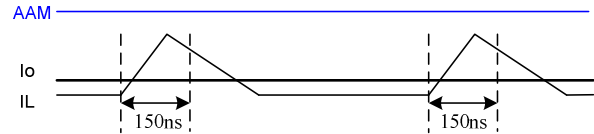
**Figure 6: AAM Comparator Control Ton**

If the AAM comparator pulse is shorter than on-timer generator, the operation mode is below in Figure 7. Generally, using very small inductance may bring this case.



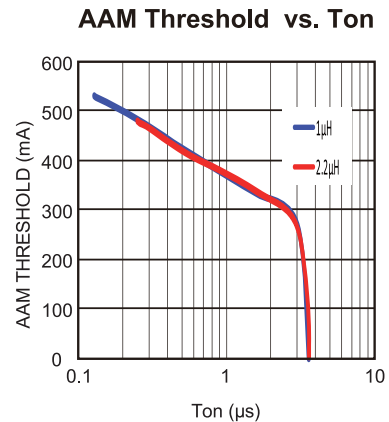
**Figure 7: On-Timer Control Ton**

Except upper on-timer method, AAM circuit has another 150ns AAM blank time in sleep mode. That means if on-timer is less than 150ns, the high side MOSFET may turn off after on-timer generator pulse without AAM control. Just a remind, the on-time pulse at sleep mode is around 40% larger than that on DCM or CCM mode. At this condition,  $I_L$  may not reach AAM threshold as Figure 8.



**Figure 8: AAM Blank Time in Sleep Mode**

Figure9 shows AAM threshold decreases with  $T_{on}$  increasing gradually. For the CCM state,  $I_o$  needs more than half of AAM threshold at least.



**Figure 9: AAM Threshold decreases with  $T_{on}$  Increases.**

MP2148 have a zero current cross detect circuit (ZCD) to judge if the inductor current starts to reverse. When the inductor current reaches ZCD threshold, the low side switch will be turned off.

AAM mode together with ZCD circuit make MP2148 always work on DCM mode at light load, even if  $V_o$  is closed to  $V_{in}$ .

### Enable

When input voltage is greater than the under-voltage lockout threshold (UVLO), typically 2V, MP2148 can be enabled by pulling EN pin to higher than 1.2V. Leaving EN pin float or pull down to ground will disable MP2148. There is an internal 1Meg Ohm resistor from EN pin to ground.

When the device is disabled, the part goes into output discharge mode automatically and its internal discharge MOSFET provides a resistive discharge path for the output capacitor.

### Soft Start

The MP2148 has a built-in soft start that ramps up the output voltage at a controlled slew rate to avoid overshoot at startup. The soft start time is about 0.5ms typically.

### Power Good Indicator (only for MP2148GQD-XX)

The MP2148 has an open drain and need a external pull-up resistor (100k $\Omega$ ~500k $\Omega$ ) for the power good indicator (Note: Keep PG pull up voltage is lower than V<sub>in</sub>). When V<sub>FB</sub> is within -10% of regulation voltage, V<sub>PG</sub> is pulled up to V<sub>o</sub>/V<sub>in</sub> by the external resistor. If V<sub>FB</sub> exceeds the -10% window, the internal MOSFET pulls the PG to ground. The MOSFET has a maximum R<sub>DS(ON)</sub> of less than 400 $\Omega$ .

### Current limit

The MP2148 typically has a 2.4A high-side switch current limit. When the high side switch hits its current limit, the MP2148 will remain in hiccup mode until the current drops. This prevents the inductor current from continuing to rise and damage components.

### Short Circuit and Recovery

The MP2148 will also enter short-circuit protection mode when it hits the current limit, and tries to recover with hiccup mode: The MP2148 will disable the output power stage, discharge the soft-start capacitor and then automatically try soft-start again. If the short circuit condition remains after soft-start ends, the MP2148 repeats this cycle until the short circuit disappears and output rises back to regulation level.



## APPLICATION INFORMATION

### COMPONENT SELECTION

#### Setting the Output Voltage(Only for MP2148GQD)

The external resistor divider sets the output voltage (see the Typical Application on Figure13). Select the feedback resistor R1 that consider reducing V<sub>OUT</sub> leakage current, typically between 100kΩ to 200kΩ. There is not strict requirement on feedback resistor. Select R1>10kΩ is reasoned for application.

$$R2 = \frac{R1}{\frac{V_{out}}{0.6} - 1}$$

Figure 10 shows the feedback circuit.

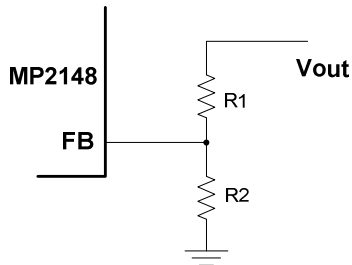


Figure 10: Feedback Network

Table 1 lists the recommended resistors value for common output voltages.

Table 1: Resistor Values for Common Output Voltages

| V <sub>OUT</sub> (V) | R1 (kΩ) | R2 (kΩ)  |
|----------------------|---------|----------|
| 1.0                  | 200(1%) | 300(1%)  |
| 1.2                  | 200(1%) | 200(1%)  |
| 1.8                  | 200(1%) | 100(1%)  |
| 2.5                  | 200(1%) | 63.2(1%) |
| 3.3                  | 200(1%) | 44.2(1%) |

#### Selecting the Inductor

Most applications work best with a 0.47µH to 1.5µH inductor. Select an inductor with a DC resistance less than 15mΩ to optimize efficiency.

High frequency switch mode power supply with magnetic device has strong electronic magnetic inference for system. Any un-shield power inductor should be avoided applying as poor magnetic shielding. Shield inductor, such as

metal alloy or multilayer chip power are best candidates for application, can decrease the influence effectively. Table2 is some suggested inductors.

Table 2: Suggested Inductor List

| Manufacturer P/N | Inductance( µH ) | Manufacturer    |
|------------------|------------------|-----------------|
| PIFE25201B-1R0MS | 1.0              | CYNTEC CO. LTD. |
| 1239AS-H-1R0M    | 1.0              | Tokyo           |
| 74438322010      | 1.0              | Würth           |

For most designs, estimate the inductance value from the following equation.

$$L_1 = \frac{V_{OUT} \times (V_{IN} - V_{OUT})}{V_{IN} \times \Delta I_L \times f_{OSC}}$$

Where ΔI<sub>L</sub> is the inductor ripple current.

Choose an inductor current to be approximately 30% of the maximum load current. The maximum inductor peak current is:

$$I_{L(MAX)} = I_{LOAD} + \frac{\Delta I_L}{2}$$

#### Selecting the Input Capacitor

The input current to the step-down converter is discontinuous, and therefore requires a capacitor to supply the AC current to the step-down converter while maintaining the DC input voltage. Use low ESR capacitors for the best performance. Ceramic capacitors with X5R or X7R dielectrics are highly recommended because of their low ESR and small temperature coefficients. For most applications, a 10µF capacitor is sufficient. Higher output voltages may require a 22µF capacitor to increase system stability.

The input capacitor requires an adequate ripple current rating because it absorbs the input switching current. Estimate the RMS current in the input capacitor with:

$$I_{C1} = I_{LOAD} \times \sqrt{\frac{V_{OUT}}{V_{IN}} \times \left(1 - \frac{V_{OUT}}{V_{IN}}\right)}$$

The worst case occurs at V<sub>IN</sub> = 2V<sub>OUT</sub>, where:

$$I_{C1} = \frac{I_{LOAD}}{2}$$

For simplification, choose an input capacitor with an RMS current rating greater than half of the maximum load current.

The input capacitor can be electrolytic, tantalum or ceramic. When using electrolytic or tantalum capacitors, add a small and high quality ceramic 0.1µF capacitor as close to the IC as possible. When using ceramic capacitors, make sure that they have enough capacitance to provide sufficient charge to prevent excessive voltage ripple at the input. The input voltage ripple caused by capacitance can be estimated as:

$$\Delta V_{IN} = \frac{I_{LOAD}}{f_s \times C1} \times \frac{V_{OUT}}{V_{IN}} \times \left(1 - \frac{V_{OUT}}{V_{IN}}\right)$$

### Selecting the Output Capacitor

The output capacitor (C2) stabilizes the DC output voltage. Ceramic capacitors are recommended. Low ESR capacitors are preferred to limit the output voltage ripple. Estimate the output voltage ripple as:

$$\Delta V_{OUT} = \frac{V_{OUT}}{f_s \times L_1} \times \left(1 - \frac{V_{OUT}}{V_{IN}}\right) \times \left(R_{ESR} + \frac{1}{8 \times f_s \times C2}\right)$$

Where L<sub>1</sub> is the inductor value and R<sub>ESR</sub> is the equivalent series resistance (ESR) value of the output capacitor.

When using ceramic capacitors, the capacitance dominates the impedance at the switching frequency, and causes most of the output voltage ripple. For simplification, the output voltage ripple can be estimated as:

$$\Delta V_{OUT} = \frac{V_{OUT}}{8 \times f_s^2 \times L_1 \times C2} \times \left(1 - \frac{V_{OUT}}{V_{IN}}\right)$$

For tantalum or electrolytic capacitors, the ESR dominates the impedance at the switching frequency. For simplification, the output ripple can be approximated as:

$$\Delta V_{OUT} = \frac{V_{OUT}}{f_s \times L_1} \times \left(1 - \frac{V_{OUT}}{V_{IN}}\right) \times R_{ESR}$$

The characteristics of the output capacitor also affect the stability of the regulation system.

### PCB Layout

Proper layout of the switching power supplies is very important, and sometimes critical for proper function. For the high-frequency switching converter, poor layout design can result in poor line or load regulation and stability issues.

Place the high-current paths (GND, IN and SW) very close to the device with short, direct and wide traces. The input capacitor needs to be as close as possible to the IN and GND pins. Place the external feedback resistors next to the FB pin. Keep the switching node SW short and away from the feedback network. Vout sense line need as short as possible or keeps away from power inductor, especial forbids surrounding inductor. Figure11 is advised PCB layout.



**Figure 11: Two Ends of Input Decoupling Capacitor Close to Pin 2 and Pin3.**

## TYPICAL APPLICATION CIRCUITS



**Figure 12: Typical Application Circuit for MP2148GQD**

Note:  $V_{IN} < 3.3V$  may need more input capacitor.



**Figure 13: Typical Application Circuit for MP2148GQD-XX**

Note: 1.  $V_{IN} < 3.3V$  may need more input capacitor;

2.  $V_{IN} > V_{OUT}$  for application.

## PACKAGE INFORMATION

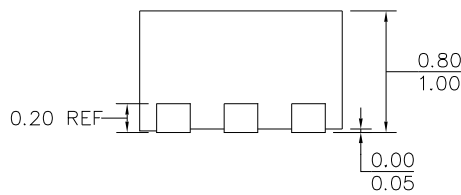
### QFN-6 (1.0mmx1.5mm)



TOP VIEW



BOTTOM VIEW



SIDE VIEW



RECOMMENDED LAND PATTERN

#### NOTE:

- 1) ALL DIMENSIONS ARE IN MILLIMETERS.
- 2) EXPOSED PADDLE SIZE DOES NOT INCLUDE MOLD FLASH.
- 3) LEAD COPLANARITY SHALL BE 0.10 MILLIMETERS MAX.
- 4) JEDEC REFERENCE IS MO-220.
- 5) DRAWING IS NOT TO SCALE.

**NOTICE:** The information in this document is subject to change without notice. Please contact MPS for current specifications. Users should warrant and guarantee that third party Intellectual Property rights are not infringed upon when integrating MPS products into any application. MPS will not assume any legal responsibility for any said applications.