

## LP5907 250mA 低噪声、低 I<sub>Q</sub> LDO

### 1 特性

- 有关更新的器件产品组合，请参阅 [TPS7A20](#)
- 输入电压范围：2.2V 至 5.5V
- 输出电压范围：1.2V 至 4.5V
- 与 1 $\mu$ F 陶瓷输入和输出电容搭配使用，性能稳定
- 无需噪声旁路电容
- 支持远距离安置输出电容
- 具备热过载和短路保护功能
- 工作结温：-40°C 至 125°C
- 低输出电压噪声：< 6.5 $\mu$ V<sub>RMS</sub>
- PSRR：1kHz 时为 82dB
- 输出电压容差： $\pm$ 2%
- 极低 I<sub>Q</sub>（使能时）：12  $\mu$ A
- 低压降：120mV（典型值）
- 使用 LP5907 并借助 [WEBENCH® Power Designer](#) 创建定制设计方案

### 2 应用

- [智能手机](#)
- [平板电脑](#)
- [通信设备](#)
- [数码相机](#)
- [工厂自动化](#)

### 3 说明

LP5907 是一款能提供高达 250mA 输出电流的低噪声 LDO。LP5907 符合射频和模拟电路要求，可提供低噪声、高 PSRR、低静态电流以及低线路或负载瞬态响应系数。LP5907 采用创新的设计技术，无需噪声旁路电容便可提供出色的噪声性能，并且支持远距离安置输出电容。

此器件可与 1 $\mu$ F 输入和 1 $\mu$ F 输出陶瓷电容搭配使用（无需独立的噪声旁路电容）。

其固定输出电压介于 1.2V 和 4.5V 之间（阶跃为 25mV）。如需特定的电压选项，请联系德州仪器 (TI) 销售代表。

#### 封装信息

器件型号	封装 <sup>(1)</sup>	封装尺寸 <sup>(2)</sup>
LP5907	YKE、YKG、YKM、YCR (DSBGA, 4)	0.685mm × 0.685mm
	DBV (SOT-23, 5)	2.9mm × 2.8mm
	DQN (X2SON, 4)	1mm × 1mm

(1) 如需更多信息，请参阅 [机械、封装和可订购信息](#)。

(2) 封装尺寸（长 × 宽）为标称值，并包括引脚（如适用）。

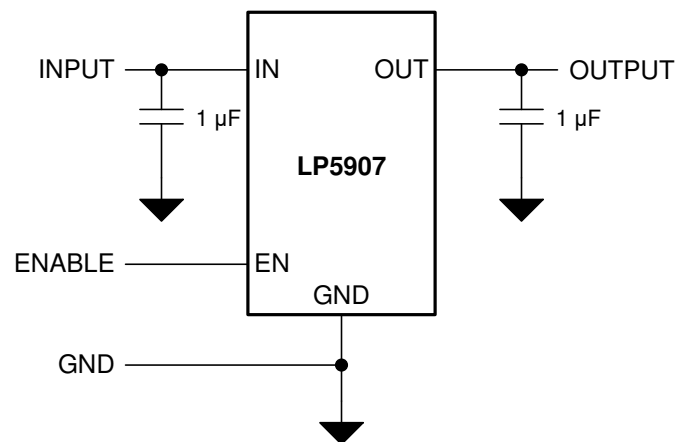

简化版原理图



## Table of Contents

<b>1 特性</b> .....	1	6.4 Device Functional Modes.....	12
<b>2 应用</b> .....	1	<b>7 Application and Implementation</b> .....	13
<b>3 说明</b> .....	1	7.1 Application Information.....	13
<b>4 Pin Configuration and Functions</b> .....	3	7.2 Typical Application.....	13
<b>5 Specifications</b> .....	4	7.3 Power Supply Recommendations.....	16
5.1 Absolute Maximum Ratings.....	4	7.4 Layout.....	17
5.2 ESD Ratings.....	4	<b>8 Device and Documentation Support</b> .....	19
5.3 Recommended Operating Conditions.....	4	8.1 Documentation Support.....	19
5.4 Thermal Information.....	5	8.2 接收文档更新通知.....	19
5.5 Electrical Characteristics.....	5	8.3 支持资源.....	19
5.6 Output and Input Capacitors.....	6	8.4 Trademarks.....	19
5.7 Typical Characteristics.....	7	8.5 静电放电警告.....	19
<b>6 Detailed Description</b> .....	11	8.6 术语表.....	19
6.1 Overview.....	11	<b>9 Revision History</b> .....	20
6.2 Functional Block Diagram.....	11	<b>10 Mechanical, Packaging, and Orderable Information</b> .....	20
6.3 Feature Description.....	11		

## 4 Pin Configuration and Functions



图 4-1. YKE, YKG, YKM, and YCR Packages, 4-Pin DSBGA

表 4-1. Pin Functions: DSBGA

PIN		TYPE	DESCRIPTION
DSBGA	NAME		
A1	IN	I	Input voltage supply. Connect a 1μF capacitor at this input.
A2	OUT	O	Regulated output voltage. Connect a minimum 1μF low-ESR capacitor to this pin. Connect this output to the load circuit. An internal 230 Ω (typical) pulldown resistor prevents a charge remaining on V <sub>OUT</sub> when the regulator is in the shutdown mode (V <sub>EN</sub> low).
B1	EN	I	Enable input. A low voltage (< V <sub>IL</sub> ) on this pin turns the regulator off and discharges the output pin to GND through an internal 230 Ω pulldown resistor. A high voltage (> V <sub>IH</sub> ) on this pin enables the regulator output. This pin has an internal 1M Ω pulldown resistor to hold the regulator off by default.
B2	GND	—	Common ground

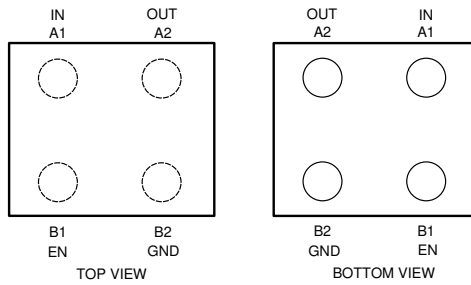

图 4-2. DQN Package, 4-Pin X2SON (Bottom View)



图 4-3. DBV Package, 5-Pin SOT-23 (Top View)

表 4-2. Pin Functions: X2SON, SOT-23

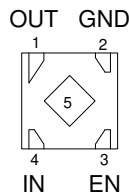
PIN			TYPE	DESCRIPTION
NAME	X2SON	SOT-23		
EN	3	3	I	Enable input. A low voltage (< V <sub>IL</sub> ) on this pin turns the regulator off and discharges the output pin to GND through an internal 230 Ω pulldown resistor. A high voltage (> V <sub>IH</sub> ) on this pin enables the regulator output. This pin has an internal 1M Ω pulldown resistor to hold the regulator off by default.
GND	2	2	—	Common ground.
IN	4	1	I	Input voltage supply. Connect a 1μF capacitor at this input.
N/C	—	4	—	No internal electrical connection.
OUT	1	5	O	Regulated output voltage. Connect a minimum 1μF low-ESR capacitor to this pin. Connect this output to the load circuit. An internal 230 Ω (typical) pulldown resistor prevents a charge remaining on V <sub>OUT</sub> when the regulator is in shutdown mode (V <sub>EN</sub> low).
Thermal Pad	5	—	—	Thermal pad for the X2SON package, connect to GND or leave floating. Do not connect to any potential other than GND.

## 5 Specifications

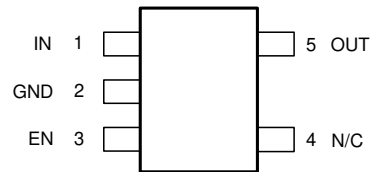
### 5.1 Absolute Maximum Ratings

over operating free-air temperature range (unless otherwise noted)<sup>(1) (3)</sup>

		MIN	MAX	UNIT
V <sub>IN</sub>	Input voltage	- 0.3	6	V
V <sub>OUT</sub>	Output voltage	- 0.3	See <sup>(2)</sup>	V
V <sub>EN</sub>	Enable input voltage	- 0.3	6	V
	Continuous power dissipation <sup>(4)</sup>	Internally limited		W
T <sub>JMAX</sub>	Junction temperature		150	°C
T <sub>stg</sub>	Storage temperature	- 65	150	°C

- (1) Stresses beyond those listed under *Absolute Maximum Ratings* may cause permanent damage to the device. These are stress ratings only, and functional operation of the device at these or any other conditions beyond those indicated under the *Recommended Operating Conditions* is not implied. Exposure to absolute-maximum-rated conditions for extended periods may affect device reliability.
- (2) Abs Max V<sub>OUT</sub> is the lessor of V<sub>IN</sub> + 0.3V, or 6V.
- (3) All voltages are with respect to the GND pin.
- (4) Internal thermal shutdown circuitry protects the device from permanent damage.

### 5.2 ESD Ratings

			VALUE	UNIT
V <sub>(ESD)</sub>	Electrostatic discharge	Human-body model (HBM), per ANSI/ESDA/JEDEC JS-001 <sup>(1)</sup>	±2000	V
		Charged-device model (CDM), per JEDEC specification JESD22-C101 <sup>(2)</sup>	±1000	

- (1) JEDEC document JEP155 states that 500V HBM allows safe manufacturing with a standard ESD control process.
- (2) JEDEC document JEP157 states that 250V CDM allows safe manufacturing with a standard ESD control process.

### 5.3 Recommended Operating Conditions

over operating free-air temperature range (unless otherwise noted)<sup>(1) (2)</sup>

		MIN	MAX	UNIT
V <sub>IN</sub>	Input supply voltage	2.2	5.5	V
V <sub>EN</sub>	Enable input voltage	0	5.5	V
I <sub>OUT</sub>	Output current	0	250	mA
T <sub>J</sub>	Junction temperature	- 40	125	°C
T <sub>A</sub>	Ambient temperature <sup>(3)</sup>	- 40	85	°C

- (1) Stresses beyond those listed under *Absolute Maximum Ratings* may cause permanent damage to the device. These are stress ratings only, and functional operation of the device at these or any other conditions beyond those indicated under *Recommended Operating Conditions* is not implied. Exposure to absolute-maximum-rated conditions for extended periods may affect device reliability.
- (2) All voltages are with respect to the GND pin.
- (3) In applications where high power dissipation and poor package thermal resistance is present, the maximum ambient temperature can need to be derated. Maximum ambient temperature (T<sub>A-MAX</sub>) is dependent on the maximum operating junction temperature (T<sub>J-MAX-OP</sub> = 125°C), the maximum power dissipation of the device in the application (P<sub>D-MAX</sub>), and the junction-to ambient thermal resistance of the device or package in the application (R<sub>θJA</sub>), as given by the following equation: T<sub>A-MAX</sub> = T<sub>J-MAX-OP</sub> - (R<sub>θJA</sub> × P<sub>D-MAX</sub>). See the [Application and Implementation](#) section.

## 5.4 Thermal Information

THERMAL METRIC <sup>(1)</sup>		LP5907						UNIT
		DBV (SOT-23)	DQN (X2SON)	YCR (DSBGA)	YKE (DSBGA)	YKG (DSBGA)	YKM (DSBGA)	
		5 PINS	4 PINS	4 PINS	4 PINS	4 PINS	4 PINS	
$R_{\theta JA}$	Junction-to-ambient thermal resistance	193.4	216.1	189.4	206.1	191.6	194.1	°C/W
$R_{\theta JC(top)}$	Junction-to-case (top) thermal resistance	102.1	161.7	2.4	1.5	2.4	3.0	°C/W
$R_{\theta JB}$	Junction-to-board thermal resistance	45.8	162.1	56.6	37.0	58.9	62.7	°C/W
$\psi_{JT}$	Junction-to-top characterization parameter	8.4	5.1	1.1	15.0	1.1	1.1	°C/W
$\psi_{JB}$	Junction-to-board characterization parameter	45.3	161.7	56.5	36.8	58.9	62.7	°C/W
$R_{\theta JC(bot)}$	Junction-to-case (bottom) thermal resistance	n/a	123.0	n/a	n/a	n/a	n/a	°C/W

(1) For more information about traditional and new thermal metrics, see the [Semiconductor and IC Package Thermal Metrics application note](#).

## 5.5 Electrical Characteristics

$V_{IN} = V_{OUT(NOM)} + 1V$ ,  $V_{EN} = 1.2V$ ,  $I_{OUT} = 1mA$ ,  $C_{IN} = 1\mu F$ , and  $C_{OUT} = 1\mu F$  (unless otherwise noted)<sup>(1) (2) (3)</sup>

PARAMETER		TEST CONDITIONS	MIN	TYP	MAX	UNIT
$V_{IN}$	Input voltage	$T_A = 25^\circ C$	2.2		5.5	V
$\Delta V_{OUT}$	Output voltage tolerance	$V_{IN} = (V_{OUT(NOM)} + 1V)$ to 5.5V, $I_{OUT} = 1mA$ to 250mA	-2		2	% $V_{OUT}$
		$V_{IN} = (V_{OUT(NOM)} + 1V)$ to 5.5V, $I_{OUT} = 1mA$ to 250mA ( $V_{OUT} < 1.8V$ , SOT-23, X2SON packages)	-3		3	
	Line regulation	$V_{IN} = (V_{OUT(NOM)} + 1V)$ to 5.5V, $I_{OUT} = 1mA$		0.02		%/V
	Load regulation	$I_{OUT} = 1mA$ to 250mA		0.001		%/mA
$I_{LOAD}$	Load current	See <sup>(4)</sup>	0		250	mA
	Maximum output current		250			
$I_Q$	Quiescent current <sup>(5)</sup>	$V_{EN} = 1.2V$ , $I_{OUT} = 0mA$		12	25	$\mu A$
		$V_{EN} = 1.2V$ , $I_{OUT} = 250mA$		250	425	
		$V_{EN} = 0.3V$ (disabled)		0.2	1	
$I_G$	Ground current <sup>(6)</sup>	$V_{EN} = 1.2V$ , $I_{OUT} = 0mA$		14		$\mu A$
$V_{DO}$	Dropout voltage <sup>(7)</sup>	$I_{OUT} = 100mA$		50		mV
		$I_{OUT} = 250mA$ (DSBGA package)		120	200	
		$I_{OUT} = 250mA$ (SOT-23, X2SON packages)			250	
$I_{SC}$	Short-circuit current limit	$T_A = 25^\circ C$ <sup>(8)</sup>	250	500		mA
PSRR	Power-supply rejection ratio <sup>(9)</sup>	$f = 100Hz$ , $I_{OUT} = 20mA$		90		dB
		$f = 1kHz$ , $I_{OUT} = 20mA$		82		
		$f = 10kHz$ , $I_{OUT} = 20mA$		65		
		$f = 100kHz$ , $I_{OUT} = 20mA$		60		
$e_N$	Output noise voltage <sup>(9)</sup>	BW = 10Hz to 100kHz	$I_{OUT} = 1mA$		10	$\mu V_{RMS}$
			$I_{OUT} = 250mA$		6.5	
$R_{AD}$	Output automatic discharge pulldown resistance	$V_{EN} < V_{IL}$ (output disabled)		230		$\Omega$
$T_{SD}$	Thermal shutdown	$T_J$ rising		160		°C
	Thermal hysteresis	$T_J$ falling from shutdown		15		
<b>LOGIC INPUT THRESHOLDS</b>						

## 5.5 Electrical Characteristics (续)

$V_{IN} = V_{OUT(NOM)} + 1V$ ,  $V_{EN} = 1.2V$ ,  $I_{OUT} = 1mA$ ,  $C_{IN} = 1\mu F$ , and  $C_{OUT} = 1\mu F$  (unless otherwise noted)<sup>(1) (2) (3)</sup>

PARAMETER		TEST CONDITIONS	MIN	TYP	MAX	UNIT
$V_{IL}$	Low input threshold	$V_{IN} = 2.2V$ to $5.5V$ , $V_{EN}$ falling until the output is disabled			0.4	V
$V_{IH}$	High input threshold	$V_{IN} = 2.2V$ to $5.5V$ $V_{EN}$ rising until the output is enabled	1.2			V
$I_{EN}$	Input current at EN pin <sup>(10)</sup>	$V_{EN} = 5.5V$ and $V_{IN} = 5.5V$		5.5		$\mu A$
		$V_{EN} = 0V$ and $V_{IN} = 5.5V$		0.001		
<b>TRANSIENT CHARACTERISTICS</b>						
$\Delta V_{OUT}$	Line transient <sup>(9)</sup>	$V_{IN} = (V_{OUT(NOM)} + 1V)$ to $(V_{OUT(NOM)} + 1.6V)$ in $30\mu s$	-1			mV
		$V_{IN} = (V_{OUT(NOM)} + 1.6V)$ to $(V_{OUT(NOM)} + 1.6V)$ in $30\mu s$			1	
	Load transient <sup>(9)</sup>	$I_{OUT} = 1mA$ to $250mA$ in $10\mu s$	-40			
		$I_{OUT} = 250mA$ to $1mA$ in $10\mu s$			40	
	Overshoot on start-up <sup>(9)</sup>	Stated as a percentage of $V_{OUT(NOM)}$			5%	
Overshoot on start-up with EN <sup>(9)</sup>	Stated as a percentage of $V_{OUT(NOM)}$ , $V_{IN} = V_{OUT} + 1V$ to $5.5V$ , $0.7\mu F < C_{OUT} < 10\mu F$ , $0mA < I_{OUT} < 250mA$ , EN rising until the output is enabled			1%		
$t_{ON}$	Turn-on time	From $V_{EN} > V_{IH}$ to $V_{OUT} = 95%$ of $V_{OUT(NOM)}$ , $T_A = 25^\circ C$		80	150	$\mu s$

- (1) All voltages are with respect to the device GND terminal, unless otherwise stated.
- (2) Minimum and maximum limits are specified through test, design, or statistical correlation over the junction temperature ( $T_J$ ) range of  $-40^\circ C$  to  $125^\circ C$ , unless otherwise stated. Typical values represent the most likely parametric norm at  $T_A = 25^\circ C$ , and are provided for reference purposes only.
- (3) In applications where high power dissipation or poor package thermal resistance is present, the maximum ambient temperature can possibly have to be derated. Maximum ambient temperature ( $T_{A-MAX}$ ) is dependent on the maximum operating junction temperature ( $T_{J-MAX-OP} = 125^\circ C$ ), the maximum power dissipation of the device in the application ( $P_{D-MAX}$ ), and the junction-to ambient thermal resistance of the device or package in the application ( $R_{\theta JA}$ ), as given by the following equation:  $T_{A-MAX} = T_{J-MAX-OP} - (R_{\theta JA} \times P_{D-MAX})$ . See the [Application and Implementation](#) section.
- (4) The device maintains a stable, regulated output voltage without a load current.
- (5) Quiescent current is defined here as the difference in current between the input voltage source and the load at  $V_{OUT}$ .
- (6) Ground current is defined here as the total current flowing to ground as a result of all input voltages applied to the device.
- (7) Dropout voltage is the voltage difference between the input and the output at which the output voltage drops to 100mV below the nominal value.
- (8) Short-circuit current ( $I_{SC}$ ) for the LP5907 is equivalent to current limit. To minimize thermal effects during testing,  $I_{SC}$  is measured with  $V_{OUT}$  pulled to 100mV below the nominal voltage.
- (9) This specification is verified by design.
- (10) There is a  $1M\Omega$  resistor between EN and ground on the device.

## 5.6 Output and Input Capacitors

over operating free-air temperature range (unless otherwise noted)

PARAMETER		TEST CONDITIONS	MIN <sup>(1)</sup>	TYP	MAX	UNIT
$C_{IN}$	Input capacitance <sup>(2)</sup>	Capacitance for stability	0.7	1		$\mu F$
$C_{OUT}$	Output capacitance <sup>(2)</sup>		0.7	1	10	$\mu F$
ESR	Output/Input capacitance <sup>(2)</sup>		5		500	$m\Omega$

- (1) The minimum capacitance must be greater than  $0.5\mu F$  over the full range of operating conditions. The capacitor tolerance must be 30% or better over the full temperature range. The full range of operating conditions for the capacitor in the application must be considered during device selection to make sure this minimum capacitance specification is met. X7R capacitors are recommended, however capacitor types X5R, Y5V, and Z5U can be used with consideration of the application and conditions.
- (2) This specification is verified by design.

### 5.7 Typical Characteristics

$V_{IN} = 3.7V$ ,  $V_{OUT} = 2.8V$ ,  $I_{OUT} = 1mA$ ,  $C_{IN} = 1\mu F$ ,  $C_{OUT} = 1\mu F$ , and  $T_A = 25^\circ C$  (unless otherwise noted)



图 5-1. Quiescent Current vs Input Voltage



图 5-2.  $V_{EN}$  Thresholds vs  $V_{IN}$

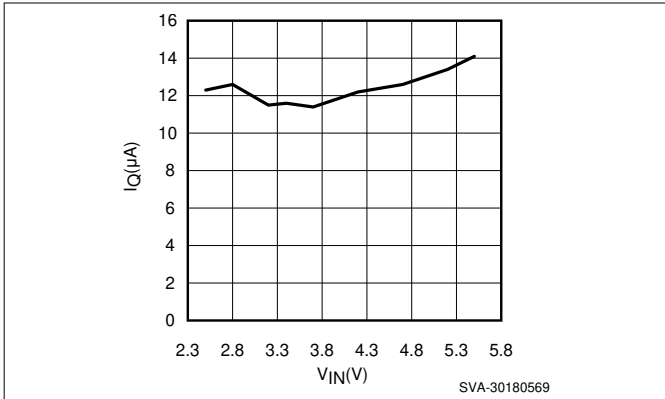

图 5-3.  $V_{OUT}$  vs  $V_{IN}$

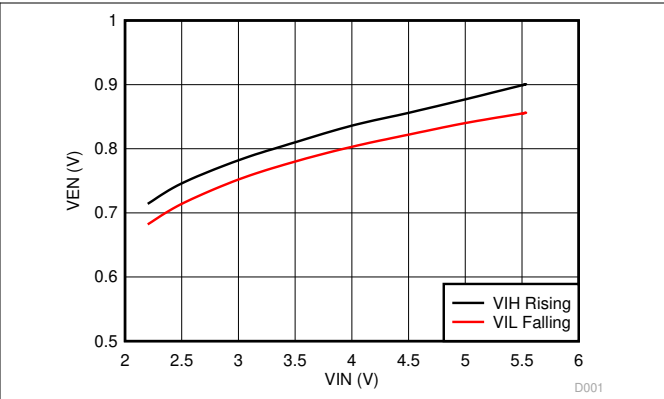

图 5-4.  $V_{OUT}$  vs  $V_{IN}$

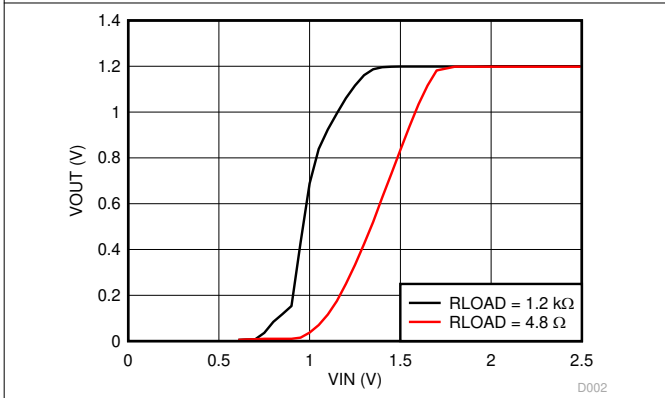

图 5-5. Ground Current vs Output Current

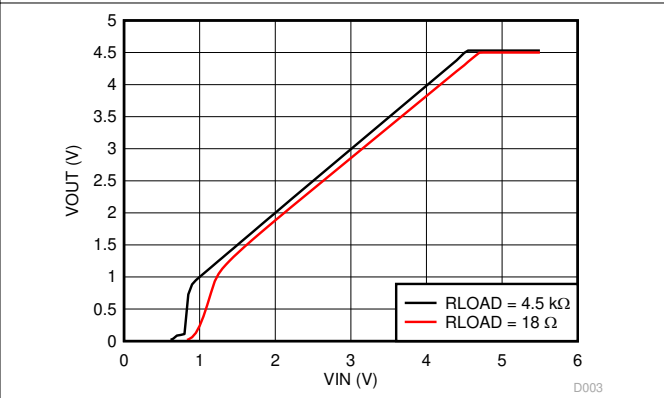

图 5-6. Load Regulation

### 5.7 Typical Characteristics (continued)

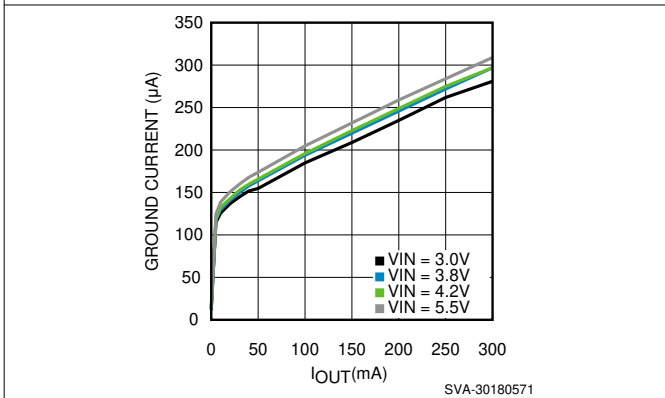
$V_{IN} = 3.7V$ ,  $V_{OUT} = 2.8V$ ,  $I_{OUT} = 1mA$ ,  $C_{IN} = 1\mu F$ ,  $C_{OUT} = 1\mu F$ , and  $T_A = 25^\circ C$  (unless otherwise noted)

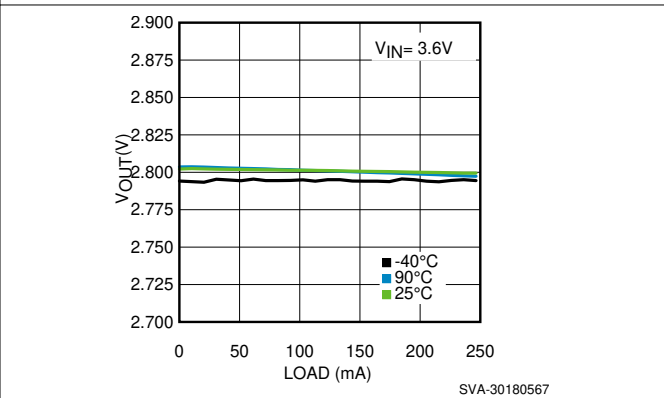

图 5-7.  $\Delta V_{OUT}$  vs Temperature



图 5-8. Line Regulation

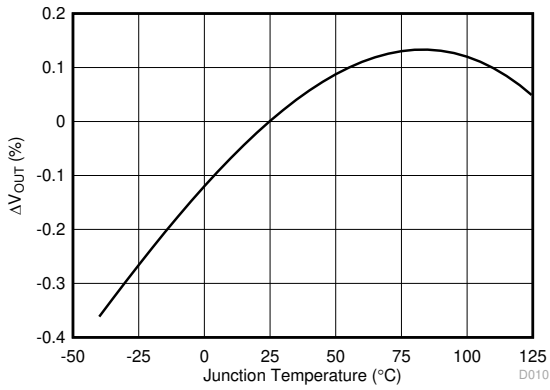

图 5-9. Inrush Current

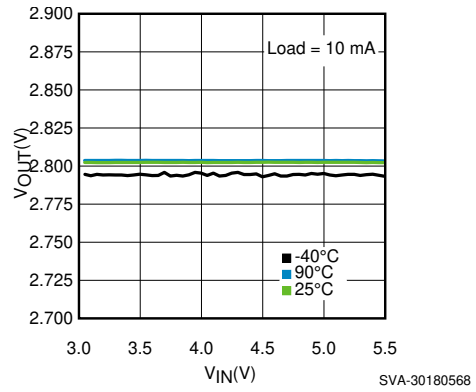

$V_{IN} = 3.2V \leftrightarrow 4.2V$ , load = 1mA

图 5-10. Line Transient

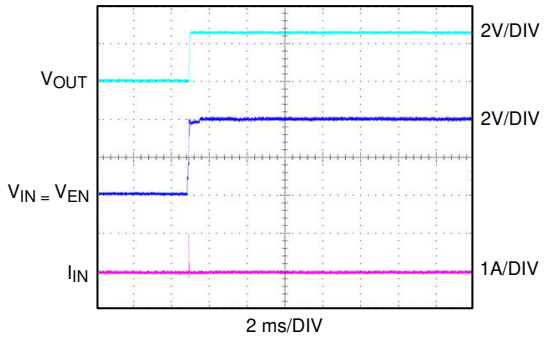
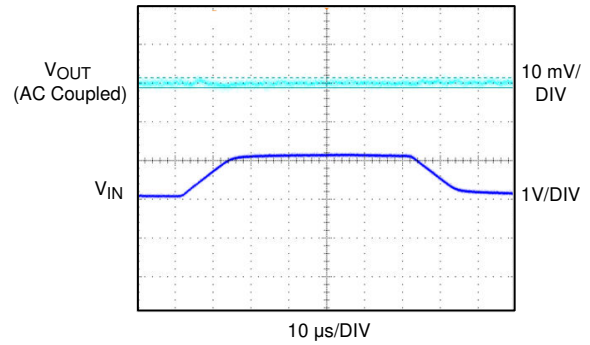
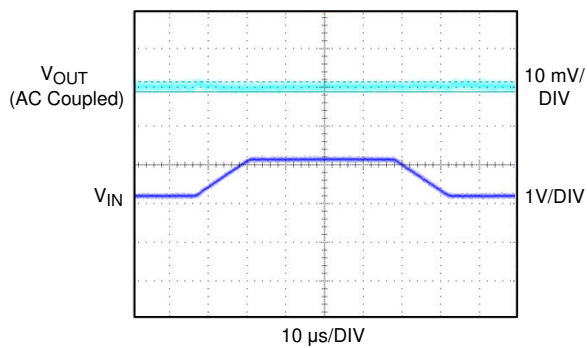

$V_{IN} = 3.2V \leftrightarrow 4.2V$ , load = 250mA

图 5-11. Line Transient

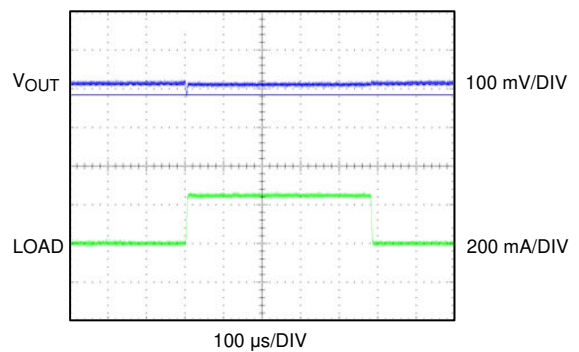

Load = 0mA  $\leftrightarrow$  250mA,  $-40^\circ C$

图 5-12. Load Transient



### 5.7 Typical Characteristics (continued)

$V_{IN} = 3.7V$ ,  $V_{OUT} = 2.8V$ ,  $I_{OUT} = 1mA$ ,  $C_{IN} = 1\mu F$ ,  $C_{OUT} = 1\mu F$ , and  $T_A = 25^\circ C$  (unless otherwise noted)

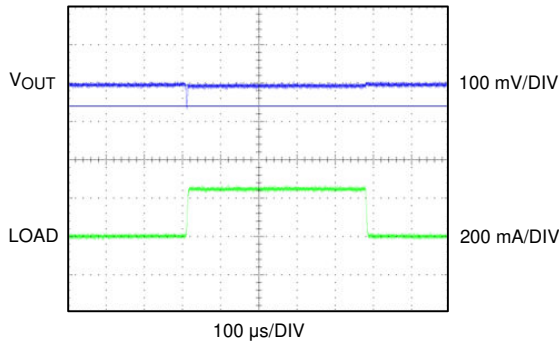

SVA-30180513

Load = 0mA ↔ 250mA, 90°C

图 5-13. Load Transient

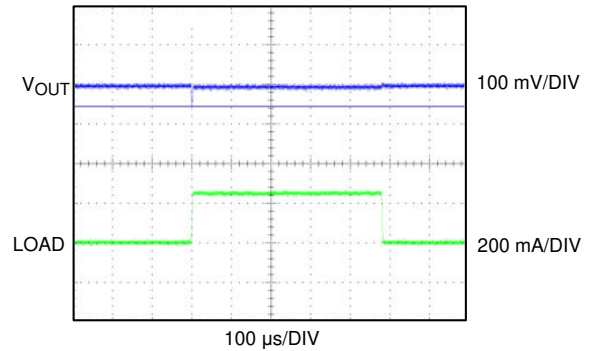

SVA-30180514

Load = 0mA ↔ 250mA, 25°C

图 5-14. Load Transient

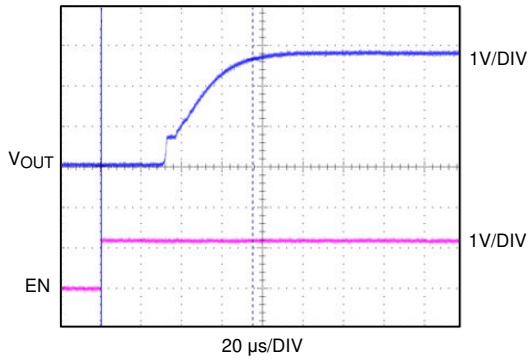

SVA-30180515

Load = 0mA

图 5-15. Start-Up

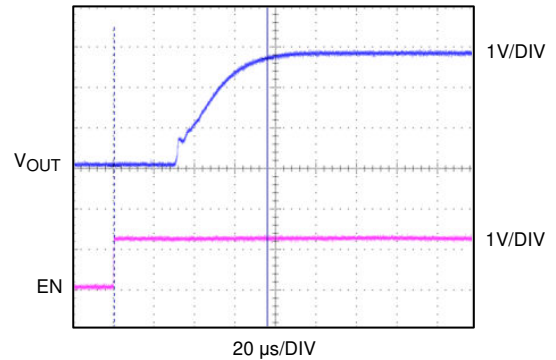

SVA-30180516

Load = 250mA

图 5-16. Start-Up



图 5-17. Noise Density Test



SVA-30180573

图 5-18. Dropout Voltage vs Load Current

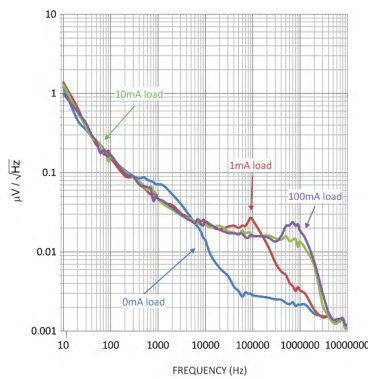
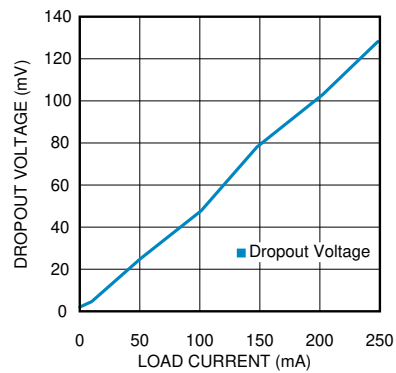
### 5.7 Typical Characteristics (continued)

$V_{IN} = 3.7V$ ,  $V_{OUT} = 2.8V$ ,  $I_{OUT} = 1mA$ ,  $C_{IN} = 1\mu F$ ,  $C_{OUT} = 1\mu F$ , and  $T_A = 25^\circ C$  (unless otherwise noted)

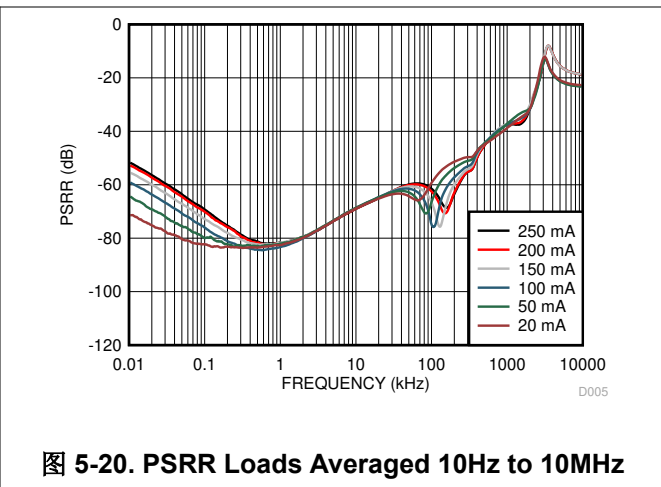
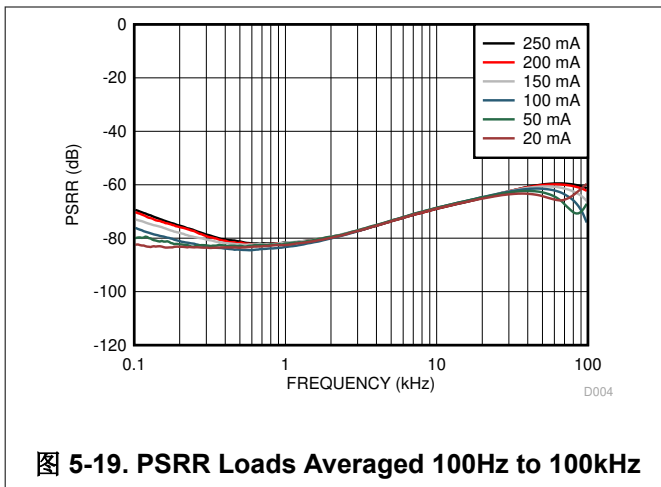

## 6 Detailed Description

### 6.1 Overview

Designed to meet the needs of sensitive RF and analog circuits, the LP5907 provides low noise, high PSRR, low quiescent current, and low line and load transient response figures. Using innovative design techniques, the LP5907 offers class leading noise performance without the need for a separate noise filter capacitor.

The LP5907 is designed to perform with a single  $1\mu\text{F}$  input capacitor and a single  $1\mu\text{F}$  ceramic output capacitor. With a reasonable PCB layout, the single  $1\mu\text{F}$  ceramic output capacitor can be placed up to 10cm away from the LP5907 device.

### 6.2 Functional Block Diagram

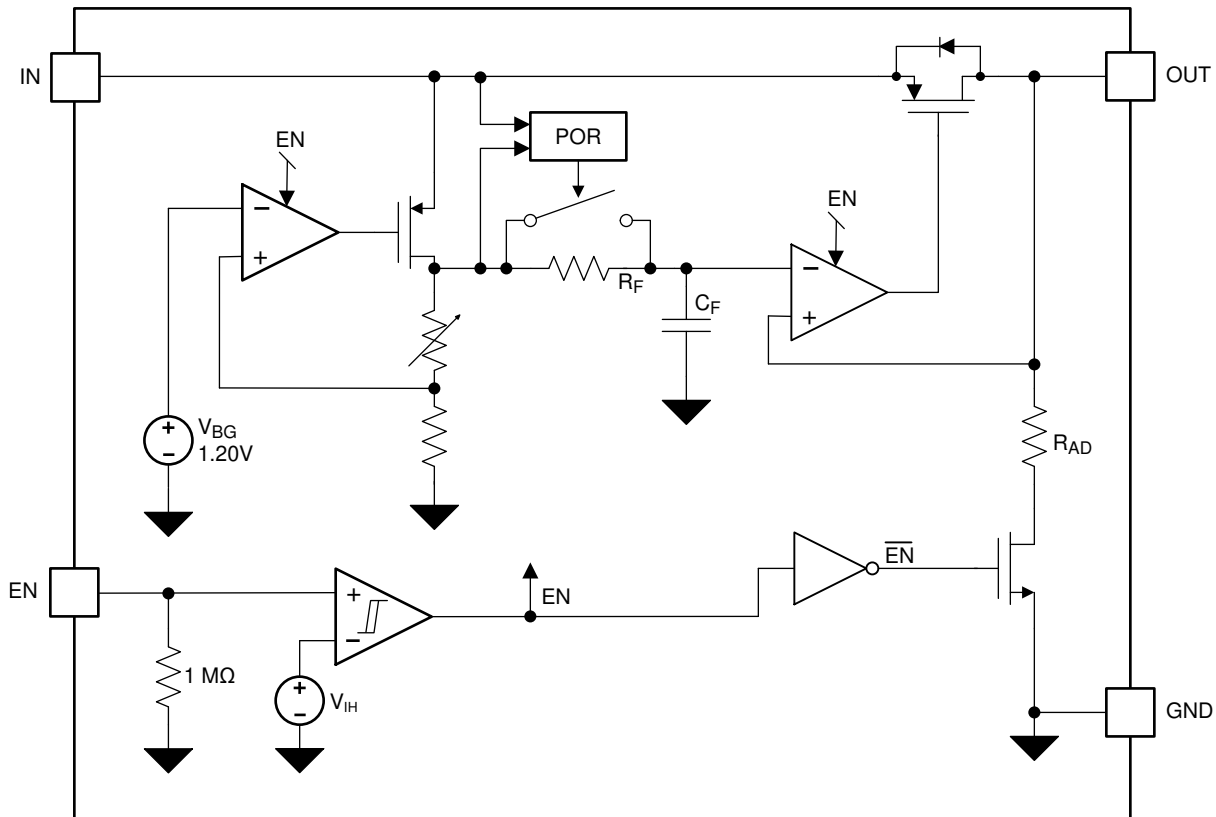

### 6.3 Feature Description

#### 6.3.1 Enable (EN)

The LP5907 EN pin is internally held low by a  $1\text{M}\Omega$  resistor to GND. The EN pin voltage must be higher than the  $V_{IH}$  threshold to make sure that the device is fully enabled under all operating conditions. The EN pin voltage must be lower than the  $V_{IL}$  threshold to make sure that the device is fully disabled and the automatic output discharge is activated.

#### 6.3.2 Low Output Noise

Any internal noise at the LP5907 reference voltage is reduced by a first-order, low-pass RC filter before being passed to the output buffer stage. The low-pass RC filter has a  $-3\text{-dB}$  cut-off frequency of approximately 0.1Hz.

#### 6.3.3 Output Automatic Discharge

The LP5907 output employs an internal  $230\Omega$  (typical) pulldown resistance to discharge the output when the EN pin is low and the device is disabled.

### 6.3.4 Remote Output Capacitor Placement

The LP5907 requires at least a 1 $\mu$ F capacitor at the OUT pin, but there are no strict requirements about the location of the capacitor in regards to the OUT pin. In practical designs, the output capacitor can be located up to 10cm away from the LDO.

### 6.3.5 Thermal Overload Protection ( $T_{SD}$ )

Thermal shutdown disables the output when the junction temperature rises to approximately 160°C, which allows the device to cool. When the junction temperature cools to approximately 145°C, the output circuitry enables. Based on power dissipation, thermal resistance, and ambient temperature, the thermal protection circuit can cycle on and off. This thermal cycling limits the dissipation of the regulator, and protects the regulator from damage as a result of overheating.

The thermal shutdown circuitry of the LP5907 is designed to protect against temporary thermal overload conditions. The  $T_{SD}$  circuitry is not intended to replace proper heat-sinking. Continuously running the LP5907 into thermal shutdown can degrade device reliability.

## 6.4 Device Functional Modes

### 6.4.1 Enable (EN)

The LP5907 enable (EN) pin is internally held low by a 1M $\Omega$  resistor to GND. The EN pin voltage must be higher than the  $V_{IH}$  threshold to make sure that the device is fully enabled under all operating conditions.

When the EN pin is pulled low, and the output is disabled, the output automatic discharge circuitry is activated. Any charge on the OUT pin is discharged to GND through the internal 230 $\Omega$  (typical) pulldown resistance.

### 6.4.2 Minimum Operating Input Voltage ( $V_{IN}$ )

The LP5907 does not include any dedicated UVLO circuitry. The LP5907 internal circuitry is not fully functional until  $V_{IN}$  is at least 2.2V. The output voltage is not regulated until  $V_{IN}$  has reached at least the greater of 2.2V or ( $V_{OUT} + V_{DO}$ ).

## 7 Application and Implementation

### 备注

以下应用部分中的信息不属于 TI 器件规格的范围，TI 不担保其准确性和完整性。TI 的客户应负责确定器件是否适用于其应用。客户应验证并测试其设计，以确保系统功能。

### 7.1 Application Information

The LP5907 is designed to meet the requirements of RF and analog circuits, by providing low noise, high PSRR, low quiescent current, and low line or load transient response figures. The device offers excellent noise performance without the need for a noise bypass capacitor and is stable with input and output capacitors with a value of  $1\mu\text{F}$ . The LP5907 delivers this performance in industry standard packages such as DSBGA, X2SON, and SOT-23 which, for this device, are specified with an operating junction temperature ( $T_J$ ) of  $-40^\circ\text{C}$  to  $125^\circ\text{C}$ .

### 7.2 Typical Application

图 7-1 shows the typical application circuit for the LP5907. Input and output capacitances can be increased, if needed, above the  $1\mu\text{F}$  minimum for some applications.



图 7-1. LP5907 Typical Application

#### 7.2.1 Design Requirements

表 7-1 summarizes the design requirements for 图 7-1.

表 7-1. Design Parameters

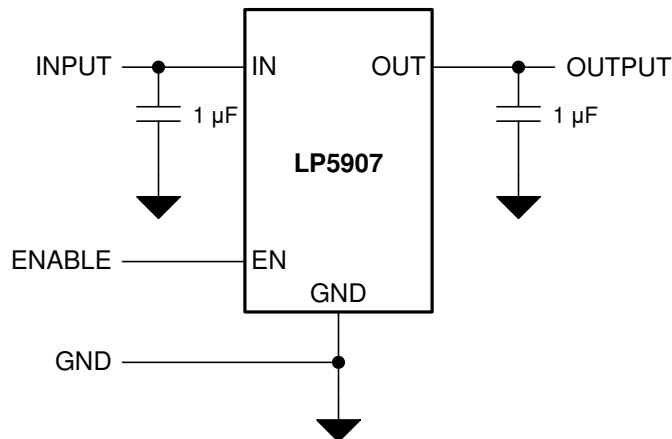
DESIGN PARAMETER	EXAMPLE VALUE
Input voltage range	2.2V to 5.5V
Output voltage	1.8V
Output current	200mA
Output capacitor range	$0.7\mu\text{F}$ to $10\mu\text{F}$
Input/output capacitor ESR range	$5\text{m}\Omega$ to $500\text{m}\Omega$

## 7.2.2 Detailed Design Procedure

### 7.2.2.1 Custom Design With WEBENCH® Tools

Click [here](#) to create a custom design using the LP5907 device with the WEBENCH® Power Designer.

1. Start by entering the input voltage ( $V_{IN}$ ), output voltage ( $V_{OUT}$ ), and output current ( $I_{OUT}$ ) requirements.
2. Optimize the design for key parameters such as efficiency, footprint, and cost using the optimizer dial.
3. Compare the generated design with other possible solutions from Texas Instruments.

The WEBENCH Power Designer provides a customized schematic along with a list of materials with real-time pricing and component availability.

In most cases, these actions are available:

- Run electrical simulations to see important waveforms and circuit performance
- Run thermal simulations to understand board thermal performance
- Export customized schematic and layout into popular CAD formats
- Print PDF reports for the design, and share the design with colleagues

Get more information about WEBENCH tools at [www.ti.com/WEBENCH](http://www.ti.com/WEBENCH).

#### 7.2.2.2 Power Dissipation and Device Operation

The permissible power dissipation for any package is a measure of the capability of the device to pass heat from the power source, the junctions of the device, to the ultimate heat sink, the ambient environment. Thus, the power dissipation is dependent on the ambient temperature and the thermal resistance across the various interfaces between the die junction and ambient air.

The maximum allowable power dissipation for the device in a given package can be calculated using [方程式 1](#):

$$P_{D-MAX} = ((T_{J-MAX} - T_A) / R_{\theta JA}) \quad (1)$$

The actual power being dissipated in the device can be represented by [方程式 2](#):

$$P_D = (V_{IN} - V_{OUT}) \times I_{OUT} \quad (2)$$

These two equations establish the relationship between the maximum power dissipation allowed in regards to thermal consideration, the voltage drop across the device, and the continuous current capability of the device. Use these two equations to determine the optimum operating conditions for the device in the application.

In applications where lower power dissipation ( $P_D$ ) or excellent package thermal resistance ( $R_{\theta JA}$ ) is present, the maximum ambient temperature ( $T_{A-MAX}$ ) can be increased.

In applications where high power dissipation or poor package thermal resistance is present, the maximum ambient temperature ( $T_{A-MAX}$ ) can be derated.  $T_{A-MAX}$  is dependent on the maximum operating junction temperature ( $T_{J-MAX-OP} = 125^\circ\text{C}$ ), the maximum allowable power dissipation in the device package in the application ( $P_{D-MAX}$ ), and the junction-to ambient thermal resistance of the device or package in the application ( $R_{\theta JA}$ ), as given by [方程式 3](#):

$$T_{A-MAX} = (T_{J-MAX-OP} - (R_{\theta JA} \times P_{D-MAX})) \quad (3)$$

Alternately, if  $T_{A-MAX}$  cannot be derated, the  $P_D$  value must be reduced. This reduction can be accomplished by reducing  $V_{IN}$  in the  $V_{IN} - V_{OUT}$  term as long as the minimum  $V_{IN}$  is met, or by reducing the  $I_{OUT}$  term, or by some combination of the two.

#### 7.2.2.3 External Capacitors

Like most low-dropout regulators, the LP5907 requires external capacitors for regulator stability. The device is specifically designed for portable applications requiring minimum board space and smallest components. These capacitors must be correctly selected for good performance.

#### 7.2.2.4 Input Capacitor

An input capacitor is required for stability. The input capacitor must be at least equal to, or greater than, the output capacitor for good load transient performance. Connect at least a 1 $\mu$ F capacitor between the LP5907 input pin and ground for stable operation over the full load current range. Basically, having more output capacitance than input is acceptable, as long as the input is at least 1 $\mu$ F.

The input capacitor must be located a distance of not more than 1cm from the input pin and returned to a clean analog ground. Any good quality ceramic, tantalum, or film capacitor can be used at the input.

---

#### 备注

To provide stable operation, good PCB practices must be used to minimize ground impedance and to keep input inductance low. If these conditions cannot be met, or if long leads are used to connect the battery or other power source to the LP5907, increase the input capacitor to at least 10 $\mu$ F. Also, tantalum capacitors can suffer catastrophic failures resulting from surge current when connected to a low-impedance source of power (such as a battery or a very large capacitor). If a tantalum capacitor is used at the input, verify by the manufacturer that the capacitor has a surge current rating sufficient for the application. The initial tolerance, applied voltage derating, and temperature coefficient must all be considered when selecting the input capacitor to make sure that the actual capacitance is never less than 0.7 $\mu$ F over the entire operating range.

---

#### 7.2.2.5 Output Capacitor

The LP5907 is designed specifically to work with a very small ceramic output capacitor, typically 1 $\mu$ F. A ceramic capacitor (dielectric types X5R or X7R) in the 1 $\mu$ F to 10 $\mu$ F range, and with ESR between 5m $\Omega$  to 500m $\Omega$ , is suitable in the LP5907 application circuit. For this device, connect the output capacitor between the OUT pin with a good connection back to the GND pin.

Tantalum or film capacitors can also be used at the device output,  $V_{OUT}$ , but these are not as attractive for reasons of size and cost (see the [Capacitor Characteristics](#) section).

The output capacitor must meet the requirement for the minimum value of capacitance and have an ESR value that is within the range of 5m $\Omega$  to 500m $\Omega$  for stability. Like the input capacitor, the initial tolerance, applied voltage derating, and temperature coefficient must all be considered when selecting the input capacitor to make sure that the actual capacitance is never less than 0.7 $\mu$ F over the entire operating range.

#### 7.2.2.6 Capacitor Characteristics

The LP5907 is designed to work with ceramic capacitors on the input and output to take advantage of the benefits these components offer. For capacitance values in the range of 1 $\mu$ F to 10 $\mu$ F, ceramic capacitors are the smallest, least expensive and have the lowest ESR values, thus making them best for eliminating high-frequency noise. The ESR of a typical 1 $\mu$ F ceramic capacitor is in the range of 20m $\Omega$  to 40m $\Omega$ , which easily meets the ESR requirement for stability for the LP5907.

A better choice for temperature coefficient in a ceramic capacitor is X7R. This type of capacitor is the most stable and holds the capacitance within  $\pm 15\%$  over the temperature range. Tantalum capacitors are less desirable than ceramic for use as output capacitors because they are more expensive when comparing equivalent capacitance and voltage ratings in the 1 $\mu$ F to 10 $\mu$ F range.

Another important consideration is that tantalum capacitors have higher ESR values than equivalent size ceramics. Which means that although a tantalum capacitor can possibly be found with an ESR value within the stable range, the capacitor must be larger in capacitance (which means bigger and more costly) than a ceramic capacitor with the same ESR value. The ESR of a typical tantalum increases by approximately 2:1 when the temperature goes from 25°C down to -40°C, so some guard band must be allowed.

### 7.2.2.7 Remote Capacitor Operation

The LP5907 requires at least a 1 $\mu$ F capacitor at the OUT pin, but there are no strict requirements about the location of the capacitor in regards to the pin. In practical designs the output capacitor can be located up to 10cm away from the LDO. Which means that there is no need to have a special capacitor close to the output pin if there is already respective capacitors in the system (such as a capacitor at the input of supplied device). The remote capacitor feature helps minimize the number of capacitors in the system.

In general, keep the wiring parasitic inductance at a minimum, which means use traces as wide as possible from the LDO output to the capacitors, thus keeping the LDO output trace layer as close to ground layer as possible and avoiding vias on the path. If vias must be used, use as many vias as possible between the connection layers. Keep parasitic wiring inductance less than 35nH. For applications with fast load transients, use an input capacitor equal to or larger to the sum of the capacitance at the output node for best load transient performance.

### 7.2.2.8 No-Load Stability

The LP5907 remains stable, and in regulation, with no external load.

### 7.2.2.9 Enable Control

The LP5907 can be switched on or off by a logic input at the EN pin. A voltage on this pin greater than  $V_{IH}$  turns the device on, and a voltage less than  $V_{IL}$  turns the device off.

When the EN pin is low, the regulator output is off and the device typically consumes less than 1  $\mu$  A. Additionally, an output pulldown circuit is activated that makes sure any charge stored on  $C_{OUT}$  is discharged to ground.

If the application does not require the shutdown feature, the EN pin can be tied directly to the IN pin to keep the regulator output permanently on.

An internal 1M $\Omega$  pulldown resistor ties the EN input to ground, making sure the device remains off if the EN pin is left open circuit. To provide proper operation, the signal source used to drive the EN pin must be able to swing above and below the specified turn-on or turn-off voltage thresholds listed in the [Electrical Characteristics](#) under  $V_{IL}$  and  $V_{IH}$ .

## 7.2.3 Application Curves

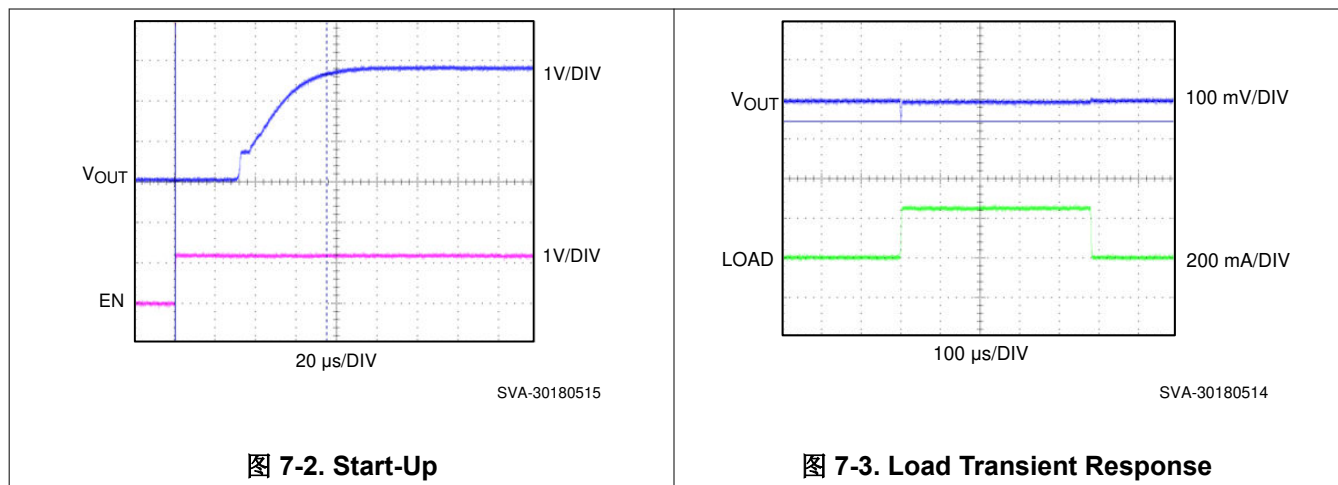

## 7.3 Power Supply Recommendations

This device is designed to operate from an input supply voltage range of 2.2V to 5.5V. The input supply must be well regulated and free of spurious noise. To make sure that the LP5907 output voltage is well regulated and dynamic performance is optimum, the input supply must be at least  $V_{OUT} + 1V$ . A minimum capacitor value of 1 $\mu$ F is required to be within 1cm of the IN pin.



## 7.4 Layout

### 7.4.1 Layout Guidelines

The dynamic performance of the LP5907 is dependent on the layout of the PCB. PCB layout practices that are adequate for typical LDOs can degrade the PSRR, noise, or transient performance of the LP5907.

Best performance is achieved by placing  $C_{IN}$  and  $C_{OUT}$  on the same side of the PCB as the LP5907, and as close to the package as practical. The ground connections for  $C_{IN}$  and  $C_{OUT}$  must route back to the LP5907 ground pin using as wide and short of a copper trace as practical.

Connections using long trace lengths, narrow trace widths, and connections through vias must be avoided. These connections add parasitic inductances and resistance that results in inferior performance, especially during transient conditions.

#### 7.4.1.1 X2SON Mounting

The X2SON package thermal pad must be soldered to the printed circuit board for proper thermal and mechanical performance. For more information, see the [QFN/SON PCB Attachment application note](#).

#### 7.4.1.2 DSBGA Mounting

The DSBGA package requires specific mounting techniques, which are detailed in [AN-1112 DSBGA Wafer Level Chip Scale Package application note](#). For best results during assembly, alignment ordinals on the PC board can be used to facilitate placement of the DSBGA device.

#### 7.4.1.3 DSBGA Light Sensitivity

Exposing the DSBGA device to direct light can cause incorrect operation of the device. Light sources such as halogen lamps can affect electrical performance if these sources are situated in proximity to the device. Light with wavelengths in the red and infrared part of the spectrum have the most detrimental effect; thus, the fluorescent lighting used inside most buildings has very little effect on performance.

### 7.4.2 Layout Examples



图 7-4. SOT-23 Typical Layout



图 7-5. X2SON Typical Layout

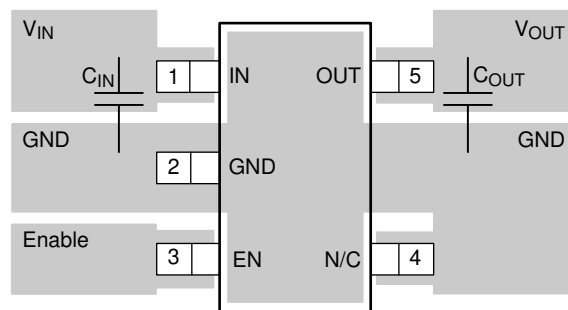

图 7-6. DSBGA Typical Layout

## 8 Device and Documentation Support

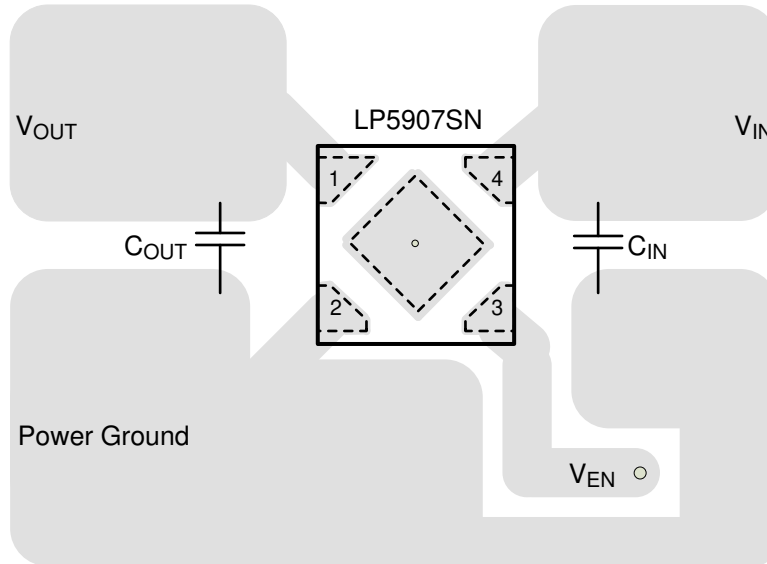
### 8.1 Documentation Support

#### 8.1.1 Custom Design With WEBENCH® Tools

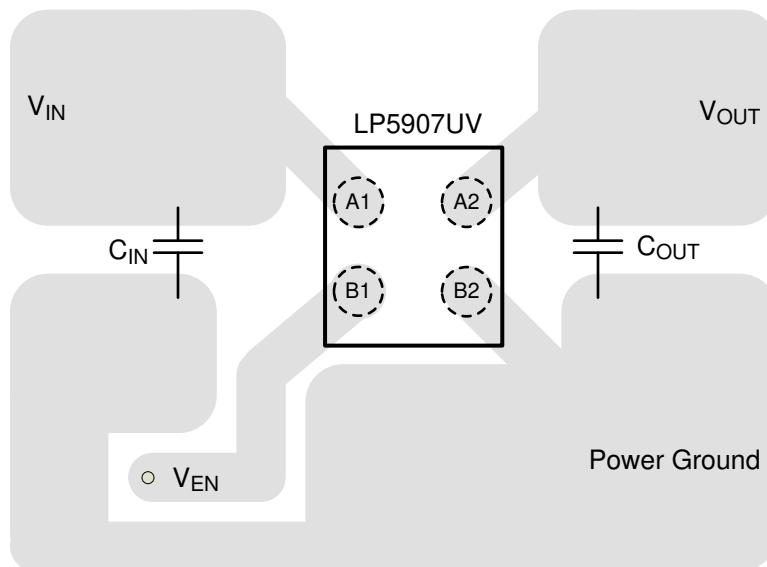
[Click here](#) to create a custom design using the LP5907 device with the WEBENCH® Power Designer.

1. Start by entering the input voltage ( $V_{IN}$ ), output voltage ( $V_{OUT}$ ), and output current ( $I_{OUT}$ ) requirements.
2. Optimize the design for key parameters such as efficiency, footprint, and cost using the optimizer dial.
3. Compare the generated design with other possible solutions from Texas Instruments.

The WEBENCH Power Designer provides a customized schematic along with a list of materials with real-time pricing and component availability.

In most cases, these actions are available:

- Run electrical simulations to see important waveforms and circuit performance
- Run thermal simulations to understand board thermal performance
- Export customized schematic and layout into popular CAD formats
- Print PDF reports for the design, and share the design with colleagues

Get more information about WEBENCH tools at [www.ti.com/WEBENCH](http://www.ti.com/WEBENCH).

#### 8.1.2 Related Documentation

For related documentation, see the following:

- Texas Instruments, [AN-1112 DSBGA Wafer Level Chip Scale Package application note](#)
- Texas Instruments, [QFN/SON PCB Attachment application note](#)

### 8.2 接收文档更新通知

要接收文档更新通知，请导航至 [ti.com](http://ti.com) 上的器件产品文件夹。点击 [通知](#) 进行注册，即可每周接收产品信息更改摘要。有关更改的详细信息，请查看任何已修订文档中包含的修订历史记录。

### 8.3 支持资源

[TI E2E™ 中文支持论坛](#) 是工程师的重要参考资料，可直接从专家处获得快速、经过验证的解答和设计帮助。搜索现有解答或提出自己的问题，获得所需的快速设计帮助。

链接的内容由各个贡献者“按原样”提供。这些内容并不构成 TI 技术规范，并且不一定反映 TI 的观点；请参阅 TI 的 [使用条款](#)。

### 8.4 Trademarks

TI E2E™ is a trademark of Texas Instruments.

WEBENCH® is a registered trademark of Texas Instruments.

所有商标均为其各自所有者的财产。

### 8.5 静电放电警告



静电放电 (ESD) 会损坏这个集成电路。德州仪器 (TI) 建议通过适当的预防措施处理所有集成电路。如果不遵守正确的处理和安装程序，可能会损坏集成电路。

ESD 的损坏小至导致微小的性能降级，大至整个器件故障。精密的集成电路可能更容易受到损坏，这是因为非常细微的参数更改都可能会导致器件与其发布的规格不相符。

### 8.6 术语表

[TI 术语表](#) 本术语表列出并解释了术语、首字母缩略词和定义。

## 9 Revision History

注：以前版本的页码可能与当前版本的页码不同

<b>Changes from Revision O (June 2020) to Revision P (January 2024)</b>	<b>Page</b>
• 更新了整个文档中的表格、图和交叉参考的编号格式.....	1
• Added YCR to pinout caption of <i>Pin Configuration and Functions</i> section.....	3
• Added YCR column to <i>Thermal Information</i> table.....	5

<b>Changes from Revision N (April 2018) to Revision O (June 2020)</b>	<b>Page</b>
• 更改了 <i>应用部分</i> .....	1
• 更改了 <i>器件信息</i> 表中的 DSBGA 封装尺寸.....	1
• Added YKG to pinout caption of <i>Pin Configuration and Functions</i> section.....	3
• Added YKG column to <i>Thermal Information</i> table.....	5

## 10 Mechanical, Packaging, and Orderable Information

The following pages include mechanical, packaging, and orderable information. This information is the most current data available for the designated devices. This data is subject to change without notice and revision of this document. For browser-based versions of this data sheet, refer to the left-hand navigation.

**PACKAGING INFORMATION**

Orderable part number	Status (1)	Material type (2)	Package   Pins	Package qty   Carrier	RoHS (3)	Lead finish/ Ball material (4)	MSL rating/ Peak reflow (5)	Op temp (°C)	Part marking (6)
<a href="#">LP5907A28YKMR</a>	Active	Production	DSBGA (YKM)   4	3000   LARGE T&R	Yes	SAC396	Level-1-260C-UNLIM	-40 to 125	Q
<a href="#">LP5907A33YKMR</a>	Active	Production	DSBGA (YKM)   4	3000   LARGE T&R	Yes	SAC396	Level-1-260C-UNLIM	-40 to 125	N
<a href="#">LP5907MFX-1.2/NOPB</a>	Active	Production	SOT-23 (DBV)   5	3000   LARGE T&R	Yes	NIPDAU   SN	Level-1-260C-UNLIM	-40 to 125	LLTB
<a href="#">LP5907MFX-1.5/NOPB</a>	Active	Production	SOT-23 (DBV)   5	3000   LARGE T&R	Yes	NIPDAU   SN	Level-1-260C-UNLIM	-40 to 125	LN8B
<a href="#">LP5907MFX-1.8/NOPB</a>	Active	Production	SOT-23 (DBV)   5	3000   LARGE T&R	Yes	NIPDAU   SN	Level-1-260C-UNLIM	-40 to 125	LLUB
<a href="#">LP5907MFX-2.5/NOPB</a>	Active	Production	SOT-23 (DBV)   5	3000   LARGE T&R	Yes	NIPDAU   SN	Level-1-260C-UNLIM	-40 to 125	LN7B
<a href="#">LP5907MFX-2.8/NOPB</a>	Active	Production	SOT-23 (DBV)   5	3000   LARGE T&R	Yes	NIPDAU   SN	Level-1-260C-UNLIM	-40 to 125	LLYB
<a href="#">LP5907MFX-2.9/NOPB</a>	Active	Production	SOT-23 (DBV)   5	3000   LARGE T&R	Yes	NIPDAU   SN	Level-1-260C-UNLIM	-40 to 125	1E5X
<a href="#">LP5907MFX-3.0/NOPB</a>	Active	Production	SOT-23 (DBV)   5	3000   LARGE T&R	Yes	NIPDAU   SN	Level-1-260C-UNLIM	-40 to 125	LLZB
<a href="#">LP5907MFX-3.1/NOPB</a>	Active	Production	SOT-23 (DBV)   5	3000   LARGE T&R	Yes	NIPDAU   SN	Level-1-260C-UNLIM	-40 to 125	LN5B
<a href="#">LP5907MFX-3.2/NOPB</a>	Active	Production	SOT-23 (DBV)   5	3000   LARGE T&R	Yes	NIPDAU   SN	Level-1-260C-UNLIM	-40 to 125	LN6B
<a href="#">LP5907MFX-3.3/NOPB</a>	Active	Production	SOT-23 (DBV)   5	3000   LARGE T&R	Yes	NIPDAU   SN	Level-1-260C-UNLIM	-40 to 125	LLVB
<a href="#">LP5907MFX-4.5/NOPB</a>	Active	Production	SOT-23 (DBV)   5	3000   LARGE T&R	Yes	NIPDAU   SN	Level-1-260C-UNLIM	-40 to 125	LLXB
<a href="#">LP5907SNX-1.2/NOPB</a>	Active	Production	X2SON (DQN)   4	3000   LARGE T&R	Yes	NIPDAU   NIPDAU	Level-1-260C-UNLIM	-40 to 125	CF
<a href="#">LP5907SNX-1.8/NOPB</a>	Active	Production	X2SON (DQN)   4	3000   LARGE T&R	Yes	NIPDAU   NIPDAU	Level-1-260C-UNLIM	-40 to 125	CG
<a href="#">LP5907SNX-1.9</a>	Active	Production	X2SON (DQN)   4	3000   LARGE T&R	Yes	NIPDAU   NIPDAU	Level-1-260C-UNLIM	-40 to 125	3Z
<a href="#">LP5907SNX-2.2/NOPB</a>	Active	Production	X2SON (DQN)   4	3000   LARGE T&R	Yes	NIPDAU   NIPDAU	Level-1-260C-UNLIM	-40 to 125	EP
<a href="#">LP5907SNX-2.5/NOPB</a>	Active	Production	X2SON (DQN)   4	3000   LARGE T&R	Yes	NIPDAU   NIPDAU	Level-1-260C-UNLIM	-40 to 125	F9
<a href="#">LP5907SNX-2.7/NOPB</a>	Active	Production	X2SON (DQN)   4	3000   LARGE T&R	Yes	NIPDAU   NIPDAU	Level-1-260C-UNLIM	-40 to 125	CH
<a href="#">LP5907SNX-2.75</a>	Active	Production	X2SON (DQN)   4	3000   LARGE T&R	Yes	NIPDAU   NIPDAU	Level-1-260C-UNLIM	-40 to 125	HI
<a href="#">LP5907SNX-2.8/NOPB</a>	Active	Production	X2SON (DQN)   4	3000   LARGE T&R	Yes	NIPDAU   NIPDAU	Level-1-260C-UNLIM	-40 to 125	CI
<a href="#">LP5907SNX-2.9/NOPB</a>	Active	Production	X2SON (DQN)   4	3000   LARGE T&R	Yes	NIPDAU   NIPDAU	Level-1-260C-UNLIM	-40 to 125	GV
<a href="#">LP5907SNX-3.0/NOPB</a>	Active	Production	X2SON (DQN)   4	3000   LARGE T&R	Yes	NIPDAU   NIPDAU	Level-1-260C-UNLIM	-40 to 125	CK
<a href="#">LP5907SNX-3.1/NOPB</a>	Active	Production	X2SON (DQN)   4	3000   LARGE T&R	Yes	NIPDAU   NIPDAU	Level-1-260C-UNLIM	-40 to 125	CL
<a href="#">LP5907SNX-3.2/NOPB</a>	Active	Production	X2SON (DQN)   4	3000   LARGE T&R	Yes	NIPDAU   NIPDAU	Level-1-260C-UNLIM	-40 to 125	CM
<a href="#">LP5907SNX-3.3/NOPB</a>	Active	Production	X2SON (DQN)   4	3000   LARGE T&R	Yes	NIPDAU   NIPDAU	Level-1-260C-UNLIM	-40 to 125	CN
<a href="#">LP5907SNX-4.0/NOPB</a>	Active	Production	X2SON (DQN)   4	3000   LARGE T&R	Yes	NIPDAU   NIPDAU	Level-1-260C-UNLIM	-40 to 125	GU
<a href="#">LP5907SNX-4.5/NOPB</a>	Active	Production	X2SON (DQN)   4	3000   LARGE T&R	Yes	NIPDAU   NIPDAU	Level-1-260C-UNLIM	-40 to 125	CO
<a href="#">LP5907UVE-1.2/NOPB</a>	Active	Production	DSBGA (YKE)   4	250   SMALL T&R	Yes	SNAGCU	Level-1-260C-UNLIM	-40 to 125	R

Orderable part number	Status (1)	Material type (2)	Package   Pins	Package qty   Carrier	RoHS (3)	Lead finish/ Ball material (4)	MSL rating/ Peak reflow (5)	Op temp (°C)	Part marking (6)
<a href="#">LP5907UVE-1.8/NOPB</a>	Active	Production	DSBGA (YKE)   4	250   SMALL T&R	Yes	SNAGCU	Level-1-260C-UNLIM	-40 to 125	S
<a href="#">LP5907UVE-2.8/NOPB</a>	Active	Production	DSBGA (YKE)   4	250   SMALL T&R	Yes	SNAGCU	Level-1-260C-UNLIM	-40 to 125	U
<a href="#">LP5907UVE-3.0/NOPB</a>	Active	Production	DSBGA (YKE)   4	250   SMALL T&R	Yes	SNAGCU	Level-1-260C-UNLIM	-40 to 125	B
<a href="#">LP5907UVE-3.1/NOPB</a>	Active	Production	DSBGA (YKE)   4	250   SMALL T&R	Yes	SNAGCU	Level-1-260C-UNLIM	-40 to 125	X
<a href="#">LP5907UVE-3.2/NOPB</a>	Active	Production	DSBGA (YKE)   4	250   SMALL T&R	Yes	SNAGCU	Level-1-260C-UNLIM	-40 to 125	C
<a href="#">LP5907UVE-3.3/NOPB</a>	Active	Production	DSBGA (YKE)   4	250   SMALL T&R	Yes	SNAGCU	Level-1-260C-UNLIM	-40 to 125	D
<a href="#">LP5907UVE-4.5/NOPB</a>	Active	Production	DSBGA (YKE)   4	250   SMALL T&R	Yes	SNAGCU	Level-1-260C-UNLIM	-40 to 125	Z
<a href="#">LP5907UVX-1.2/NOPB</a>	Active	Production	DSBGA (YKE)   4	3000   LARGE T&R	Yes	SNAGCU	Level-1-260C-UNLIM	-40 to 125	R
<a href="#">LP5907UVX-1.8/NOPB</a>	Active	Production	DSBGA (YKE)   4	3000   LARGE T&R	Yes	SNAGCU	Level-1-260C-UNLIM	-40 to 125	S
<a href="#">LP5907UVX-2.5/NOPB</a>	Active	Production	DSBGA (YKE)   4	3000   LARGE T&R	Yes	SNAGCU	Level-1-260C-UNLIM	-40 to 125	E
<a href="#">LP5907UVX-2.8/NOPB</a>	Active	Production	DSBGA (YKE)   4	3000   LARGE T&R	Yes	SNAGCU	Level-1-260C-UNLIM	-40 to 125	U
<a href="#">LP5907UVX-3.0/NOPB</a>	Active	Production	DSBGA (YKE)   4	3000   LARGE T&R	Yes	SNAGCU	Level-1-260C-UNLIM	-40 to 125	B
<a href="#">LP5907UVX-3.1/NOPB</a>	Active	Production	DSBGA (YKE)   4	3000   LARGE T&R	Yes	SNAGCU	Level-1-260C-UNLIM	-40 to 125	X
<a href="#">LP5907UVX-3.2/NOPB</a>	Active	Production	DSBGA (YKE)   4	3000   LARGE T&R	Yes	SNAGCU	Level-1-260C-UNLIM	-40 to 125	C
<a href="#">LP5907UVX-3.3/NOPB</a>	Active	Production	DSBGA (YKE)   4	3000   LARGE T&R	Yes	SAC396   SNAGCU	Level-1-260C-UNLIM	-40 to 125	D
<a href="#">LP5907UVX-4.5/NOPB</a>	Active	Production	DSBGA (YKE)   4	3000   LARGE T&R	Yes	SNAGCU	Level-1-260C-UNLIM	-40 to 125	Z
<a href="#">LP5907UVX19/NOPB</a>	Active	Production	DSBGA (YKE)   4	3000   LARGE T&R	Yes	SNAGCU	Level-1-260C-UNLIM	-40 to 125	8
<a href="#">LP5907UVX37/NOPB</a>	Active	Production	DSBGA (YKE)   4	3000   LARGE T&R	Yes	SNAGCU	Level-1-260C-UNLIM	-40 to 125	9
<a href="#">LP5907YKGR-2.8</a>	Active	Production	DSBGA (YKG)   4	3000   LARGE T&R	Yes	SAC396	Level-1-260C-UNLIM	-40 to 125	3
<a href="#">LP5907YKGR-2.825</a>	Active	Production	DSBGA (YKG)   4	3000   LARGE T&R	Yes	SAC396	Level-1-260C-UNLIM	-40 to 125	5
<a href="#">LP5907YKGR-2.85</a>	Active	Production	DSBGA (YKG)   4	3000   LARGE T&R	Yes	SAC396	Level-1-260C-UNLIM	-40 to 125	P

(1) **Status:** For more details on status, see our [product life cycle](#).

(2) **Material type:** When designated, preproduction parts are prototypes/experimental devices, and are not yet approved or released for full production. Testing and final process, including without limitation quality assurance, reliability performance testing, and/or process qualification, may not yet be complete, and this item is subject to further changes or possible discontinuation. If available for ordering, purchases will be subject to an additional waiver at checkout, and are intended for early internal evaluation purposes only. These items are sold without warranties of any kind.

(3) **RoHS values:** Yes, No, RoHS Exempt. See the [TI RoHS Statement](#) for additional information and value definition.

(4) **Lead finish/Ball material:** Parts may have multiple material finish options. Finish options are separated by a vertical ruled line. Lead finish/Ball material values may wrap to two lines if the finish value exceeds the maximum column width.

<sup>(5)</sup> **MSL rating/Peak reflow:** The moisture sensitivity level ratings and peak solder (reflow) temperatures. In the event that a part has multiple moisture sensitivity ratings, only the lowest level per JEDEC standards is shown. Refer to the shipping label for the actual reflow temperature that will be used to mount the part to the printed circuit board.

<sup>(6)</sup> **Part marking:** There may be an additional marking, which relates to the logo, the lot trace code information, or the environmental category of the part.

Multiple part markings will be inside parentheses. Only one part marking contained in parentheses and separated by a "~" will appear on a part. If a line is indented then it is a continuation of the previous line and the two combined represent the entire part marking for that device.

**Important Information and Disclaimer:**The information provided on this page represents TI's knowledge and belief as of the date that it is provided. TI bases its knowledge and belief on information provided by third parties, and makes no representation or warranty as to the accuracy of such information. Efforts are underway to better integrate information from third parties. TI has taken and continues to take reasonable steps to provide representative and accurate information but may not have conducted destructive testing or chemical analysis on incoming materials and chemicals. TI and TI suppliers consider certain information to be proprietary, and thus CAS numbers and other limited information may not be available for release.

In no event shall TI's liability arising out of such information exceed the total purchase price of the TI part(s) at issue in this document sold by TI to Customer on an annual basis.

**OTHER QUALIFIED VERSIONS OF LP5907 :**

- Automotive : [LP5907-Q1](#)

NOTE: Qualified Version Definitions:

- Automotive - Q100 devices qualified for high-reliability automotive applications targeting zero defects

**TAPE AND REEL INFORMATION**

**QUADRANT ASSIGNMENTS FOR PIN 1 ORIENTATION IN TAPE**

\*All dimensions are nominal

Device	Package Type	Package Drawing	Pins	SPQ	Reel Diameter (mm)	Reel Width W1 (mm)	A0 (mm)	B0 (mm)	K0 (mm)	P1 (mm)	W (mm)	Pin1 Quadrant
LP5907A28YKMR	DSBGA	YKM	4	3000	178.0	8.4	0.74	0.74	0.54	4.0	8.0	Q1
LP5907A33YKMR	DSBGA	YKM	4	3000	178.0	8.4	0.74	0.74	0.54	4.0	8.0	Q1
LP5907MFX-1.2/NOPB	SOT-23	DBV	5	3000	180.0	8.4	3.2	3.2	1.4	4.0	8.0	Q3
LP5907MFX-1.2/NOPB	SOT-23	DBV	5	3000	180.0	8.4	3.2	3.2	1.4	4.0	8.0	Q3
LP5907MFX-1.2/NOPB	SOT-23	DBV	5	3000	178.0	8.4	3.2	3.2	1.4	4.0	8.0	Q3
LP5907MFX-1.5/NOPB	SOT-23	DBV	5	3000	178.0	8.4	3.2	3.2	1.4	4.0	8.0	Q3
LP5907MFX-1.5/NOPB	SOT-23	DBV	5	3000	180.0	8.4	3.2	3.2	1.4	4.0	8.0	Q3
LP5907MFX-1.5/NOPB	SOT-23	DBV	5	3000	180.0	8.4	3.2	3.2	1.4	4.0	8.0	Q3
LP5907MFX-1.8/NOPB	SOT-23	DBV	5	3000	178.0	8.4	3.2	3.2	1.4	4.0	8.0	Q3
LP5907MFX-1.8/NOPB	SOT-23	DBV	5	3000	180.0	8.4	3.2	3.2	1.4	4.0	8.0	Q3
LP5907MFX-1.8/NOPB	SOT-23	DBV	5	3000	180.0	8.4	3.2	3.2	1.4	4.0	8.0	Q3
LP5907MFX-2.5/NOPB	SOT-23	DBV	5	3000	180.0	8.4	3.2	3.2	1.4	4.0	8.0	Q3
LP5907MFX-2.5/NOPB	SOT-23	DBV	5	3000	180.0	8.4	3.2	3.2	1.4	4.0	8.0	Q3
LP5907MFX-2.5/NOPB	SOT-23	DBV	5	3000	178.0	8.4	3.2	3.2	1.4	4.0	8.0	Q3
LP5907MFX-2.8/NOPB	SOT-23	DBV	5	3000	178.0	8.4	3.2	3.2	1.4	4.0	8.0	Q3
LP5907MFX-2.8/NOPB	SOT-23	DBV	5	3000	180.0	8.4	3.2	3.2	1.4	4.0	8.0	Q3



Device	Package Type	Package Drawing	Pins	SPQ	Reel Diameter (mm)	Reel Width W1 (mm)	A0 (mm)	B0 (mm)	K0 (mm)	P1 (mm)	W (mm)	Pin1 Quadrant
LP5907MFX-2.85/NOPB	SOT-23	DBV	5	3000	180.0	8.4	3.2	3.2	1.4	4.0	8.0	Q3
LP5907MFX-2.85/NOPB	SOT-23	DBV	5	3000	180.0	8.4	3.2	3.2	1.4	4.0	8.0	Q3
LP5907MFX-2.85/NOPB	SOT-23	DBV	5	3000	178.0	8.4	3.2	3.2	1.4	4.0	8.0	Q3
LP5907MFX-2.9/NOPB	SOT-23	DBV	5	3000	180.0	8.4	3.2	3.2	1.4	4.0	8.0	Q3
LP5907MFX-2.9/NOPB	SOT-23	DBV	5	3000	180.0	8.4	3.2	3.2	1.4	4.0	8.0	Q3
LP5907MFX-2.9/NOPB	SOT-23	DBV	5	3000	178.0	8.4	3.2	3.2	1.4	4.0	8.0	Q3
LP5907MFX-3.0/NOPB	SOT-23	DBV	5	3000	178.0	8.4	3.2	3.2	1.4	4.0	8.0	Q3
LP5907MFX-3.0/NOPB	SOT-23	DBV	5	3000	180.0	8.4	3.2	3.2	1.4	4.0	8.0	Q3
LP5907MFX-3.0/NOPB	SOT-23	DBV	5	3000	180.0	8.4	3.2	3.2	1.4	4.0	8.0	Q3
LP5907MFX-3.1/NOPB	SOT-23	DBV	5	3000	178.0	8.4	3.2	3.2	1.4	4.0	8.0	Q3
LP5907MFX-3.1/NOPB	SOT-23	DBV	5	3000	180.0	8.4	3.2	3.2	1.4	4.0	8.0	Q3
LP5907MFX-3.1/NOPB	SOT-23	DBV	5	3000	180.0	8.4	3.2	3.2	1.4	4.0	8.0	Q3
LP5907MFX-3.2/NOPB	SOT-23	DBV	5	3000	178.0	8.4	3.2	3.2	1.4	4.0	8.0	Q3
LP5907MFX-3.2/NOPB	SOT-23	DBV	5	3000	180.0	8.4	3.2	3.2	1.4	4.0	8.0	Q3
LP5907MFX-3.2/NOPB	SOT-23	DBV	5	3000	180.0	8.4	3.2	3.2	1.4	4.0	8.0	Q3
LP5907MFX-3.3/NOPB	SOT-23	DBV	5	3000	178.0	8.4	3.2	3.2	1.4	4.0	8.0	Q3
LP5907MFX-3.3/NOPB	SOT-23	DBV	5	3000	180.0	8.4	3.2	3.2	1.4	4.0	8.0	Q3
LP5907MFX-3.3/NOPB	SOT-23	DBV	5	3000	180.0	8.4	3.2	3.2	1.4	4.0	8.0	Q3
LP5907MFX-3.3/NOPB	SOT-23	DBV	5	3000	180.0	8.4	3.2	3.2	1.4	4.0	8.0	Q3
LP5907MFX-4.5/NOPB	SOT-23	DBV	5	3000	180.0	8.4	3.2	3.2	1.4	4.0	8.0	Q3
LP5907MFX-4.5/NOPB	SOT-23	DBV	5	3000	180.0	8.4	3.2	3.2	1.4	4.0	8.0	Q3
LP5907MFX-4.5/NOPB	SOT-23	DBV	5	3000	178.0	8.4	3.2	3.2	1.4	4.0	8.0	Q3
LP5907SNX-1.2/NOPB	X2SON	DQN	4	3000	180.0	8.4	1.16	1.16	0.5	4.0	8.0	Q2
LP5907SNX-1.8/NOPB	X2SON	DQN	4	3000	180.0	8.4	1.16	1.16	0.5	4.0	8.0	Q2
LP5907SNX-1.8/NOPB	X2SON	DQN	4	3000	180.0	9.5	1.16	1.16	0.63	4.0	8.0	Q2
LP5907SNX-1.9	X2SON	DQN	4	3000	180.0	8.4	1.16	1.16	0.5	4.0	8.0	Q2
LP5907SNX-2.2/NOPB	X2SON	DQN	4	3000	180.0	8.4	1.16	1.16	0.5	4.0	8.0	Q2
LP5907SNX-2.5/NOPB	X2SON	DQN	4	3000	180.0	8.4	1.16	1.16	0.5	4.0	8.0	Q2
LP5907SNX-2.7/NOPB	X2SON	DQN	4	3000	180.0	8.4	1.16	1.16	0.5	4.0	8.0	Q2
LP5907SNX-2.75	X2SON	DQN	4	3000	180.0	9.5	1.16	1.16	0.63	4.0	8.0	Q2
LP5907SNX-2.75	X2SON	DQN	4	3000	180.0	8.4	1.16	1.16	0.5	4.0	8.0	Q2
LP5907SNX-2.8/NOPB	X2SON	DQN	4	3000	180.0	8.4	1.16	1.16	0.5	4.0	8.0	Q2
LP5907SNX-2.85/NOPB	X2SON	DQN	4	3000	180.0	8.4	1.16	1.16	0.5	4.0	8.0	Q2
LP5907SNX-2.9/NOPB	X2SON	DQN	4	3000	180.0	8.4	1.16	1.16	0.5	4.0	8.0	Q2
LP5907SNX-3.0/NOPB	X2SON	DQN	4	3000	180.0	9.5	1.16	1.16	0.63	4.0	8.0	Q2
LP5907SNX-3.1/NOPB	X2SON	DQN	4	3000	180.0	8.4	1.16	1.16	0.5	4.0	8.0	Q2
LP5907SNX-3.2/NOPB	X2SON	DQN	4	3000	180.0	8.4	1.16	1.16	0.5	4.0	8.0	Q2
LP5907SNX-3.3/NOPB	X2SON	DQN	4	3000	180.0	9.5	1.16	1.16	0.63	4.0	8.0	Q2
LP5907SNX-3.3/NOPB	X2SON	DQN	4	3000	180.0	8.4	1.16	1.16	0.5	4.0	8.0	Q2
LP5907SNX-4.0/NOPB	X2SON	DQN	4	3000	180.0	8.4	1.16	1.16	0.5	4.0	8.0	Q2
LP5907SNX-4.5/NOPB	X2SON	DQN	4	3000	180.0	8.4	1.16	1.16	0.5	4.0	8.0	Q2
LP5907UVE-1.2/NOPB	DSBGA	YKE	4	250	178.0	8.4	0.71	0.71	0.51	2.0	8.0	Q1

Device	Package Type	Package Drawing	Pins	SPQ	Reel Diameter (mm)	Reel Width W1 (mm)	A0 (mm)	B0 (mm)	K0 (mm)	P1 (mm)	W (mm)	Pin1 Quadrant
LP5907UVE-1.8/NOPB	DSBGA	YKE	4	250	178.0	8.4	0.71	0.71	0.51	2.0	8.0	Q1
LP5907UVE-2.8/NOPB	DSBGA	YKE	4	250	178.0	8.4	0.71	0.71	0.51	2.0	8.0	Q1
LP5907UVE-2.85/NOPB	DSBGA	YKE	4	250	178.0	8.4	0.71	0.71	0.51	2.0	8.0	Q1
LP5907UVE-3.0/NOPB	DSBGA	YKE	4	250	178.0	8.4	0.71	0.71	0.51	2.0	8.0	Q1
LP5907UVE-3.1/NOPB	DSBGA	YKE	4	250	178.0	8.4	0.71	0.71	0.51	2.0	8.0	Q1
LP5907UVE-3.2/NOPB	DSBGA	YKE	4	250	178.0	8.4	0.71	0.71	0.51	2.0	8.0	Q1
LP5907UVE-3.3/NOPB	DSBGA	YKE	4	250	178.0	8.4	0.71	0.71	0.51	2.0	8.0	Q1
LP5907UVE-4.5/NOPB	DSBGA	YKE	4	250	178.0	8.4	0.71	0.71	0.51	2.0	8.0	Q1
LP5907UVX-1.2/NOPB	DSBGA	YKE	4	3000	178.0	8.4	0.71	0.71	0.51	2.0	8.0	Q1
LP5907UVX-1.8/NOPB	DSBGA	YKE	4	3000	178.0	8.4	0.71	0.71	0.51	2.0	8.0	Q1
LP5907UVX-2.5/NOPB	DSBGA	YKE	4	3000	178.0	8.4	0.71	0.71	0.51	2.0	8.0	Q1
LP5907UVX-2.8/NOPB	DSBGA	YKE	4	3000	178.0	8.4	0.71	0.71	0.51	2.0	8.0	Q1
LP5907UVX-2.85/NOPB	DSBGA	YKE	4	3000	178.0	8.4	0.71	0.71	0.51	2.0	8.0	Q1
LP5907UVX-3.0/NOPB	DSBGA	YKE	4	3000	178.0	8.4	0.71	0.71	0.51	2.0	8.0	Q1
LP5907UVX-3.1/NOPB	DSBGA	YKE	4	3000	178.0	8.4	0.71	0.71	0.51	2.0	8.0	Q1
LP5907UVX-3.2/NOPB	DSBGA	YKE	4	3000	178.0	8.4	0.71	0.71	0.51	2.0	8.0	Q1
LP5907UVX-3.3/NOPB	DSBGA	YKE	4	3000	178.0	8.4	0.71	0.71	0.51	2.0	8.0	Q1
LP5907UVX-4.5/NOPB	DSBGA	YKE	4	3000	178.0	8.4	0.71	0.71	0.51	2.0	8.0	Q1
LP5907UVX19/NOPB	DSBGA	YKE	4	3000	178.0	8.4	0.71	0.71	0.51	2.0	8.0	Q1
LP5907UVX37/NOPB	DSBGA	YKE	4	3000	178.0	8.4	0.71	0.71	0.51	2.0	8.0	Q1
LP5907YKGR-2.8	DSBGA	YKG	4	3000	178.0	9.2	0.72	0.72	0.39	4.0	8.0	Q1
LP5907YKGR-2.825	DSBGA	YKG	4	3000	178.0	9.2	0.72	0.72	0.39	4.0	8.0	Q1
LP5907YKGR-2.85	DSBGA	YKG	4	3000	178.0	9.2	0.72	0.72	0.39	4.0	8.0	Q1

**TAPE AND REEL BOX DIMENSIONS**

\*All dimensions are nominal

Device	Package Type	Package Drawing	Pins	SPQ	Length (mm)	Width (mm)	Height (mm)
LP5907A28YKMR	DSBGA	YKM	4	3000	220.0	220.0	35.0
LP5907A33YKMR	DSBGA	YKM	4	3000	220.0	220.0	35.0
LP5907MFX-1.2/NOPB	SOT-23	DBV	5	3000	210.0	185.0	35.0
LP5907MFX-1.2/NOPB	SOT-23	DBV	5	3000	210.0	185.0	35.0
LP5907MFX-1.2/NOPB	SOT-23	DBV	5	3000	208.0	191.0	35.0
LP5907MFX-1.5/NOPB	SOT-23	DBV	5	3000	208.0	191.0	35.0
LP5907MFX-1.5/NOPB	SOT-23	DBV	5	3000	210.0	185.0	35.0
LP5907MFX-1.5/NOPB	SOT-23	DBV	5	3000	210.0	185.0	35.0
LP5907MFX-1.8/NOPB	SOT-23	DBV	5	3000	208.0	191.0	35.0
LP5907MFX-1.8/NOPB	SOT-23	DBV	5	3000	210.0	185.0	35.0
LP5907MFX-1.8/NOPB	SOT-23	DBV	5	3000	210.0	185.0	35.0
LP5907MFX-2.5/NOPB	SOT-23	DBV	5	3000	210.0	185.0	35.0
LP5907MFX-2.5/NOPB	SOT-23	DBV	5	3000	210.0	185.0	35.0
LP5907MFX-2.5/NOPB	SOT-23	DBV	5	3000	208.0	191.0	35.0
LP5907MFX-2.8/NOPB	SOT-23	DBV	5	3000	208.0	191.0	35.0
LP5907MFX-2.8/NOPB	SOT-23	DBV	5	3000	210.0	185.0	35.0
LP5907MFX-2.85/NOPB	SOT-23	DBV	5	3000	210.0	185.0	35.0
LP5907MFX-2.85/NOPB	SOT-23	DBV	5	3000	210.0	185.0	35.0

Device	Package Type	Package Drawing	Pins	SPQ	Length (mm)	Width (mm)	Height (mm)
LP5907MFX-2.85/NOPB	SOT-23	DBV	5	3000	208.0	191.0	35.0
LP5907MFX-2.9/NOPB	SOT-23	DBV	5	3000	210.0	185.0	35.0
LP5907MFX-2.9/NOPB	SOT-23	DBV	5	3000	210.0	185.0	35.0
LP5907MFX-2.9/NOPB	SOT-23	DBV	5	3000	208.0	191.0	35.0
LP5907MFX-3.0/NOPB	SOT-23	DBV	5	3000	208.0	191.0	35.0
LP5907MFX-3.0/NOPB	SOT-23	DBV	5	3000	210.0	185.0	35.0
LP5907MFX-3.0/NOPB	SOT-23	DBV	5	3000	210.0	185.0	35.0
LP5907MFX-3.1/NOPB	SOT-23	DBV	5	3000	208.0	191.0	35.0
LP5907MFX-3.1/NOPB	SOT-23	DBV	5	3000	210.0	185.0	35.0
LP5907MFX-3.1/NOPB	SOT-23	DBV	5	3000	210.0	185.0	35.0
LP5907MFX-3.2/NOPB	SOT-23	DBV	5	3000	208.0	191.0	35.0
LP5907MFX-3.2/NOPB	SOT-23	DBV	5	3000	210.0	185.0	35.0
LP5907MFX-3.2/NOPB	SOT-23	DBV	5	3000	210.0	185.0	35.0
LP5907MFX-3.3/NOPB	SOT-23	DBV	5	3000	208.0	191.0	35.0
LP5907MFX-3.3/NOPB	SOT-23	DBV	5	3000	210.0	185.0	35.0
LP5907MFX-3.3/NOPB	SOT-23	DBV	5	3000	210.0	185.0	35.0
LP5907MFX-4.5/NOPB	SOT-23	DBV	5	3000	210.0	185.0	35.0
LP5907MFX-4.5/NOPB	SOT-23	DBV	5	3000	210.0	185.0	35.0
LP5907MFX-4.5/NOPB	SOT-23	DBV	5	3000	208.0	191.0	35.0
LP5907SNX-1.2/NOPB	X2SON	DQN	4	3000	210.0	185.0	35.0
LP5907SNX-1.8/NOPB	X2SON	DQN	4	3000	210.0	185.0	35.0
LP5907SNX-1.8/NOPB	X2SON	DQN	4	3000	184.0	184.0	19.0
LP5907SNX-1.9	X2SON	DQN	4	3000	210.0	185.0	35.0
LP5907SNX-2.2/NOPB	X2SON	DQN	4	3000	210.0	185.0	35.0
LP5907SNX-2.5/NOPB	X2SON	DQN	4	3000	210.0	185.0	35.0
LP5907SNX-2.7/NOPB	X2SON	DQN	4	3000	210.0	185.0	35.0
LP5907SNX-2.75	X2SON	DQN	4	3000	184.0	184.0	19.0
LP5907SNX-2.75	X2SON	DQN	4	3000	210.0	185.0	35.0
LP5907SNX-2.8/NOPB	X2SON	DQN	4	3000	210.0	185.0	35.0
LP5907SNX-2.85/NOPB	X2SON	DQN	4	3000	210.0	185.0	35.0
LP5907SNX-2.9/NOPB	X2SON	DQN	4	3000	210.0	185.0	35.0
LP5907SNX-3.0/NOPB	X2SON	DQN	4	3000	184.0	184.0	19.0
LP5907SNX-3.1/NOPB	X2SON	DQN	4	3000	210.0	185.0	35.0
LP5907SNX-3.2/NOPB	X2SON	DQN	4	3000	210.0	185.0	35.0
LP5907SNX-3.3/NOPB	X2SON	DQN	4	3000	184.0	184.0	19.0
LP5907SNX-3.3/NOPB	X2SON	DQN	4	3000	210.0	185.0	35.0
LP5907SNX-4.0/NOPB	X2SON	DQN	4	3000	210.0	185.0	35.0
LP5907SNX-4.5/NOPB	X2SON	DQN	4	3000	210.0	185.0	35.0
LP5907UVE-1.2/NOPB	DSBGA	YKE	4	250	208.0	191.0	35.0
LP5907UVE-1.8/NOPB	DSBGA	YKE	4	250	208.0	191.0	35.0
LP5907UVE-2.8/NOPB	DSBGA	YKE	4	250	208.0	191.0	35.0
LP5907UVE-2.85/NOPB	DSBGA	YKE	4	250	208.0	191.0	35.0
LP5907UVE-3.0/NOPB	DSBGA	YKE	4	250	208.0	191.0	35.0

Device	Package Type	Package Drawing	Pins	SPQ	Length (mm)	Width (mm)	Height (mm)
LP5907UVE-3.1/NOPB	DSBGA	YKE	4	250	208.0	191.0	35.0
LP5907UVE-3.2/NOPB	DSBGA	YKE	4	250	208.0	191.0	35.0
LP5907UVE-3.3/NOPB	DSBGA	YKE	4	250	208.0	191.0	35.0
LP5907UVE-4.5/NOPB	DSBGA	YKE	4	250	208.0	191.0	35.0
LP5907UVX-1.2/NOPB	DSBGA	YKE	4	3000	208.0	191.0	35.0
LP5907UVX-1.8/NOPB	DSBGA	YKE	4	3000	208.0	191.0	35.0
LP5907UVX-2.5/NOPB	DSBGA	YKE	4	3000	208.0	191.0	35.0
LP5907UVX-2.8/NOPB	DSBGA	YKE	4	3000	208.0	191.0	35.0
LP5907UVX-2.85/NOPB	DSBGA	YKE	4	3000	208.0	191.0	35.0
LP5907UVX-3.0/NOPB	DSBGA	YKE	4	3000	208.0	191.0	35.0
LP5907UVX-3.1/NOPB	DSBGA	YKE	4	3000	208.0	191.0	35.0
LP5907UVX-3.2/NOPB	DSBGA	YKE	4	3000	208.0	191.0	35.0
LP5907UVX-3.3/NOPB	DSBGA	YKE	4	3000	208.0	191.0	35.0
LP5907UVX-4.5/NOPB	DSBGA	YKE	4	3000	208.0	191.0	35.0
LP5907UVX19/NOPB	DSBGA	YKE	4	3000	208.0	191.0	35.0
LP5907UVX37/NOPB	DSBGA	YKE	4	3000	208.0	191.0	35.0
LP5907YKGR-2.8	DSBGA	YKG	4	3000	220.0	220.0	35.0
LP5907YKGR-2.825	DSBGA	YKG	4	3000	220.0	220.0	35.0
LP5907YKGR-2.85	DSBGA	YKG	4	3000	220.0	220.0	35.0



# EXAMPLE BOARD LAYOUT

DBV0005A

SOT-23 - 1.45 mm max height

SMALL OUTLINE TRANSISTOR



LAND PATTERN EXAMPLE  
EXPOSED METAL SHOWN  
SCALE:15X



SOLDER MASK DETAILS

4214839/K 08/2024

NOTES: (continued)

- 6. Publication IPC-7351 may have alternate designs.
- 7. Solder mask tolerances between and around signal pads can vary based on board fabrication site.

# EXAMPLE STENCIL DESIGN

DBV0005A

SOT-23 - 1.45 mm max height

SMALL OUTLINE TRANSISTOR



SOLDER PASTE EXAMPLE  
BASED ON 0.125 mm THICK STENCIL  
SCALE:15X

4214839/K 08/2024

NOTES: (continued)

8. Laser cutting apertures with trapezoidal walls and rounded corners may offer better paste release. IPC-7525 may have alternate design recommendations.
9. Board assembly site may have different recommendations for stencil design.





# EXAMPLE BOARD LAYOUT

YKG0004

DSBGA - 0.33mm MAX HEIGHT

DIE SIZE BALL GRID ARRAY

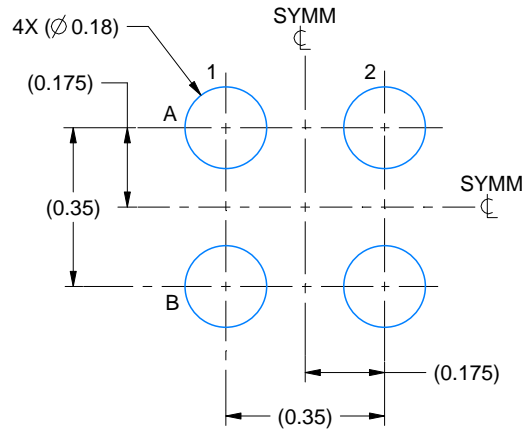

LAND PATTERN EXAMPLE  
EXPOSED METAL SHOWN  
SCALE:60X

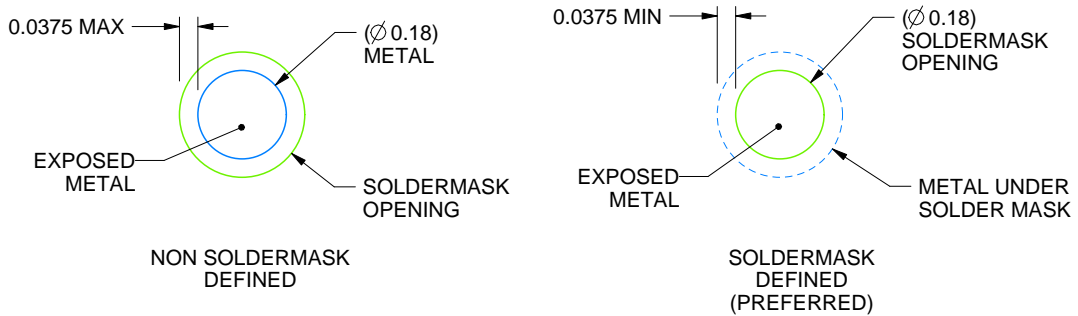

SOLDERMASK DETAILS  
NOT TO SCALE

4218366/E 05/2020

NOTES: (continued)

- Final dimensions may vary due to manufacturing tolerance considerations and also routing constraints. Refer to Texas Instruments Literature No. SNVA009 ([www.ti.com/lit/snva009](http://www.ti.com/lit/snva009)).

# EXAMPLE STENCIL DESIGN

YKG0004

DSBGA - 0.33mm MAX HEIGHT

DIE SIZE BALL GRID ARRAY

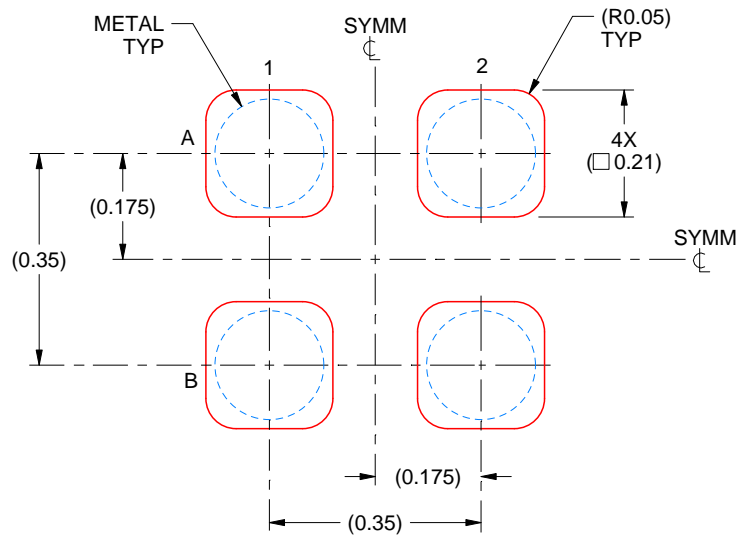

SOLDERPASTE EXAMPLE  
BASED ON 0.075 mm THICK STENCIL  
SCALE:80X

4218366/E 05/2020

NOTES: (continued)

4. Laser cutting apertures with trapezoidal walls and rounded corners may offer better paste release.



YKM0004

# PACKAGE OUTLINE

DSBGA - 0.495 mm max height

DIE SIZE BALL GRID ARRAY

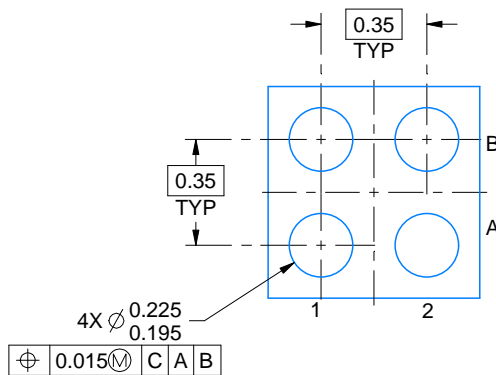
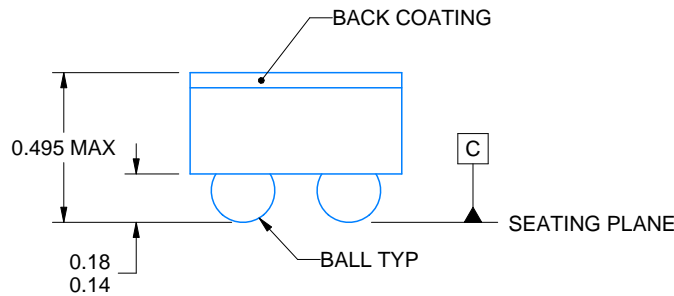
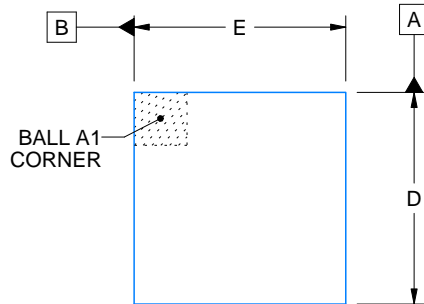

D: Max = 0.675 mm, Min = 0.615 mm  
 E: Max = 0.675 mm, Min = 0.615 mm

4223494/A 11/2014

NOTES:

1. All linear dimensions are in millimeters. Any dimensions in parenthesis are for reference only. Dimensioning and tolerancing per ASME Y14.5M.
2. This drawing is subject to change without notice.

# EXAMPLE BOARD LAYOUT

YKM0004

DSBGA - 0.495 mm max height

DIE SIZE BALL GRID ARRAY

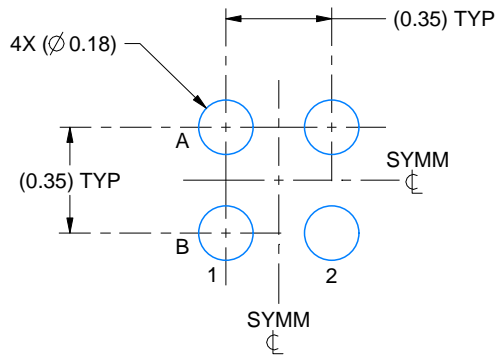

LAND PATTERN EXAMPLE  
EXPOSED METAL SHOWN  
SCALE:40X

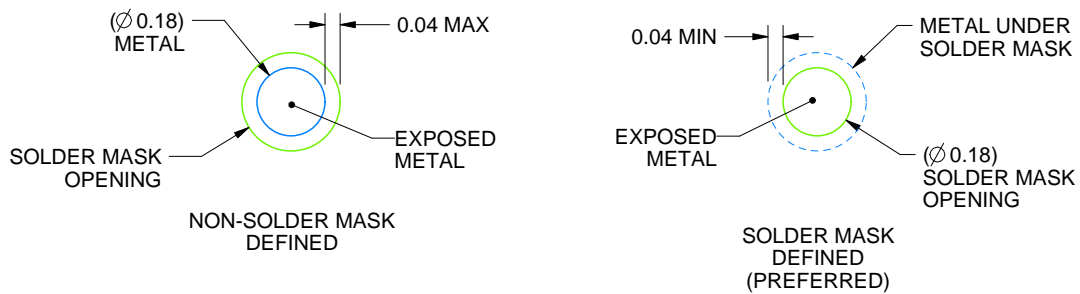

SOLDER MASK DETAILS  
NOT TO SCALE

4223494/A 11/2014

NOTES: (continued)

- Final dimensions may vary due to manufacturing tolerance considerations and also routing constraints. Refer to Texas Instruments Literature No. SNVA009 ([www.ti.com/lit/snva009](http://www.ti.com/lit/snva009)).

# EXAMPLE STENCIL DESIGN

YKM0004

DSBGA - 0.495 mm max height

DIE SIZE BALL GRID ARRAY

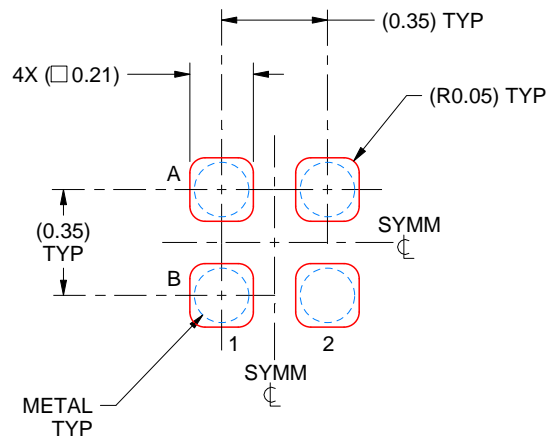

SOLDER PASTE EXAMPLE  
BASED ON 0.075 - 0.1mm THICK STENCIL  
SCALE:40X

4223494/A 11/2014

NOTES: (continued)

4. Laser cutting apertures with trapezoidal walls and rounded corners may offer better paste release.



YKE0004

# PACKAGE OUTLINE

DSBGA - 0.445mm max height

DIE SIZE BALL GRID ARRAY

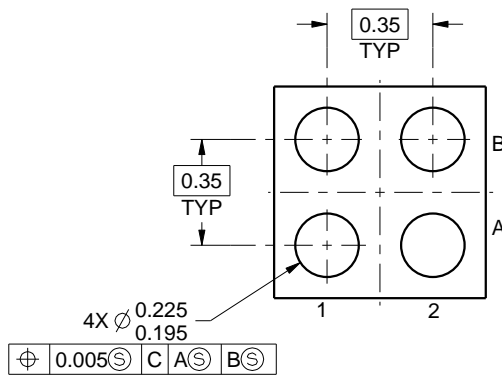
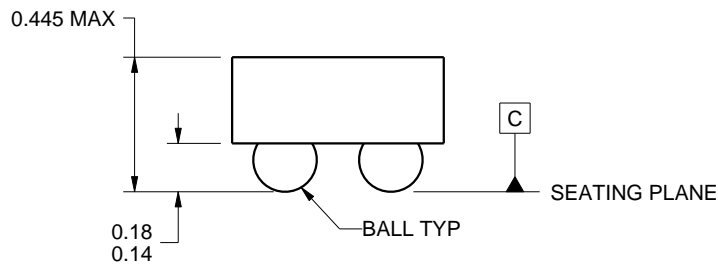
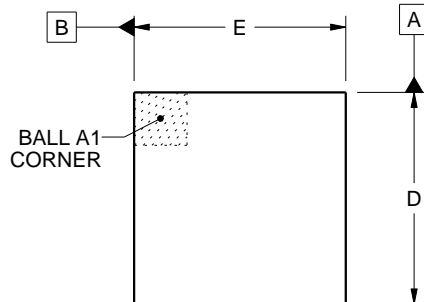

D: Max = 0.675 mm, Min = 0.615 mm
E: Max = 0.675 mm, Min = 0.615 mm

4220102/A 11/2014

NOTES:

1. All linear dimensions are in millimeters. Any dimensions in parenthesis are for reference only. Dimensioning and tolerancing per ASME Y14.5M.
2. This drawing is subject to change without notice.

# EXAMPLE BOARD LAYOUT

YKE0004

DSBGA - 0.445mm max height

DIE SIZE BALL GRID ARRAY

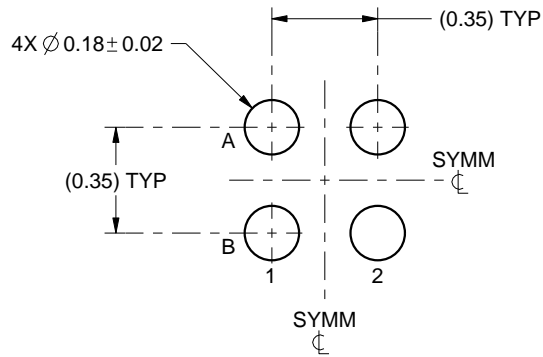

LAND PATTERN EXAMPLE  
SCALE:40X

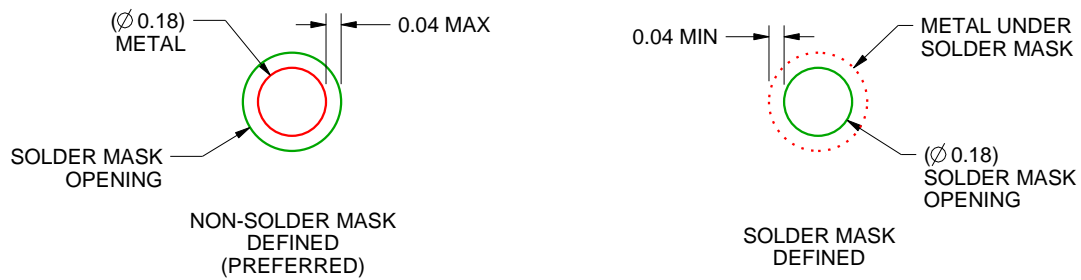

SOLDER MASK DETAILS  
NOT TO SCALE

4220102/A 11/2014

NOTES: (continued)

- Final dimensions may vary due to manufacturing tolerance considerations and also routing constraints. Refer to Texas Instruments Literature No. SNVA009 ([www.ti.com/lit/snva009](http://www.ti.com/lit/snva009)).



# EXAMPLE STENCIL DESIGN

YKE0004

DSBGA - 0.445mm max height

DIE SIZE BALL GRID ARRAY

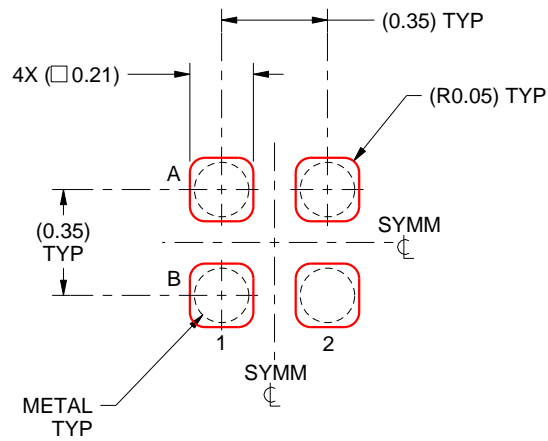

SOLDER PASTE EXAMPLE  
BASED ON 0.075 - 0.1mm THICK STENCIL  
SCALE:40X

4220102/A 11/2014

NOTES: (continued)

4. Laser cutting apertures with trapezoidal walls and rounded corners may offer better paste release.

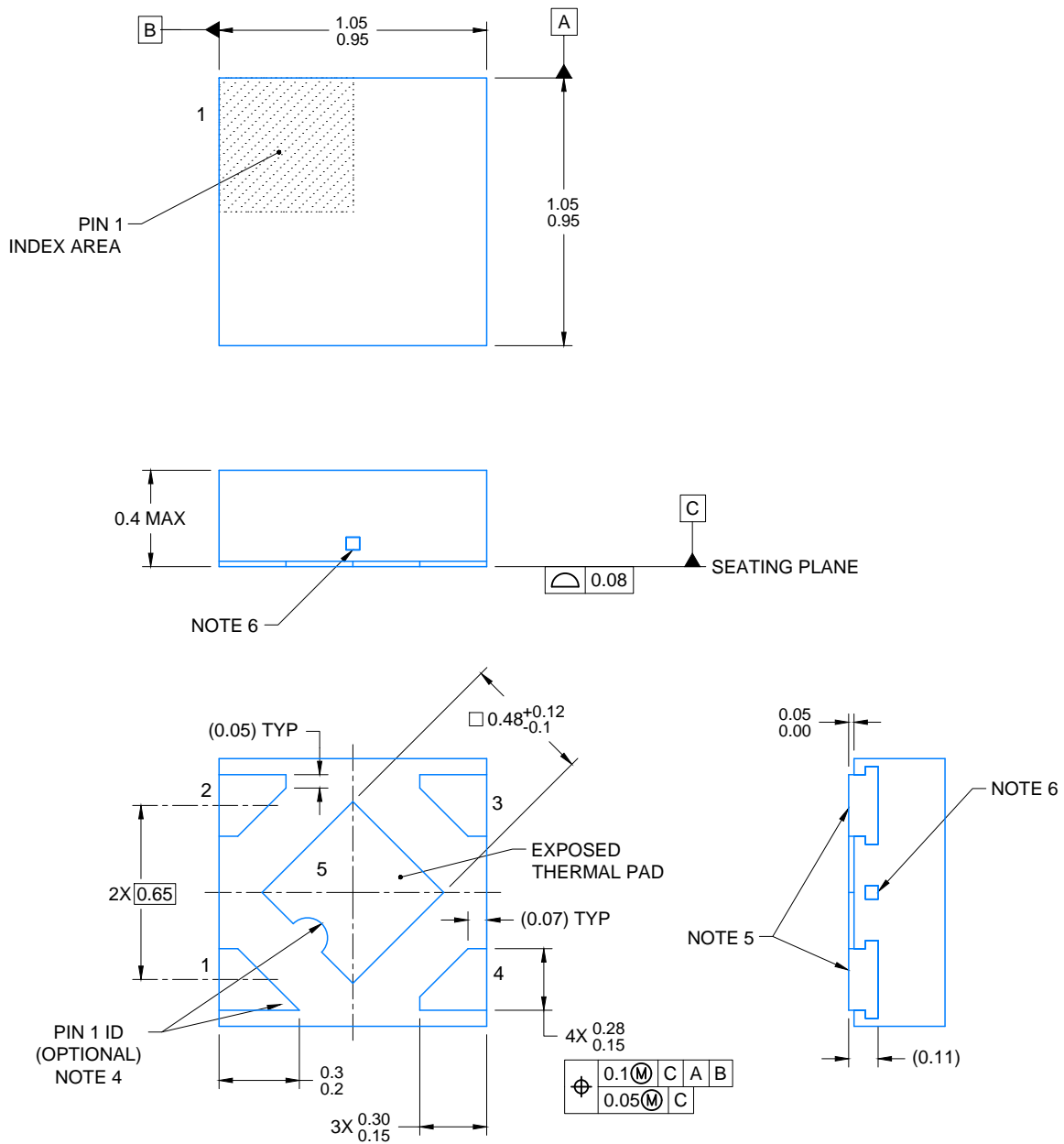

4215302/E 12/2016

NOTES:

1. All linear dimensions are in millimeters. Any dimensions in parenthesis are for reference only. Dimensioning and tolerancing per ASME Y14.5M.
2. This drawing is subject to change without notice.
3. The package thermal pad must be soldered to the printed circuit board for optimal thermal and mechanical performance.
4. Features may not exist. Recommend use of pin 1 marking on top of package for orientation purposes.
5. Shape of exposed side leads may differ.
6. Number and location of exposed tie bars may vary.

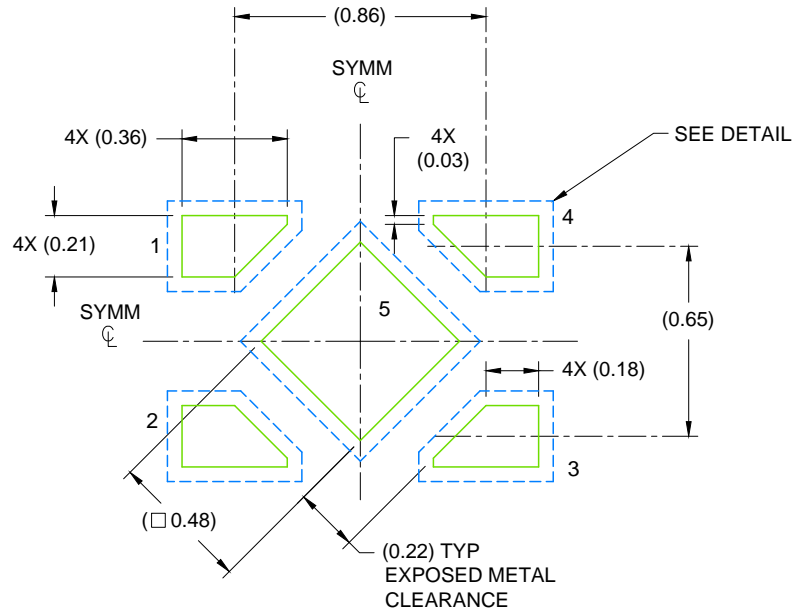

LAND PATTERN EXAMPLE  
SCALE: 40X

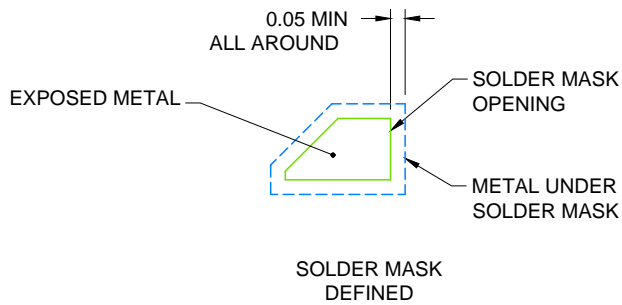

SOLDER MASK DETAIL

4215302/E 12/2016

NOTES: (continued)

7. This package is designed to be soldered to a thermal pad on the board. For more information, see Texas Instruments literature number SLUA271 ([www.ti.com/lit/sluea271](http://www.ti.com/lit/sluea271)).
8. If any vias are implemented, it is recommended that vias under paste be filled, plugged or tented.



SOLDER PASTE EXAMPLE  
 BASED ON 0.075 - 0.1mm THICK STENCIL  
 EXPOSED PAD  
 88% PRINTED SOLDER COVERAGE BY AREA  
 SCALE: 60X

4215302/E 12/2016

NOTES: (continued)

9. Laser cutting apertures with trapezoidal walls and rounded corners may offer better paste release. IPC-7525 may have alternate design recommendations.

## 重要通知和免责声明

TI“按原样”提供技术和可靠性数据（包括数据表）、设计资源（包括参考设计）、应用或其他设计建议、网络工具、安全信息和其他资源，不保证没有瑕疵且不做任何明示或暗示的担保，包括但不限于对适销性、某特定用途方面的适用性或不侵犯任何第三方知识产权的暗示担保。

这些资源可供使用 TI 产品进行设计的熟练开发人员使用。您将自行承担以下全部责任：(1) 针对您的应用选择合适的 TI 产品，(2) 设计、验证并测试您的应用，(3) 确保您的应用满足相应标准以及任何其他功能安全、信息安全、监管或其他要求。

这些资源如有变更，恕不另行通知。TI 授权您仅可将这些资源用于研发本资源所述的 TI 产品的相关应用。严禁以其他方式对这些资源进行复制或展示。您无权使用任何其他 TI 知识产权或任何第三方知识产权。您应全额赔偿因在这些资源的使用中对 TI 及其代表造成的任何索赔、损害、成本、损失和债务，TI 对此概不负责。

TI 提供的产品受 [TI 的销售条款](#) 或 [ti.com](#) 上其他适用条款/TI 产品随附的其他适用条款的约束。TI 提供这些资源并不会扩展或以其他方式更改 TI 针对 TI 产品发布的适用的担保或担保免责声明。

TI 反对并拒绝您可能提出的任何其他或不同的条款。

邮寄地址：Texas Instruments, Post Office Box 655303, Dallas, Texas 75265  
版权所有 © 2025，德州仪器 (TI) 公司