

1N47xxxPF

Silicon Planar Power Zener Diodes

for use in stabilizing and clipping circuits with high power rating. Standard zener voltage tolerance is $\pm 10\%$. Add suffix "A" for $\pm 5\%$ tolerance and suffix "B" for $\pm 2\%$ tolerance. Other tolerances are available upon request.

Features

- Lead Free

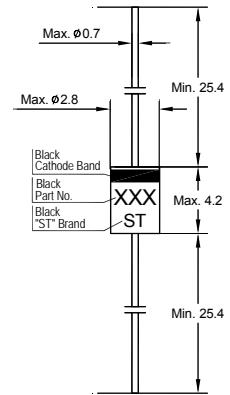

Glass Case DO-41
Dimensions in mm

Absolute Maximum Ratings ($T_a = 25^\circ\text{C}$)

Parameter	Symbol	Value	Unit
Power Dissipation ¹⁾	P_{tot}	1	W
Junction Temperature	T_j	175	$^\circ\text{C}$
Storage Temperature Range	T_{stg}	- 65 to + 175	$^\circ\text{C}$

Thermal Characteristics

Parameter	Symbol	Max.	Unit
Thermal Resistance Junction to Ambient Air ¹⁾	$R_{\theta\text{JA}}$	150	$^\circ\text{C/W}$

¹⁾ Valid provided that leads at a distance of 8 mm from case are kept at ambient temperature.

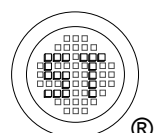

1N47xxxPF

Characteristics at $T_a = 25^\circ\text{C}$ (V_F max : 1.2 V at $I_F = 200$ mA)

Type	Zener Voltage Range ³⁾				Dynamic Resistance ¹⁾			Reverse Current		Maximum Surge Current ⁴⁾	Maximum Regulator Current ²⁾	Temperature coefficient at I_{ZT}
	V_{Znom}	V_{ZT}		at I_{ZT}	Z_{ZT}	Z_{ZK}	at I_{ZK}	I_R	at V_R			
	(V)	Min. (V)	Max. (V)	(mA)	Max. (Ω)	Max. (Ω)	(mA)	Max. (μA)	(V)	I_{ZSM} (mA)	I_{ZM} (mA)	%/ $^\circ\text{C}$
1N4727PF	3	2.7	3.3	83	10	400	1	150	1	1375	275	-0.08 to -0.05
1N4728PF	3.3	2.97	3.63	76	10	400	1	150	1	1375	275	-0.08 to -0.05
1N4729PF	3.6	3.24	3.96	69	10	400	1	100	1	1260	252	-0.08 to -0.05
1N4730PF	3.9	3.51	4.29	64	9	400	1	100	1	1190	234	-0.07 to -0.02
1N4731PF	4.3	3.87	4.73	58	9	400	1	50	1	1070	217	-0.07 to -0.01
1N4732PF	4.7	4.23	5.17	53	8	500	1	10	1	970	193	-0.03 to +0.04
1N4733PF	5.1	4.59	5.61	49	7	550	1	10	1	890	178	-0.01 to +0.04
1N4734PF	5.6	5.04	6.16	45	5	600	1	10	2	810	162	0.10 to +0.045
1N4735PF	6.2	5.58	6.82	41	2	700	1	10	3	730	146	+0.01 to +0.055
1N4736PF	6.8	6.12	7.48	37	3.5	700	1	10	4	660	133	+0.015 to +0.06
1N4737PF	7.5	6.75	8.25	34	4	700	0.5	10	5	605	121	+0.02 to +0.065
1N4738PF	8.2	7.38	9.02	31	4.5	700	0.5	10	6	550	110	0.03 to 0.07
1N4739PF	9.1	8.19	10.01	28	5	700	0.5	10	7	500	100	0.035 to 0.075
1N4740PF	10	9	11	25	7	700	0.25	10	7.6	454	91	0.04 to 0.08
1N4741PF	11	9.9	12.1	23	8	700	0.25	5	8.4	414	83	0.045 to 0.08
1N4742PF	12	10.8	13.2	21	9	700	0.25	5	9.1	380	76	0.045 to 0.085
1N4743PF	13	11.7	14.3	19	10	700	0.25	5	9.9	344	69	0.05 to 0.085
1N4744PF	15	13.5	16.5	17	14	700	0.25	5	11.4	304	61	0.055 to 0.09
1N4745PF	16	14.4	17.6	15.5	16	700	0.25	5	12.2	285	57	0.055 to 0.09
1N4746PF	18	16.2	19.8	14	20	750	0.25	5	13.7	250	50	0.06 to 0.09
1N4747PF	20	18	22	12.5	22	750	0.25	5	15.2	225	45	0.06 to 0.09
1N4748PF	22	19.8	24.2	11.5	23	750	0.25	5	16.7	205	41	0.06 to 0.095
1N4749PF	24	21.6	26.4	10.5	25	750	0.25	5	18.2	190	38	0.06 to 0.095
1N4750PF	27	24.3	29.7	9.5	35	750	0.25	5	20.6	170	34	0.06 to 0.095
1N4751PF	30	27	33	8.5	40	1000	0.25	5	22.8	150	30	0.06 to 0.095
1N4752PF	33	29.7	36.3	7.5	45	1000	0.25	5	25.1	135	27	0.06 to 0.095
1N4753PF	36	32.4	39.6	7	50	1000	0.25	5	27.4	125	25	0.06 to 0.095
1N4754PF	39	35.1	42.9	6.5	60	1000	0.25	5	29.7	115	23	0.06 to 0.095
1N4755PF	43	38.7	47.3	6	70	1500	0.25	5	32.7	110	22	0.06 to 0.095
1N4756PF	47	42.3	51.7	5.5	80	1500	0.25	5	35.8	95	19	0.06 to 0.095
1N4757PF	51	45.9	56.1	5	95	1500	0.25	5	38.8	90	18	0.06 to 0.095
1N4758PF	56	50.4	61.6	4.5	110	2000	0.25	5	42.6	80	16	0.06 to 0.095
1N4759PF	62	55.8	68.2	4	125	2000	0.25	5	47.1	70	14	0.06 to 0.095
1N4760PF	68	61.2	74.8	3.7	150	2000	0.25	5	51.7	65	13	0.06 to 0.095
1N4761PF	75	67.5	82.5	3.3	175	2000	0.25	5	56	60	12	0.06 to 0.095

¹⁾ The dynamic resistance is derived from the 60 Hz AC voltage which results when an AC current having an RMS value equal to 10% of the Zener Current (I_{ZT} or I_{ZK}) is superimposed on I_{ZT} or I_{ZK} . Dynamic resistance is measured at two points to insure a sharp knee on the breakdown curve and to eliminate unstable units.

²⁾ Valid provided that leads at a distance of 8 mm from case are kept at ambient temperature.

³⁾ Tested with pulses $t_p = 20$ ms.

⁴⁾ The rating listed in the electrical characteristics table is maximum peak, non-repetitive, reverse surge current of 1/2 square wave or equivalent sine wave pulse of 1/120 second duration superimposed on the test current I_{ZT} .

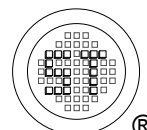

1N47xxxPF

Characteristics at $T_a = 25^\circ\text{C}$ (V_F max : 1.2 V at $I_F = 200$ mA)

Type	Zener Voltage Range ³⁾				Dynamic Resistance ¹⁾			Reverse Current		Maximum Surge Current ⁴⁾	Maximum Regulator Current ²⁾	Temperature coefficient at I_{ZT}
	V_{Znom}	V_{ZT}		at I_{ZT}	Z_{ZT}	Z_{ZK}	at I_{ZK}	I_R	at V_R			
	(V)	Min. (V)	Max. (V)	(mA)	Max. (Ω)	Max. (Ω)	(mA)	Max. (μA)	(V)	I_{ZSM} (mA)	I_{ZM} (mA)	%/ $^\circ\text{C}$
1N4727APF	3	2.85	3.15	83	10	400	1	150	1	1375	275	-0.08 to -0.05
1N4728APF	3.3	3.14	3.47	76	10	400	1	150	1	1375	275	-0.08 to -0.05
1N4729APF	3.6	3.42	3.78	69	10	400	1	100	1	1260	252	-0.08 to -0.05
1N4730APF	3.9	3.71	4.1	64	9	400	1	100	1	1190	234	-0.07 to -0.02
1N4731APF	4.3	4.09	4.52	58	9	400	1	50	1	1070	217	-0.07 to -0.01
1N4732APF	4.7	4.47	4.94	53	8	500	1	10	1	970	193	-0.03 to +0.04
1N4733APF	5.1	4.85	5.36	49	7	550	1	10	1	890	178	-0.01 to +0.04
1N4734APF	5.6	5.32	5.88	45	5	600	1	10	2	810	162	0.10 to +0.045
1N4735APF	6.2	5.89	6.51	41	2	700	1	10	3	730	146	+0.01 to +0.055
1N4736APF	6.8	6.46	7.14	37	3.5	700	1	10	4	660	133	+0.015 to +0.06
1N4737APF	7.5	7.13	7.88	34	4	700	0.5	10	5	605	121	+0.02 to +0.065
1N4738APF	8.2	7.79	8.61	31	4.5	700	0.5	10	6	550	110	0.03 to 0.07
1N4739APF	9.1	8.65	9.56	28	5	700	0.5	10	7	500	100	0.035 to 0.075
1N4740APF	10	9.5	10.5	25	7	700	0.25	10	7.6	454	91	0.04 to 0.08
1N4741APF	11	10.45	11.55	23	8	700	0.25	5	8.4	414	83	0.045 to 0.08
1N4742APF	12	11.4	12.6	21	9	700	0.25	5	9.1	380	76	0.045 to 0.085
1N4743APF	13	12.35	13.65	19	10	700	0.25	5	9.9	344	69	0.05 to 0.085
1N4744APF	15	14.25	15.75	17	14	700	0.25	5	11.4	304	61	0.055 to 0.09
1N4745APF	16	15.2	16.8	15.5	16	700	0.25	5	12.2	285	57	0.055 to 0.09
1N4746APF	18	17.1	18.9	14	20	750	0.25	5	13.7	250	50	0.06 to 0.09
1N4747APF	20	19	21	12.5	22	750	0.25	5	15.2	225	45	0.06 to 0.09
1N4748APF	22	20.9	23.1	11.5	23	750	0.25	5	16.7	205	41	0.06 to 0.095
1N4749APF	24	22.8	25.2	10.5	25	750	0.25	5	18.2	190	38	0.06 to 0.095
1N4750APF	27	25.65	28.35	9.5	35	750	0.25	5	20.6	170	34	0.06 to 0.095
1N4751APF	30	28.5	31.5	8.5	40	1000	0.25	5	22.8	150	30	0.06 to 0.095
1N4752APF	33	31.35	34.65	7.5	45	1000	0.25	5	25.1	135	27	0.06 to 0.095
1N4753APF	36	34.2	37.8	7	50	1000	0.25	5	27.4	125	25	0.06 to 0.095
1N4754APF	39	37.05	40.95	6.5	60	1000	0.25	5	29.7	115	23	0.06 to 0.095
1N4755APF	43	40.85	45.15	6	70	1500	0.25	5	32.7	110	22	0.06 to 0.095
1N4756APF	47	44.65	49.35	5.5	80	1500	0.25	5	35.8	95	19	0.06 to 0.095
1N4757APF	51	48.45	53.55	5	95	1500	0.25	5	38.8	90	18	0.06 to 0.095
1N4758APF	56	53.2	58.8	4.5	110	2000	0.25	5	42.6	80	16	0.06 to 0.095
1N4759APF	62	58.9	65.1	4	125	2000	0.25	5	47.1	70	14	0.06 to 0.095
1N4760APF	68	64.6	71.4	3.7	150	2000	0.25	5	51.7	65	13	0.06 to 0.095
1N4761APF	75	71.25	78.75	3.3	175	2000	0.25	5	56	60	12	0.06 to 0.095

¹⁾ The dynamic resistance is derived from the 60 Hz AC voltage which results when an AC current having an RMS value equal to 10% of the Zener Current (I_{ZT} or I_{ZK}) is superimposed on I_{ZT} or I_{ZK} . Dynamic resistance is measured at two points to insure a sharp knee on the breakdown curve and to eliminate unstable units.

²⁾ Valid provided that leads at a distance of 8 mm from case are kept at ambient temperature.

³⁾ Tested with pulses $t_p = 20$ ms.

⁴⁾ The rating listed in the electrical characteristics table is maximum peak, non-repetitive, reverse surge current of 1/2 square wave or equivalent sine wave pulse of 1/120 second duration superimposed on the test current I_{ZT} .

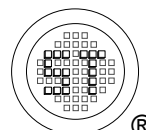

1N47xxxPF

Characteristics at $T_a = 25^\circ\text{C}$ (V_F max : 1.2 V at $I_F = 200$ mA)

Type	Zener Voltage Range ³⁾				Dynamic Resistance ¹⁾			Reverse Current		Maximum Surge Current ⁴⁾	Maximum Regulator Current ²⁾	Temperature coefficient at I_{ZT}
	V_{Znom}	V_{ZT}		at I_{ZT}	Z_{ZT}	Z_{ZK}	at I_{ZK}	I_R	at V_R			
	(V)	Min. (V)	Max. (V)	(mA)	Max. (Ω)	Max. (Ω)	(mA)	Max. (μA)	(V)	I_{ZSM} (mA)	I_{ZM} (mA)	%/ $^\circ\text{C}$
1N4727BPF	3	2.94	3.06	83	10	400	1	150	1	1375	275	-0.08 to -0.05
1N4728BPF	3.3	3.23	3.37	76	10	400	1	150	1	1375	275	-0.08 to -0.05
1N4729BPF	3.6	3.53	3.67	69	10	400	1	100	1	1260	252	-0.08 to -0.05
1N4730BPF	3.9	3.82	3.98	64	9	400	1	100	1	1190	234	-0.07 to -0.02
1N4731BPF	4.3	4.21	4.39	58	9	400	1	50	1	1070	217	-0.07 to -0.01
1N4732BPF	4.7	4.61	4.79	53	8	500	1	10	1	970	193	-0.03 to +0.04
1N4733BPF	5.1	5	5.2	49	7	550	1	10	1	890	178	-0.01 to +0.04
1N4734BPF	5.6	5.49	5.71	45	5	600	1	10	2	810	162	0.10 to +0.045
1N4735BPF	6.2	6.08	6.32	41	2	700	1	10	3	730	146	+0.01 to +0.055
1N4736BPF	6.8	6.66	6.94	37	3.5	700	1	10	4	660	133	+0.015 to +0.06
1N4737BPF	7.5	7.35	7.65	34	4	700	0.5	10	5	605	121	+0.02 to +0.065
1N4738BPF	8.2	8.04	8.36	31	4.5	700	0.5	10	6	550	110	0.03 to 0.07
1N4739BPF	9.1	8.92	9.28	28	5	700	0.5	10	7	500	100	0.035 to 0.075
1N4740BPF	10	9.8	10.2	25	7	700	0.25	10	7.6	454	91	0.04 to 0.08
1N4741BPF	11	10.78	11.22	23	8	700	0.25	5	8.4	414	83	0.045 to 0.08
1N4742BPF	12	11.76	12.24	21	9	700	0.25	5	9.1	380	76	0.045 to 0.085
1N4743BPF	13	12.74	13.26	19	10	700	0.25	5	9.9	344	69	0.05 to 0.085
1N4744BPF	15	14.70	15.30	17	14	700	0.25	5	11.4	304	61	0.055 to 0.09
1N4745BPF	16	15.68	16.32	15.5	16	700	0.25	5	12.2	285	57	0.055 to 0.09
1N4746BPF	18	17.64	18.36	14	20	750	0.25	5	13.7	250	50	0.06 to 0.09
1N4747BPF	20	19.6	20.4	12.5	22	750	0.25	5	15.2	225	45	0.06 to 0.09
1N4748BPF	22	21.56	22.44	11.5	23	750	0.25	5	16.7	205	41	0.06 to 0.095
1N4749BPF	24	23.52	24.48	10.5	25	750	0.25	5	18.2	190	38	0.06 to 0.095
1N4750BPF	27	26.46	27.54	9.5	35	750	0.25	5	20.6	170	34	0.06 to 0.095
1N4751BPF	30	29.4	30.6	8.5	40	1000	0.25	5	22.8	150	30	0.06 to 0.095
1N4752BPF	33	32.34	33.66	7.5	45	1000	0.25	5	25.1	135	27	0.06 to 0.095
1N4753BPF	36	35.28	36.72	7	50	1000	0.25	5	27.4	125	25	0.06 to 0.095
1N4754BPF	39	38.22	39.78	6.5	60	1000	0.25	5	29.7	115	23	0.06 to 0.095
1N4755BPF	43	42.14	43.86	6	70	1500	0.25	5	32.7	110	22	0.06 to 0.095
1N4756BPF	47	46.06	47.94	5.5	80	1500	0.25	5	35.8	95	19	0.06 to 0.095
1N4757BPF	51	49.98	52.02	5	95	1500	0.25	5	38.8	90	18	0.06 to 0.095
1N4758BPF	56	54.88	57.12	4.5	110	2000	0.25	5	42.6	80	16	0.06 to 0.095
1N4759BPF	62	60.76	63.24	4	125	2000	0.25	5	47.1	70	14	0.06 to 0.095
1N4760BPF	68	66.64	69.36	3.7	150	2000	0.25	5	51.7	65	13	0.06 to 0.095
1N4761BPF	75	73.5	76.5	3.3	175	2000	0.25	5	56	60	12	0.06 to 0.095

¹⁾ The dynamic resistance is derived from the 60 Hz AC voltage which results when an AC current having an RMS value equal to 10% of the Zener Current (I_{ZT} or I_{ZK}) is superimposed on I_{ZT} or I_{ZK} . Dynamic resistance is measured at two points to insure a sharp knee on the breakdown curve and to eliminate unstable units.

²⁾ Valid provided that leads at a distance of 8 mm from case are kept at ambient temperature.

³⁾ Tested with pulses $t_p = 20$ ms.

⁴⁾ The rating listed in the electrical characteristics table is maximum peak, non-repetitive, reverse surge current of 1/2 square wave or equivalent sine wave pulse of 1/120 second duration superimposed on the test current I_{ZT} .

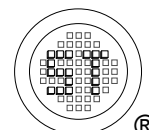

1N47xxxPF

Electrical Characteristics Curves

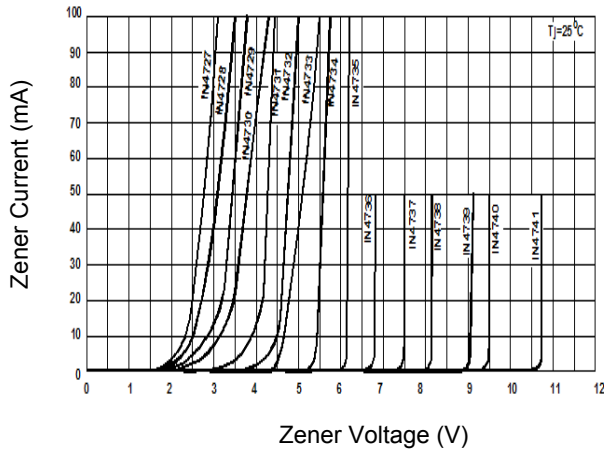

Fig 1. Zener Characteristics Curve

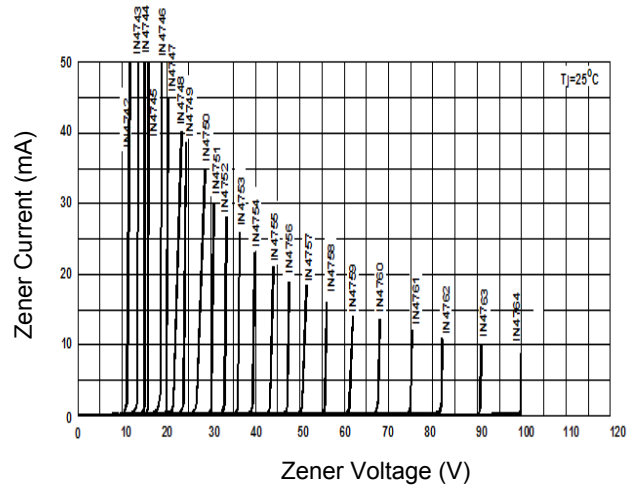

Fig 2. Zener Characteristics Curve

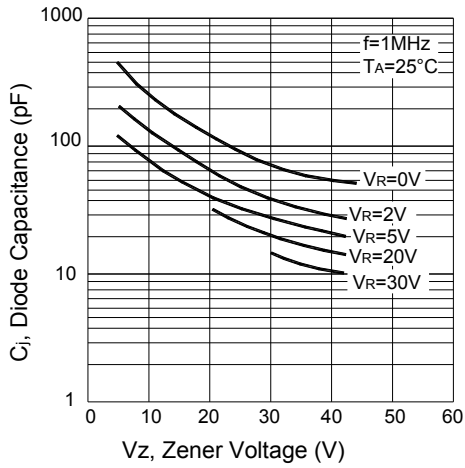

Fig 3. Junction Capacitance vs Zener Voltage

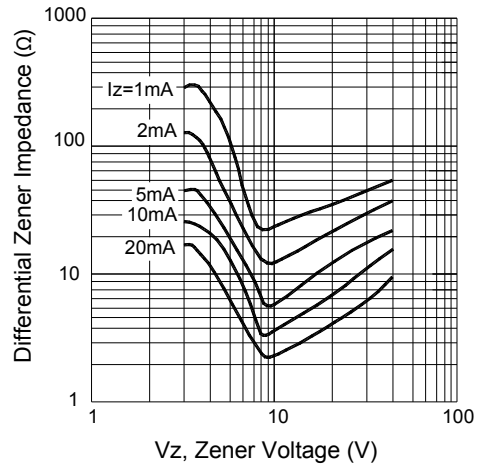

Fig 4. Typical Zener Impedance vs. Zener Voltage

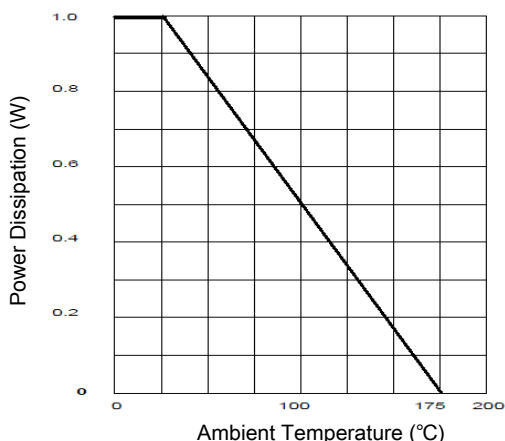

Fig 5. Power Derating Curve

