



High Quality Audio J-FET Input Dual Operational Amplifier

■ GENERAL DESCRIPTION

The MUSES8920 is a high quality audio J-FET input dual operational amplifier, which is optimized for high-end audio, professional audio and portable audio applications.

It is suitable for audio preamplifiers, active filters, and line amplifiers. In addition, J-FET input type has advantage of the low input bias current, it is suitable for transimpedance amplifier (I/V converter).

■ FEATURES

- Operating Voltage $\pm 3.5V$ to $\pm 17V$
- Low Noise $8nV/\sqrt{Hz}$ typ.
- THD 0.0004% typ. ($A_v=1$)
- Slew Rate $25V/\mu s$ typ.
- GBW 11MHz typ.
- High Output Current 100mA typ. (short-circuit current)
- J-FET Input
- Bipolar Technology
- Package Outline DIP8, SOP8 JEDEC 150mil
DFN8-X7 (ESON8-X7)(3.5mm x 4.0mm)

■ APPLICATIONS

- Portable Audio
- Home Audio
- Professional Audio
- Car Audio

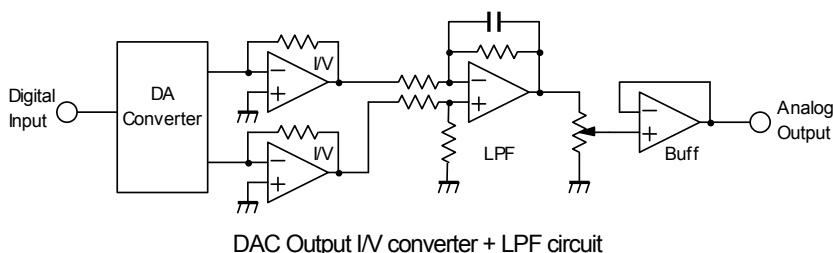

■ PACKAGE OUTLINE



MUSES8920D
(DIP8)



MUSES8920E
(SOP8 JEDEC 150mil (EMP8))



MUSES8920KX7
(DFN8-X7 (ESON8-X7))

■ PIN CONFIGURATION

DIP8, SOP8 JEDEC 150mil

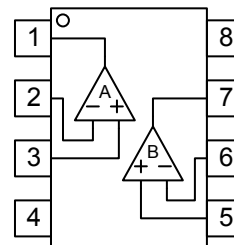

1. A OUTPUT
2. A-INPUT
3. A+INPUT
4. V-
5. B+INPUT
6. B-INPUT
7. B OUTPUT
8. V+

DFN8-X7 (ESON8-X7)

Top View

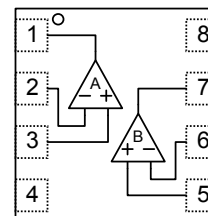

Bottom View

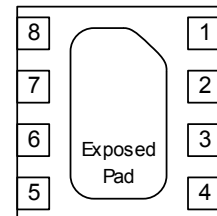

About Exposed Pad

Connect the Exposed Pad on the GND.

MUSES8920

■ ABSOLUTE MAXIMUM RATING (Ta=25°C unless otherwise specified)

PARAMETER	SYMBOL	RATING	UNIT
Supply Voltage	V^+V^-	±18	V
Differential Input Voltage Range	V_{ID}	±30	V
Common Mode Input Voltage Range	V_{ICM}	±15 ^(Note1)	V
Power Dissipation	P_D	DIP8:870 SOP8:900 ^(Note2) DFN8-X7: 690 ^(Note2) 2900 ^(Note3)	mW
Operating Temperature Range	Topr	-40 to +125	°C
Storage Temperature Range	Tstg	-50 to +150	°C

(Note1) For supply Voltages less than ±15 V, the maximum input voltage is equal to the Supply Voltage.

(Note2) Mounted on the EIA/JEDEC standard board (114.3×76.2×1.6mm, two layer, FR-4). DFN8 is connecting to GND in the center part on the back.

(Note3) EIA/JEDEC STANDARD Test board (76.2 x 114.3 x 1.6mm, 4layers, FR-4, Applying a thermal via hole to a board based on JEDEC standard JESD51-5) mounting. The PAD connecting to GND in the center part on the back.

(Note4) NJM8920 is ESD (electrostatic discharge) sensitive device.

Therefore, proper ESD precautions are recommended to avoid permanent damage or loss of functionality.

■ RECOMMENDED OPERATING VOLTAGE (Ta=25°C)

PARAMETER	SYMBOL	TEST CONDITION	MIN.	TYP.	MAX.	UNIT
Supply Voltage	V^+V^-		±3.5	-	±17	V

■ ELECTRICAL CHARACTERISTICS

● DC CHARACTERISTICS (V^+V^- =±15V, Ta=25°C, unless otherwise specified)

PARAMETER	SYMBOL	TEST CONDITION	MIN.	TYP.	MAX.	UNIT
Supply Current	I_{CC}	$R_L=\infty$, No Signal	-	9	12	mA
Input Offset Voltage	V_{IO}	$R_S=50\Omega$,	-	0.8	5	mV
Input Bias Current	I_B		-	5	250	pA
Input Offset Current	I_{IO}		-	2	220	pA
Voltage Gain1	A_{V1}	$R_L=10k\Omega$, $V_o=\pm 13V$	106	135	-	dB
Voltage Gain2	A_{V2}	$R_L=2k\Omega$, $V_o=\pm 12.8V$	105	133	-	dB
Voltage Gain3	A_{V3}	$R_L=600\Omega$, $V_o=12.5V$	105	130	-	dB
Common Mode Rejection Ratio	CMR	$V_{ICM}=\pm 12.5V$ ^(Note5)	80	110	-	dB
Supply Voltage Rejection Ratio	SVR	V^+V^- =±3.5 to ±17V ^(Note6)	80	110	-	dB
Maximum Output Voltage1	V_{OM1}	$R_L=10k\Omega$	±13	±14	-	V
Maximum Output Voltage2	V_{OM2}	$R_L=2k\Omega$	±12.8	±13.8	-	V
Maximum Output Voltage3	V_{OM3}	$R_L=600\Omega$	±12.5	±13.5	-	V
Common Mode Input Voltage Range	V_{ICM}	CMR≥80dB	±12.5	±14	-	V

(Note5) CMR is calculated by specified change in offset voltage. ($V_{ICM}=0V$ to +12.5V, $V_{ICM}=0V$ to -12.5V)

(Note6) SVR is calculated by specified change in offset voltage. (V^+V^- =±3.5 to ±17V)

● AC CHARACTERISTICS (V^+V^- =±15V, Ta=25°C, unless otherwise specified)

PARAMETER	SYMBOL	TEST CONDITION	MIN.	TYP.	MAX.	UNIT
Gain Bandwidth Product	GB	f=10kHz	-	11	-	MHz
Unity Gain Frequency	f_T	$A_V=+100$, $R_S=100\Omega$, $R_L=2k\Omega$, $C_L=10pF$	-	10	-	MHz
Phase Margin	Φ_M	$A_V=+100$, $R_S=100\Omega$, $R_L=2k\Omega$, $C_L=10pF$	-	70	-	Deg
Equivalent Input Noise Voltage1	V_{NI1}	f=1kHz	-	8	-	nV/√Hz
Equivalent Input Noise Voltage2	V_{NI2}	RIAA, $R_S=2.2k\Omega$, 30kHz, LPF ^(Note7)	-	1.1	3.5	μVrms
Equivalent Input Noise Voltage3	V_{NI3}	f=20 to 20kHz ^(Note8)	-	1.1	-	μVrms
Total Harmonic Distortion	THD	f=1kHz, $A_V=+10$, $V_o=5Vrms$, $R_L=2k\Omega$	-	0.0004	-	%
Channel Separation	CS	f=1kHz, $A_V=-100$, $R_L=2k\Omega$	-	150	-	dB
Slew Rate	SR	$A_V=1$, $V_{IN}=2Vp-p$, $R_L=2k\Omega$, $C_L=10pF$	-	25	-	V/us

(Note7) DIP8 and SOP8

(Note8) DFN8-X7

■ POWER DISSIPATION vs. AMBIENT TEMPERATURE

IC is heated by own operation and possibly gets damage when the junction power exceeds the acceptable value called Power Dissipation P_D . The dependence of the MUSES8920 P_D on ambient temperature is shown in Fig 1. The plots are depended on following two points. The first is P_D on ambient temperature 25°C, which is the maximum power dissipation. The second is 0W, which means that the IC cannot radiate any more. Conforming the maximum junction temperature T_{jmax} to the storage temperature T_{stg} derives this point. Fig.1 is drawn by connecting those points and conforming the P_D lower than 25°C to it on 25°C. The P_D is shown following formula as a function of the ambient temperature between those points.

$$\text{Dissipation Power } P_D = \frac{T_{jmax} - T_a}{\theta_{ja}} \text{ [W]} \quad (T_a=25^\circ\text{C to } T_a=150^\circ\text{C})$$

Where, θ_{ja} is heat thermal resistance which depends on parameters such as package material, frame material and so on. Therefore, P_D is different in each package.

While, the actual measurement of dissipation power on MUSES8920 is obtained using following equation.

$$(\text{Actual Dissipation Power}) = (\text{Supply Current } I_{cc}) \times (\text{Supply Voltage } V^+ - V^-) - (\text{Output Power } P_o)$$

The MUSES8920 should be operated in lower than P_D of the actual dissipation power.

To sustain the steady state operation, take account of the Dissipation Power and thermal design.

Fig 1

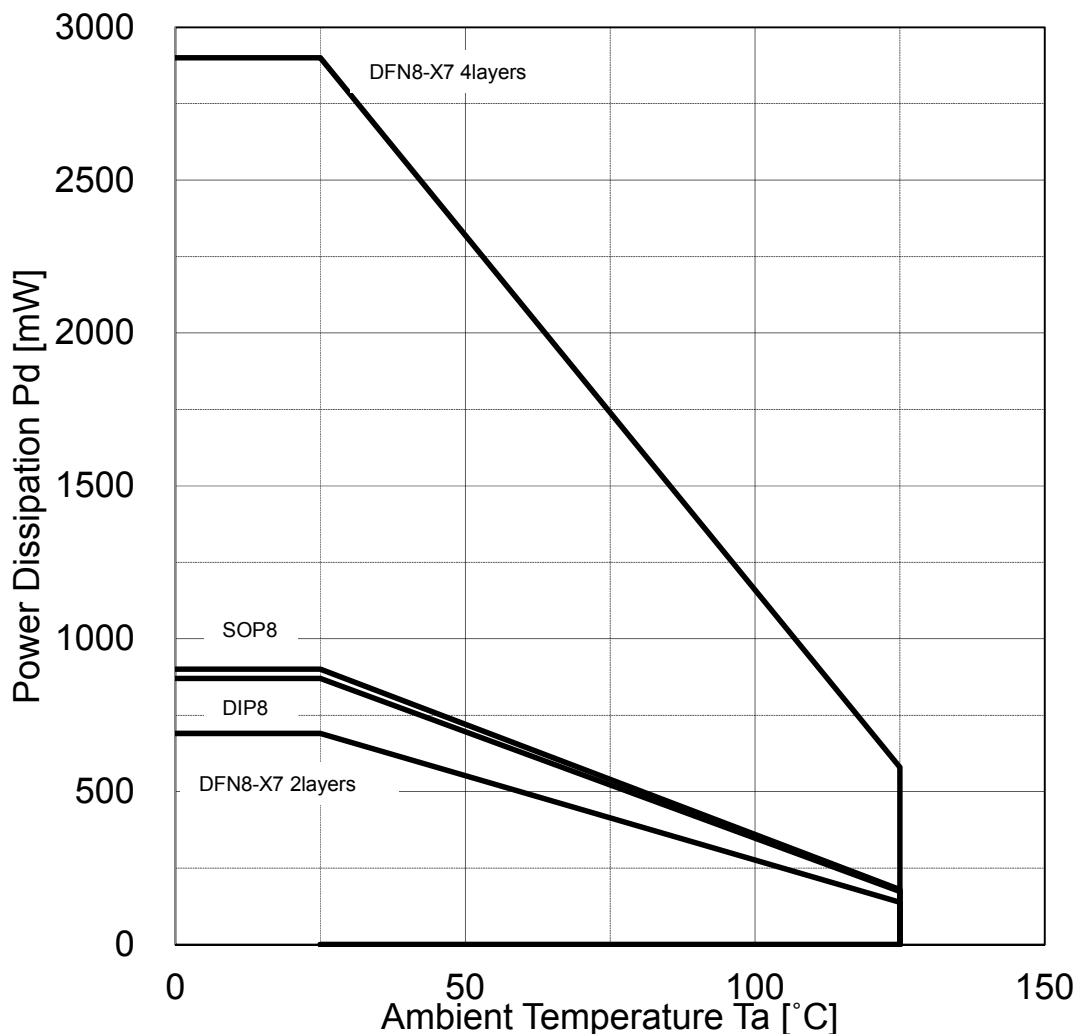

TYPICAL CHARACTERISTICS

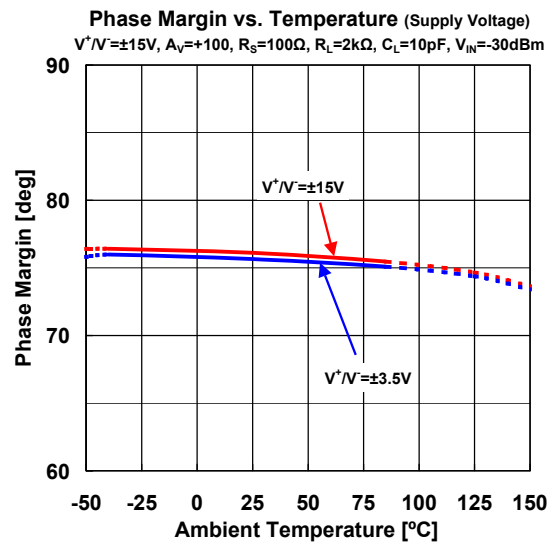
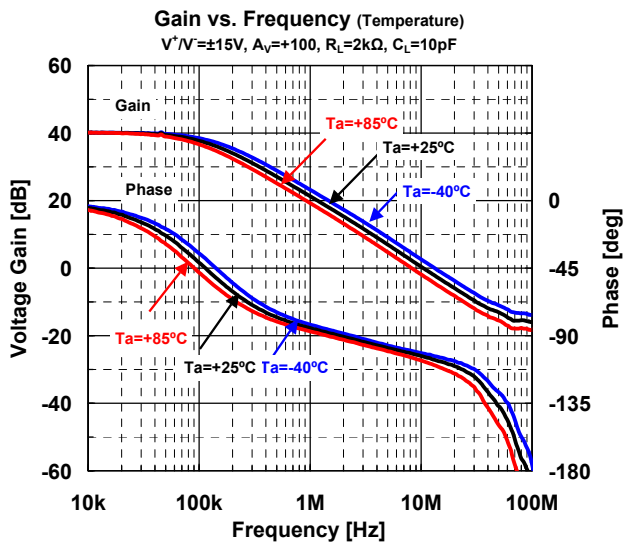
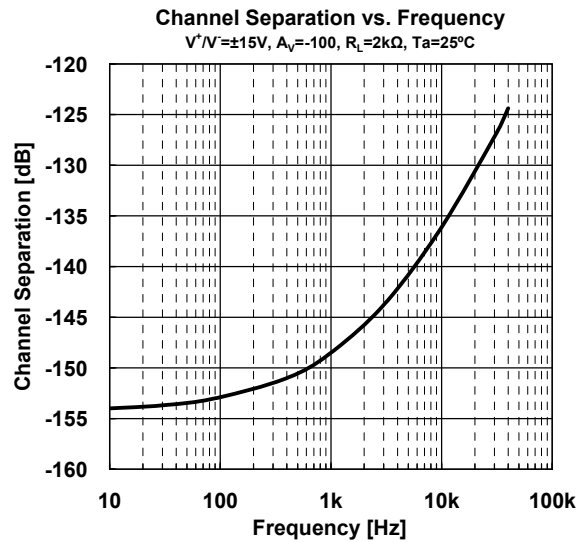
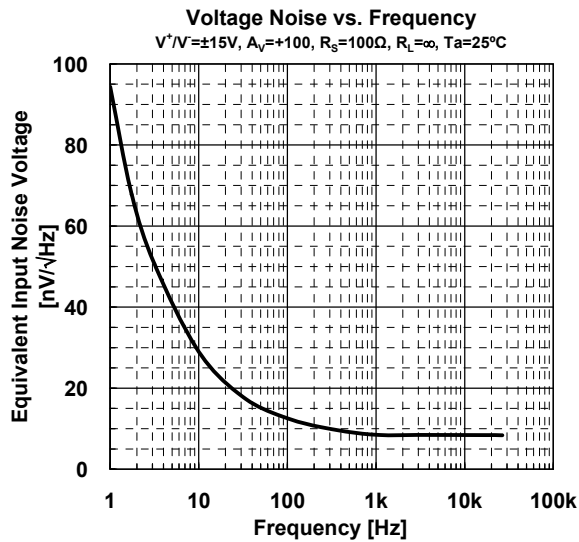
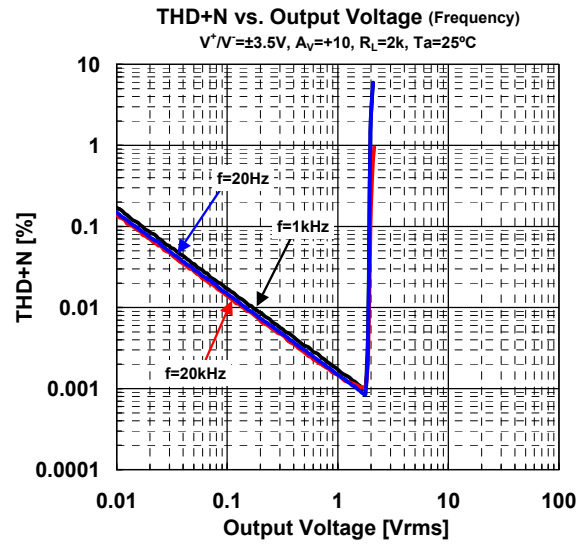
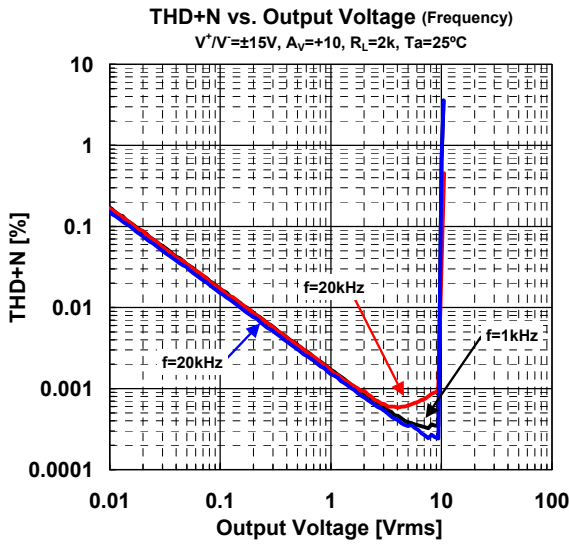

MUSES8920

TYPICAL CHARACTERISTICS

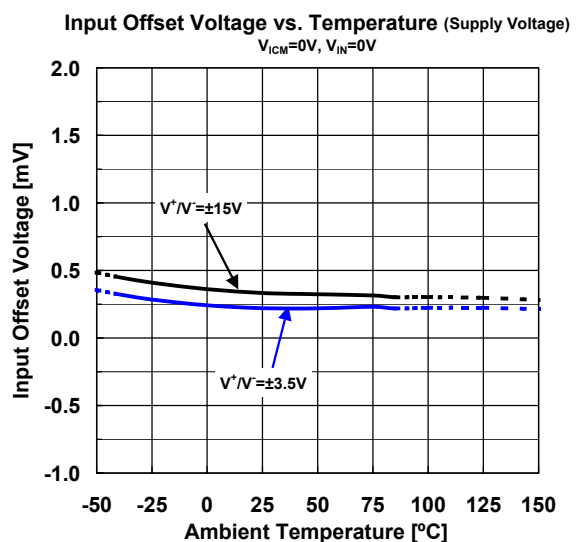
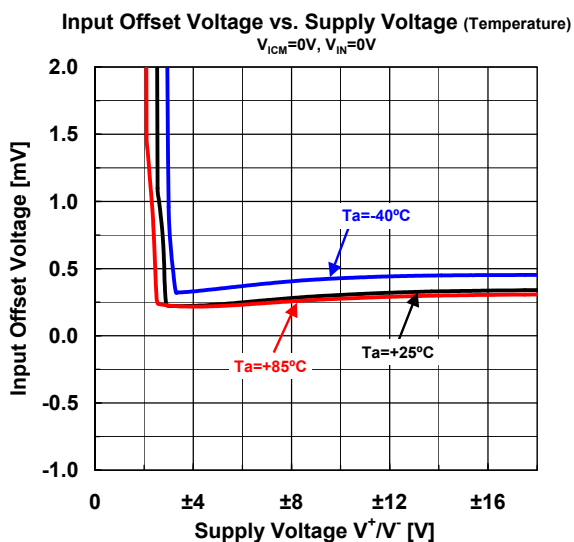
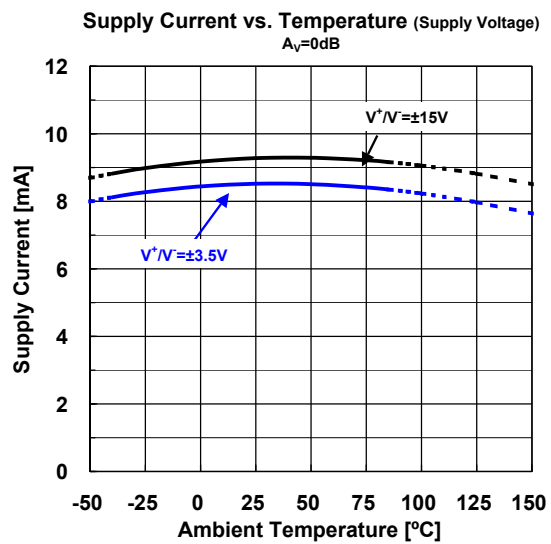
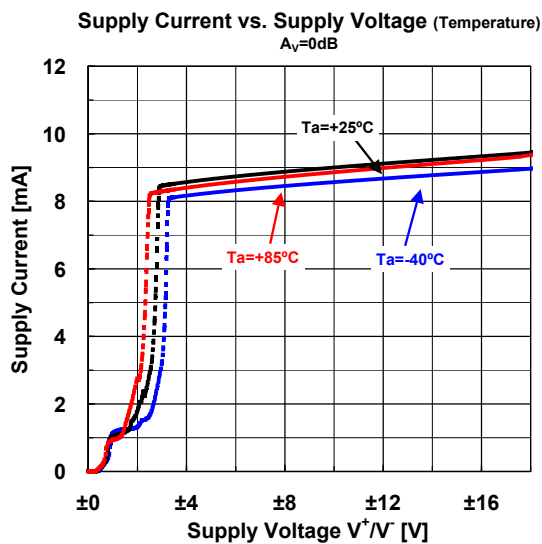
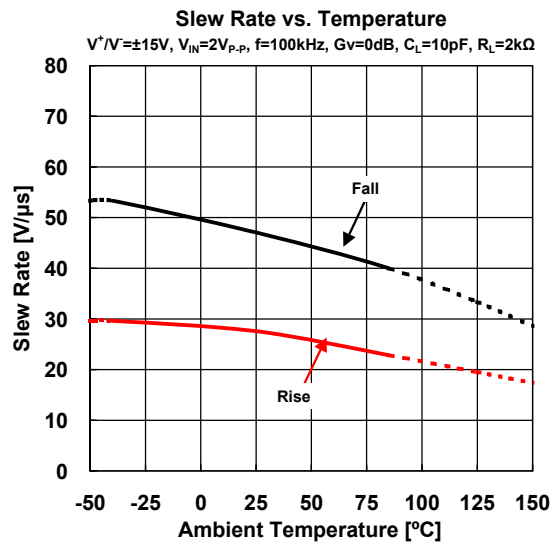
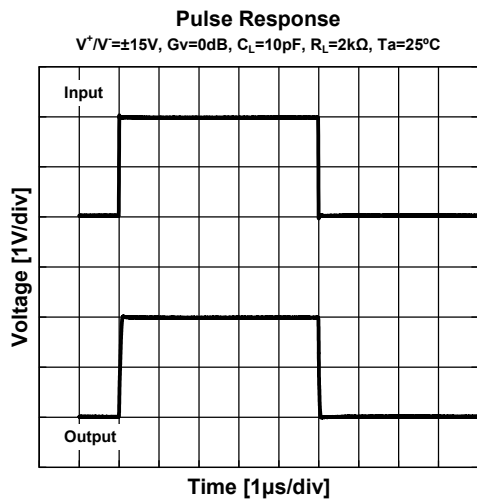

■ TYPICAL CHARACTERISTICS

Input Offset Voltage
vs. Common Mode Input Voltage
(Temperature)
 $V^+/V^- = \pm 15V$

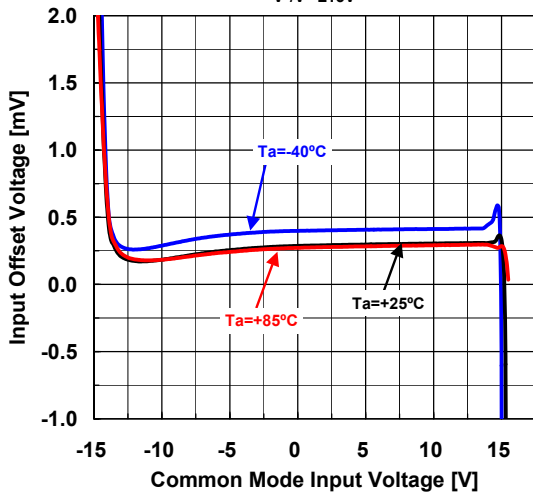

Input Offset Voltage
vs. Common Mode Input Voltage
(Temperature)
 $V^+/V^- = \pm 3.5V$

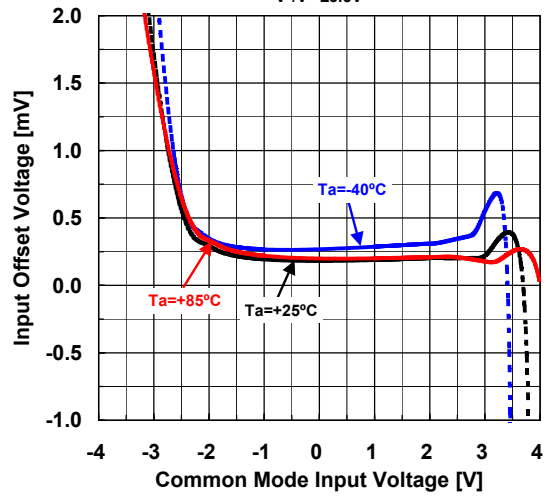

Input Bias Current vs. Temperature (Supply Voltage)
 $V_{ICM} = 0V, V^+/V^- = \pm 15V$

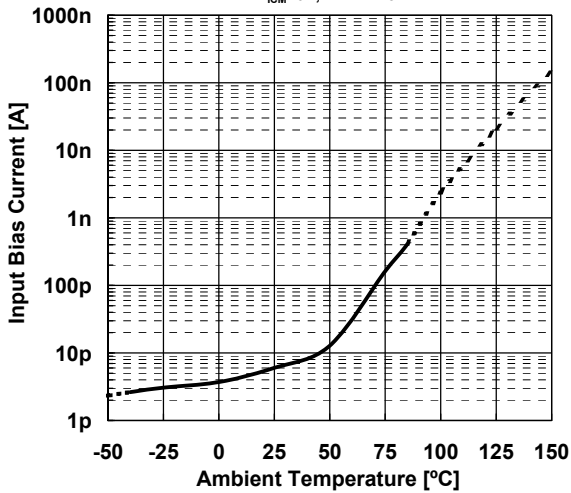

Input Bias Current vs. Common Mode Input Voltage
(Temperature)
 $V^+/V^- = \pm 15V, T_a = 25^\circ C$

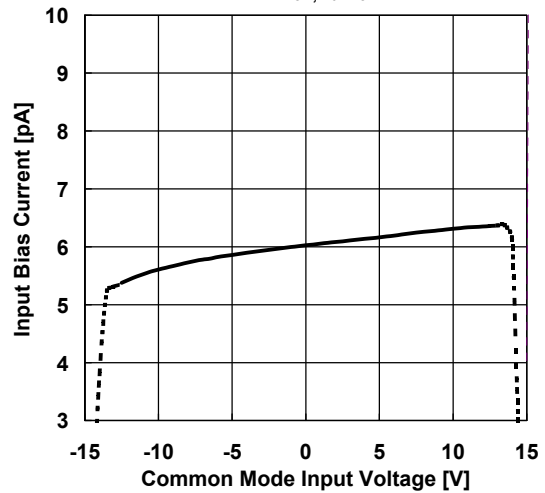

CMR vs. Temperature
 $V^+/V^- = \pm 15V$

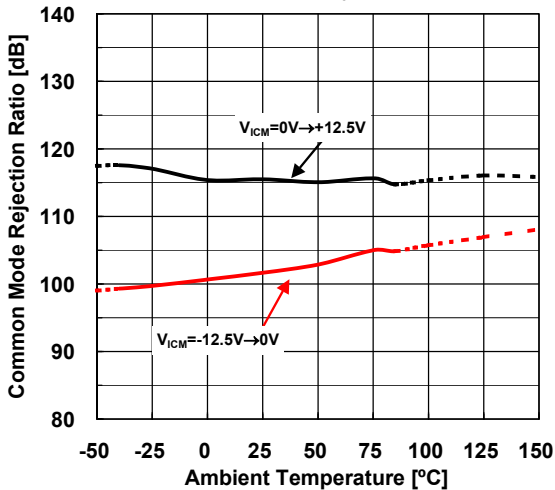

SVR vs. Temperature
 $V_{ICM} = 0V, V^+/V^- = \pm 3.5V \rightarrow \pm 16V$

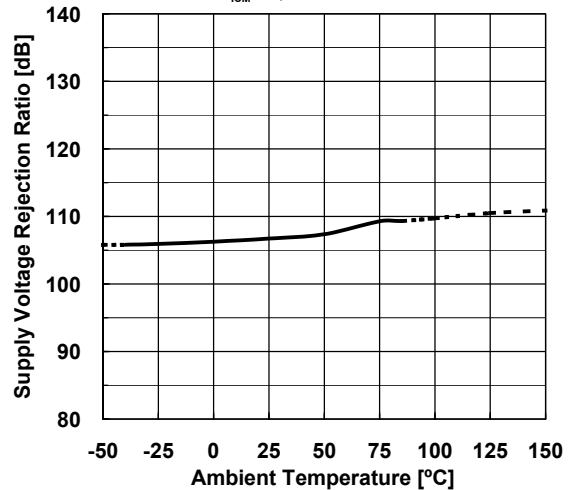

MUSES8920

■ TYPICAL CHARACTERISTICS

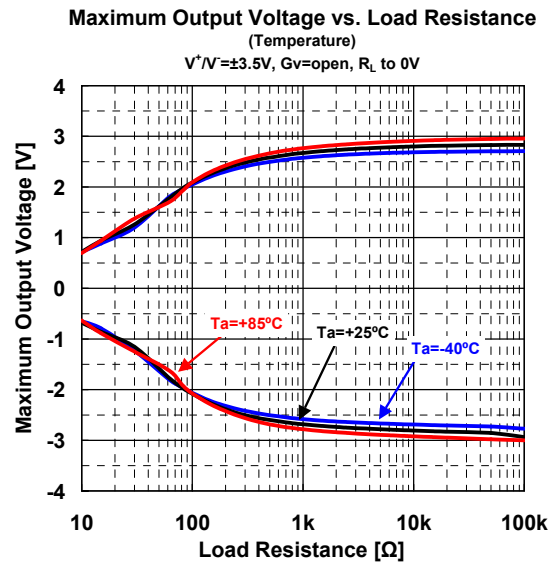
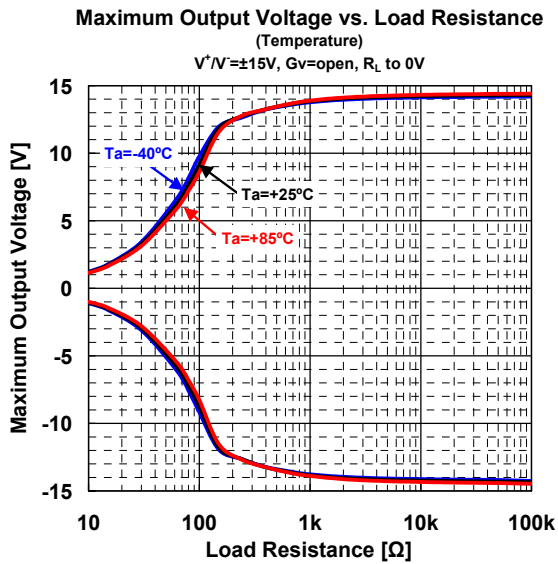
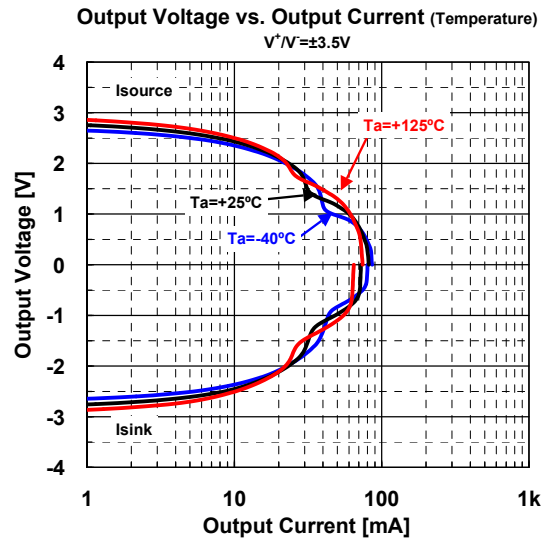
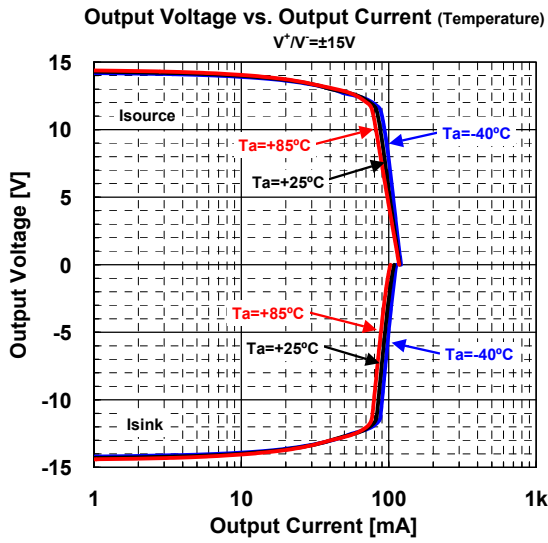

APPLICATION CIRCUIT

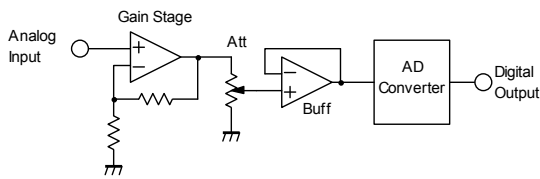

(Fig.1: ADC Input)

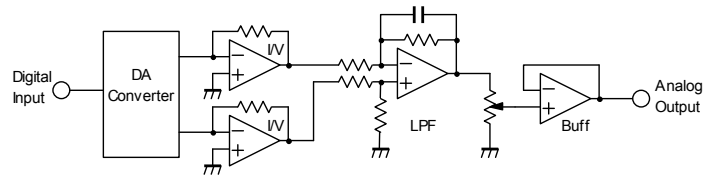

(Fig.2: DAC Output)

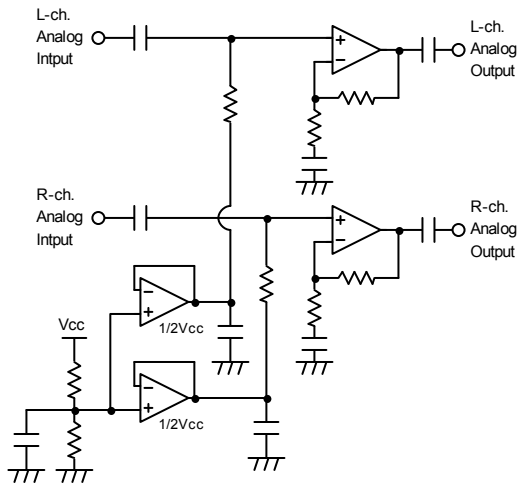

(Fig.3: Half Vcc Buffer on Single Supply Application)

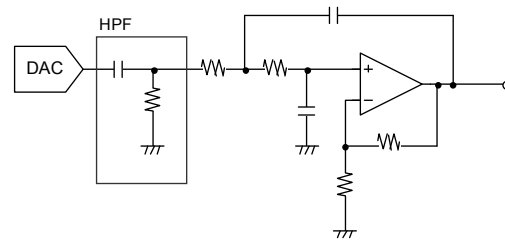

(Fig.4: DAC LPF Circuit)

NOTE

Precaution for counterfeit semiconductor products

We have recently detected many counterfeit semiconductor products that have very similar appearances to our operational amplifier "MUSES" in the world-wide market. In most cases, it is hard to distinguish them from our regular products by their appearance, and some of them have very poor quality and performance. They can not provide equivalent quality of our regular product, and they may cause breakdowns or malfunctions if used in your systems or applications.

We would like our customers to purchase "MUSES" through our official sales channels : our sales branches, sales subsidiaries and distributors.

Please note that we hold no responsibilities for any malfunctions or damages caused by using counterfeit products. We would appreciate your understanding.

<CAUTION>

The specifications on this data book are only given for information, without any guarantee as regards either mistakes or omissions. The application circuits in this data book are described only to show representative usages of the product and not intended for the guarantee or permission of any right including the industrial rights.