



PI7C9X110
PCI Express-to-PCI
Reversible Bridge
DATASHEET
Revision 6
October 2018



A Product Line of
Diodes Incorporated



1545 Barber Lane Milpitas, CA 95035
Telephone: 408-232-9100
FAX: 408-434-1040
Internet: <http://www.diodes.com>

IMPORTANT NOTICE

DIODES INCORPORATED MAKES NO WARRANTY OF ANY KIND, EXPRESS OR IMPLIED, WITH REGARDS TO THIS DOCUMENT, INCLUDING, BUT NOT LIMITED TO, THE IMPLIED WARRANTIES OF MERCHANTABILITY AND FITNESS FOR A PARTICULAR PURPOSE (AND THEIR EQUIVALENTS UNDER THE LAWS OF ANY JURISDICTION).

Diodes Incorporated and its subsidiaries reserve the right to make modifications, enhancements, improvements, corrections or other changes without further notice to this document and any product described herein. Diodes Incorporated does not assume any liability arising out of the application or use of this document or any product described herein; neither does Diodes Incorporated convey any license under its patent or trademark rights, nor the rights of others. Any Customer or user of this document or products described herein in such applications shall assume all risks of such use and will agree to hold Diodes Incorporated and all the companies whose products are represented on Diodes Incorporated website, harmless against all damages.

Diodes Incorporated does not warrant or accept any liability whatsoever in respect of any products purchased through unauthorized sales channel.

Should Customers purchase or use Diodes Incorporated products for any unintended or unauthorized application, Customers shall indemnify and hold Diodes Incorporated and its representatives harmless against all claims, damages, expenses, and attorney fees arising out of, directly or indirectly, any claim of personal injury or death associated with such unintended or unauthorized application.

Products described herein may be covered by one or more United States, international or foreign patents pending. Product names and markings noted herein may also be covered by one or more United States, international or foreign trademarks.

This document is written in English but may be translated into multiple languages for reference. Only the English version of this document is the final and determinative format released by Diodes Incorporated.

LIFE SUPPORT

Diodes Incorporated products are specifically not authorized for use as critical components in life support devices or systems without the express written approval of the Chief Executive Officer of Diodes Incorporated. As used herein:

A. Life support devices or systems are devices or systems which:

1. are intended to implant into the body, or
2. support or sustain life and whose failure to perform when properly used in accordance with instructions for use provided in the labeling can be reasonably expected to result in significant injury to the user.

B. A critical component is any component in a life support device or system whose failure to perform can be reasonably expected to cause the failure of the life support device or to affect its safety or effectiveness.

Customers represent that they have all necessary expertise in the safety and regulatory ramifications of their life support devices or systems, and acknowledge and agree that they are solely responsible for all legal, regulatory and safety-related requirements concerning their products and any use of Diodes Incorporated products in such safety-critical, life support devices or systems, notwithstanding any devices- or systems-related information or support that may be provided by Diodes Incorporated. Further, Customers must fully indemnify Diodes Incorporated and its representatives against any damages arising out of the use of Diodes Incorporated products in such safety-critical, life support devices or systems.

Copyright © 2016, Diodes Incorporated

www.diodes.com

REVISION HISTORY

DATE	REVISION #	DESCRIPTION
09/08/2006	2.0	First release of 9X110 datasheet without revision suffix
11/21/2006	2.1	Removed references to PI7C9X110A
03/06/2007	2.2	Revised ESD ratings in “DC Specifications” section 16.2
05/02/2007	2.3	Revised table 8-1 in section 8 Address bit[5] corrected to equal 0 Address bit[4] corrected to equal GPIO[3]
11/02/2007	2.4	Revised logos and font types and added Industrial Temp Compliancy
01/03/2008	2.5	Revised Industrial Temp Compliancy
05/16/2008	2.6	Revised Minimum PCI Frequency Support to 10MHz Added Leaded Part Number – PI7C9X110BNB
09/25/2008	2.6	Added additional pin description to GPIO [3:0]
08/21/2009	2.7	Revised Ordering Info Section for Leaded Part
09/14/2009	2.8	Revised Revision ID Register definition
10/10/2009	2.9	Updated the pin description of PCI Express Signals
04/28/2010	3.0	PCIX Feature is removed from Datasheets
03/22/2011	3.1	Updated Section 17 Package Information
04/27/2011	3.2	Updated Section 1 Introduction Updated Section 2.2 PCI Express Signals
12/07/2011	3.3	Updated Section 7.4.38 Express Transmitter/Receiver Register – Offset 68H (bit[5:2]) Updated Section 7.5.41 Express Transmitter/Receiver Register – Offset 68H (bit[5:2])
02/16/2015	4.0	Updated Section 7.4 PCI Configuration Registers For Transparent Bridge Mode Updated Section 7.5 PCI Configuration Registers For Non-Transparent Bridge Mode
04/15/2015	4.1	Updated Section 7.4 PCI Configuration Registers For Transparent Bridge Mode Updated Section 7.5 PCI Configuration Registers For Non-Transparent Bridge Mode
04/21/2016	4.2	Updated Section 2.5 JTAG Boundary Scan Signals
05/12/2017	4.3	Updated Section 16.1 Absolute Maximum ratings Updated Table 16-2 DC Electrical Characteristics Added Table 16-4 PCI Express Interface - Differential Transmitter (TX) Output Characteristics Added Table 16-5 PCI Express Interface - Differential Receiver (RX) Input Characteristics Added Section 16.4 Operating Ambient Temperature Added Table 16-4 PCIe Reference Clock Timing Parameters
09/27/2017	5	Added Section 16 Power Sequencing Updated Section 19 Ordering Information Revision numbering system changed to whole number
10/16/2018	6	Updated Section 19 Ordering Information Updated Section 1.3 General Features Added Figure 18-2 Part Marking

PREFACE

The datasheet of PI7C9X110 will be enhanced periodically when updated information is available. The technical information in this datasheet is subject to change without notice. This document describes the functionalities of PI7C9X110 (PCI Express Bridge) and provides technical information for designers to design their hardware using PI7C9X110.

TABLE OF CONTENTS

1	INTRODUCTION	14
1.1	PCI EXPRESS FEATURES	14
1.2	PCI FEATURES	15
1.3	GENERAL FEATURES.....	15
2	PIN DEFINITIONS	16
2.1	SIGNAL TYPES.....	16
2.2	PCI EXPRESS SIGNALS	16
2.3	PCI SIGNALS	16
2.4	MODE SELECT AND STRAPPING SIGNALS	18
2.5	JTAG BOUNDARY SCAN SIGNALS	18
2.6	MISCELLANEOUS SIGNALS	18
2.7	POWER AND GROUND PINS	19
2.8	PIN ASSIGNMENTS	19
3	MODE SELECTION AND PIN STRAPPING.....	21
3.1	FUNCTIONAL MODE SELECTION.....	21
3.2	PIN STRAPPING	21
4	FORWARD AND REVERSE BRIDGING.....	22
5	TRANSPARENT AND NON-TRANSPARENT BRIDGING.....	24
5.1	TRANSPARENT MODE.....	24
5.2	NON-TRANSPARENT MODE.....	24
6	PCI EXPRESS FUNCTIONAL OVERVIEW	26
6.1	TLP STRUCTURE	26
6.2	VIRTUAL ISOCHRONOUS OPERATION	26
7	CONFIGURATION REGISTERS.....	27
7.1	CONFIGURATION REGISTER MAP.....	27
7.2	PCI EXPRESS EXTENDED CAPABILITY REGISTER MAP	30
7.3	CONTROL AND STATUS REGISTER MAP.....	31
7.4	PCI CONFIGURATION REGISTERS FOR TRANSPARENT BRIDGE MODE.....	33
7.4.1	VENDOR ID – OFFSET 00h.....	33
7.4.2	DEVICE ID – OFFSET 00h.....	33
7.4.3	COMMAND REGISTER – OFFSET 04h.....	33
7.4.4	PRIMARY STATUS REGISTER – OFFSET 04h.....	34
7.4.5	REVISION ID REGISTER – OFFSET 08h.....	35
7.4.6	CLASS CODE REGISTER – OFFSET 08h.....	35
7.4.7	CACHE LINE SIZE REGISTER – OFFSET 0Ch.....	36
7.4.8	PRIMARY LATENCY TIMER REGISTER – OFFSET 0Ch	36
7.4.9	PRIMARY HEADER TYPE REGISTER – OFFSET 0Ch.....	36
7.4.10	RESERVED REGISTERS – OFFSET 10h TO 17h.....	36
7.4.11	PRIMARY BUS NUMBER REGISTER – OFFSET 18h.....	36
7.4.12	SECONDARY BUS NUMBER REGISTER – OFFSET 18h.....	36

7.4.13	SUBORDINATE BUS NUMBER REGISTER – OFFSET 18h.....	36
7.4.14	SECONDARY LATENCY TIME REGISTER – OFFSET 18h.....	37
7.4.15	I/O BASE REGISTER – OFFSET 1Ch.....	37
7.4.16	I/O LIMIT REGISTER – OFFSET 1Ch.....	37
7.4.17	SECONDARY STATUS REGISTER – OFFSET 1Ch.....	37
7.4.18	MEMORY BASE REGISTER – OFFSET 20h.....	38
7.4.19	MEMORY LIMIT REGISTER – OFFSET 20h.....	38
7.4.20	PREFETCHABLE MEMORY BASE REGISTER – OFFSET 24h.....	38
7.4.21	PREFETCHABLE MEMORY LIMIT REGISTER – OFFSET 24h.....	39
7.4.22	PREFETCHABLE BASE UPPER 32-BIT REGISTER – OFFSET 28h.....	39
7.4.23	PREFETCHABLE LIMIT UPPER 32-BIT REGISTER – OFFSET 2Ch.....	39
7.4.24	I/O BASE UPPER 16-BIT REGISTER – OFFSET 30h.....	39
7.4.25	I/O LIMIT UPPER 16-BIT REGISTER – OFFSET 30h.....	39
7.4.26	CAPABILITY POINTER – OFFSET 34h.....	39
7.4.27	EXPANSION ROM BASE ADDRESS REGISTER – OFFSET 38h.....	39
7.4.28	INTERRUPT LINE REGISTER – OFFSET 3Ch.....	40
7.4.29	INTERRUPT PIN REGISTER – OFFSET 3Ch.....	40
7.4.30	BRIDGE CONTROL REGISTER – OFFSET 3Ch.....	40
7.4.31	PCI DATA BUFFERING CONTROL REGISTER – OFFSET 40h.....	41
7.4.32	CHIP CONTROL 0 REGISTER – OFFSET 40h.....	43
7.4.33	RESERVED REGISTER – OFFSET 44h.....	44
7.4.34	ARBITER ENABLE REGISTER – OFFSET 48h.....	44
7.4.35	ARBITER MODE REGISTER – OFFSET 48h.....	44
7.4.36	ARBITER PRIORITY REGISTER – OFFSET 48h.....	45
7.4.37	RESERVED REGISTERS – OFFSET 4Ch – 64h.....	46
7.4.38	EXPRESS TRANSMITTER/RECEIVER REGISTER – OFFSET 68h.....	46
7.4.39	UPSTREAM MEMORY WRITE FRAGMENT CONTROL REGISTER – OFFSET 68h.....	47
7.4.40	RESERVED REGISTER – OFFSET 6Ch.....	47
7.4.41	EEPROM AUTOLOAD CONTROL/STATUS REGISTER – OFFSET 70h.....	47
7.4.42	RESERVED REGISTER – OFFSET 74h.....	48
7.4.43	GPIO DATA AND CONTROL REGISTER – OFFSET 78h.....	48
7.4.44	RESERVED REGISTER – OFFSET 7Ch.....	48
7.4.45	CAPABILITY ID REGISTER – OFFSET 80h.....	48
7.4.46	NEXT CAPABILITY POINTER REGISTER – OFFSET 80h.....	48
7.4.47	SECONDARY STATUS REGISTER – OFFSET 80h.....	48
7.4.48	BRIDGE STATUS REGISTER – OFFSET 84h.....	49
7.4.49	UPSTREAM SPLIT TRANSACTION REGISTER – OFFSET 88h.....	50
7.4.50	DOWNSTREAM SPLIT TRANSACTION REGISTER – OFFSET 8Ch.....	50
7.4.51	POWER MANAGEMENT ID REGISTER – OFFSET 90h.....	51
7.4.52	NEXT CAPABILITY POINTER REGISTER – OFFSET 90h.....	51
7.4.53	POWER MANAGEMENT CAPABILITY REGISTER – OFFSET 90h.....	51
7.4.54	POWER MANAGEMENT CONTROL AND STATUS REGISTER – OFFSET 94h.....	52
7.4.55	PCI-TO-PCI SUPPORT EXTENSION REGISTER – OFFSET 94h.....	52
7.4.56	RESERVED REGISTERS – OFFSET 98h – 9Ch.....	52
7.4.57	CAPABILITY ID REGISTER – OFFSET A0h.....	52
7.4.58	NEXT POINTER REGISTER – OFFSET A0h.....	52
7.4.59	SLOT NUMBER REGISTER – OFFSET A0h.....	53
7.4.60	CHASSIS NUMBER REGISTER – OFFSET A0h.....	53
7.4.61	SECONDARY CLOCK AND CLKRUN CONTROL REGISTER – OFFSET A4h.....	53
7.4.62	CAPABILITY ID REGISTER – OFFSET A8h.....	54
7.4.63	NEXT POINTER REGISTER – OFFSET A8h.....	54
7.4.64	RESERVED REGISTER – OFFSET A8h.....	54
7.4.65	SUBSYSTEM VENDOR ID REGISTER – OFFSET ACh.....	55
7.4.66	SUBSYSTEM ID REGISTER – OFFSET ACh.....	55

7.4.67	PCI EXPRESS CAPABILITY ID REGISTER – OFFSET B0h	55
7.4.68	NEXT CAPABILITY POINTER REGISTER – OFFSET B0h	55
7.4.69	PCI EXPRESS CAPABILITY REGISTER – OFFSET B0h	55
7.4.70	DEVICE CAPABILITY REGISTER – OFFSET B4h	55
7.4.71	DEVICE CONTROL REGISTER – OFFSET B8h	56
7.4.72	DEVICE STATUS REGISTER – OFFSET B8h	57
7.4.73	LINK CAPABILITY REGISTER – OFFSET BCh	57
7.4.74	LINK CONTROL REGISTER – OFFSET C0h	58
7.4.75	LINK STATUS REGISTER – OFFSET C0h	58
7.4.76	SLOT CAPABILITY REGISTER – OFFSET C4h	59
7.4.77	SLOT CONTROL REGISTER – OFFSET C8h	59
7.4.78	SLOT STATUS REGISTER – OFFSET C8h	60
7.4.79	XPIP CONFIGURATION REGISTER 0 – OFFSET CCh	60
7.4.80	XPIP CONFIGURATION REGISTER 1 – OFFSET D0h	60
7.4.81	XPIP CONFIGURATION REGISTER 2 – OFFSET D4h	60
7.4.82	HOT SWAP SWITCH DEBOUNCE COUNTER – OFFSET D4h	61
7.4.83	CAPABILITY ID REGISTER – OFFSET D8h	61
7.4.84	NEXT POINTER REGISTER – OFFSET D8h	61
7.4.85	VPD REGISTER – OFFSET D8h	61
7.4.86	VPD DATA REGISTER – OFFSET DCh	61
7.4.87	RESERVED REGISTERS – OFFSET E0h – ECh	61
7.4.88	MESSAGE SIGNED INTERRUPTS ID REGISTER – F0h	62
7.4.89	NEXT CAPABILITIES POINTER REGISTER – F0h	62
7.4.90	MESSAGE CONTROL REGISTER – OFFSET F0h	62
7.4.91	MESSAGE ADDRESS REGISTER – OFFSET F4h	62
7.4.92	MESSAGE UPPER ADDRESS REGISTER – OFFSET F8h	62
7.4.93	MESSAGE DATA REGISTER – OFFSET FCh	62
7.4.94	ADVANCE ERROR REPORTING CAPABILITY ID REGISTER – OFFSET 100h	63
7.4.95	ADVANCE ERROR REPORTING CAPABILITY VERSION REGISTER – OFFSET 100h	63
7.4.96	NEXT CAPABILITY OFFSET REGISTER – OFFSET 100h	63
7.4.97	UNCORRECTABLE ERROR STATUS REGISTER – OFFSET 104h	63
7.4.98	UNCORRECTABLE ERROR MASK REGISTER – OFFSET 108h	63
7.4.99	UNCORRECTABLE ERROR SEVERITY REGISTER – OFFSET 10Ch	64
7.4.100	CORRECTABLE ERROR STATUS REGISTER – OFFSET 110h	64
7.4.101	CORRECTABLE ERROR MASK REGISTER – OFFSET 114h	64
7.4.102	ADVANCED ERROR CAPABILITIES AND CONTROL REGISTER – OFFSET 118h	64
7.4.103	HEADER LOG REGISTER 1 – OFFSET 11Ch	65
7.4.104	HEADER LOG REGISTER 2 – OFFSET 120h	65
7.4.105	HEADER LOG REGISTER 3 – OFFSET 124h	65
7.4.106	HEADER LOG REGISTER 4 – OFFSET 128h	65
7.4.107	SECONDARY UNCORRECTABLE ERROR STATUS REGISTER – OFFSET 12Ch	65
7.4.108	SECONDARY UNCORRECTABLE ERROR MASK REGISTER – OFFSET 130h	66
7.4.109	SECONDARY UNCORRECTABLE ERROR SEVERITY REGISTER – OFFSET 134h	66
7.4.110	SECONDARY ERROR CAPABILITY AND CONTROL REGISTER – OFFSET 138h	67
7.4.111	SECONDARY HEADER LOG REGISTER – OFFSET 13Ch – 148h	67
7.4.112	RESERVED REGISTER – OFFSET 14Ch	67
7.4.113	VC CAPABILITY ID REGISTER – OFFSET 150h	67
7.4.114	VC CAPABILITY VERSION REGISTER – OFFSET 150h	67
7.4.115	NEXT CAPABILITY OFFSET REGISTER – OFFSET 150h	67
7.4.116	PORT VC CAPABILITY REGISTER 1 – OFFSET 154h	68
7.4.117	PORT VC CAPABILITY REGISTER 2 – OFFSET 158h	68
7.4.118	PORT VC CONTROL REGISTER – OFFSET 15Ch	68
7.4.119	PORT VC STATUS REGISTER – OFFSET 15Ch	68
7.4.120	VC0 RESOURCE CAPABILITY REGISTER – OFFSET 160h	68

7.4.121	VC0 RESOURCE CONTROL REGISTER – OFFSET 164h.....	68
7.4.122	VC0 RESOURCE STATUS REGISTER – OFFSET 168h.....	69
7.4.123	RESERVED REGISTERS – OFFSET 16Ch – 300h.....	69
7.4.124	EXTRA GPI/GPO DATA AND CONTROL REGISTER – OFFSET 304h.....	69
7.4.125	RESERVED REGISTERS – OFFSET 308h – 30Ch.....	69
7.4.126	REPLAY AND ACKNOWLEDGE LATENCY TIMERS – OFFSET 310h.....	69
7.4.127	RESERVED REGISTERS – OFFSET 314h – FFCh.....	69
7.5	PCI CONFIGURATION REGISTERS FOR NON-TRANSPARENT BRIDGE MODE.....	70
7.5.1	VENDOR ID – OFFSET 00h.....	70
7.5.2	DEVICE ID – OFFSET 00h.....	70
7.5.3	COMMAND REGISTER – OFFSET 04h.....	70
7.5.4	PRIMARY STATUS REGISTER – OFFSET 04h.....	71
7.5.5	REVISION ID REGISTER – OFFSET 08h.....	72
7.5.6	CLASS CODE REGISTER – OFFSET 08h.....	72
7.5.7	CACHE LINE SIZE REGISTER – OFFSET 0Ch.....	73
7.5.8	PRIMARY LATENCY TIMER REGISTER – OFFSET 0Ch.....	73
7.5.9	PRIMARY HEADER TYPE REGISTER – OFFSET 0Ch.....	73
7.5.10	PRIMARY CSR AND MEMORY 0 BASE ADDRESS REGISTER – OFFSET 10h.....	73
7.5.11	PRIMARY CSR I/O BASE ADDRESS REGISTER – OFFSET 14h.....	74
7.5.12	DOWNSTREAM I/O OR MEMORY 1 BASE ADDRESS REGISTER – OFFSET 18h.....	74
7.5.13	DONWSTREAM MEMORY 2 BASE ADDRESS REGISTER – OFFSET 1Ch.....	74
7.5.14	DOWNSTREAM MEMORY 3 BASE ADDRESS REGISTER – OFFSET 20h.....	75
7.5.15	DOWNSTREAM MEMORY 3 UPPER BASE ADDRESS REGISTER – OFFSET 24h.....	75
7.5.16	RESERVED REGISTER – OFFSET 28h.....	76
7.5.17	SUBSYSTEM ID AND SUBSYSTEM VENDOR ID REGISTER – OFFSET 2Ch.....	76
7.5.18	RESERVED REGISTER – OFFSET 30h.....	76
7.5.19	CAPABILITY POINTER – OFFSET 34h.....	76
7.5.20	EXPANSION ROM BASE ADDRESS REGISTER – OFFSET 38h.....	76
7.5.21	PRIMARY INTERRUPT LINE REGISTER – OFFSET 3Ch.....	76
7.5.22	PRIMARY INTERRUPT PIN REGISTER – OFFSET 3Ch.....	76
7.5.23	PRIMARY MINIMUM GRANT REGISTER – OFFSET 3Ch.....	76
7.5.24	PRIMARY MAXIMUM LATENCY TIME REGISTER – OFFSET 3Ch.....	77
7.5.25	PCI DATA BUFFERING CONTROL REGISTER – OFFSET 40h.....	77
7.5.26	CHIP CONTROL 0 REGISTER – OFFSET 40h.....	78
7.5.27	SECONDARY COMMAND REGISTER – OFFSET 44h.....	79
7.5.28	SECONDARY STATUS REGISTER – OFFSET 44h.....	80
7.5.29	ARBITER ENABLE REGISTER – OFFSET 48h.....	81
7.5.30	ARBITER MODE REGISTER – OFFSET 48h.....	82
7.5.31	ARBITER PRIORITY REGISTER – OFFSET 48h.....	83
7.5.32	SECONDARY CACHE LINE SIZE REGISTER – OFFSET 4Ch.....	83
7.5.33	SECONDARY LATENCY TIME REGISTER – OFFSET 4Ch.....	84
7.5.34	SECONDARY HEADER TYPE REGISTER – OFFSET 4Ch.....	84
7.5.35	SECONDARY CSR AND MEMORY 0 BASE ADDRESS REGISTER – OFFSET 50h.....	84
7.5.36	SECONDARY CSR I/O BASE ADDRESS REGISTER – OFFSET 54h.....	85
7.5.37	UPSTREAM I/O OR MEMORY 1 BASE ADDRESS REGISTER – OFFSET 58h.....	85
7.5.38	UPSTREAM MEMORY 2 BASE ADDRESS REGISTER – OFFSET 5Ch.....	85
7.5.39	UPSTREAM MEMORY 3 BASE ADDRESS REGISTER – OFFSET 60h.....	86
7.5.40	UPSTREAM MEMORY 3 UPPER BASE ADDRESS REGISTER – OFFSET 64h.....	86
7.5.41	EXPRESS TRANSMITTER/RECEIVER REGISTER – OFFSET 68h.....	87
7.5.42	MEMORY ADDRESS FORWARDING CONTROL REGISTER – OFFSET 68h.....	88
7.5.43	UPSTREAM MEMORY WRITE FRAGMENT CONTROL REGISTER – OFFSET 68h.....	88
7.5.44	SUBSYSTEM VENDOR ID REGISTER – OFFSET 6Ch.....	88
7.5.45	SUBSYSTEM ID REGISTER – OFFSET 6Ch.....	89
7.5.46	EEPROM AUTOLOAD CONTROL/STATUS REGISTER – OFFSET 70h.....	89

7.5.47	RESERVED REGISTER – OFFSET 74h.....	89
7.5.48	BRIDGE CONTROL AND STATUS REGISTER – OFFSET 78h.....	89
7.5.49	GPIO DATA AND CONTROL REGISTER – OFFSET 78h.....	90
7.5.50	SECONDARY INTERRUPT LINE REGISTER – OFFSET 7Ch.....	91
7.5.51	SECONDARY INTERRUPT PIN REGISTER – OFFSET 7Ch.....	91
7.5.52	SECONDARY MINIMUM GRANT REGISTER – OFFSET 7Ch.....	91
7.5.53	SECONDARY MAXIMUM LATENCY TIMER REGISTER – OFFSET 7Ch.....	91
7.5.54	CAPABILITY ID REGISTER – OFFSET 80h.....	91
7.5.55	NEXT CAPABILITY POINTER REGISTER – OFFSET 80h.....	91
7.5.56	SECONDARY STATUS REGISTER – OFFSET 80h.....	91
7.5.57	BRIDGE STATUS REGISTER – OFFSET 84h.....	92
7.5.58	UPSTREAM SPLIT TRANSACTION REGISTER – OFFSET 88h.....	93
7.5.59	DOWNSTREAM SPLIT TRANSACTION REGISTER – OFFSET 8Ch.....	94
7.5.60	POWER MANAGEMENT ID REGISTER – OFFSET 90h.....	94
7.5.61	NEXT CAPABILITY POINTER REGISTER – OFFSET 90h.....	94
7.5.62	POWER MANAGEMENT CAPABILITY REGISTER – OFFSET 90h.....	94
7.5.63	POWER MANAGEMENT CONTROL AND STATUS REGISTER – OFFSET 94h.....	95
7.5.64	PCI-TO-PCI SUPPORT EXTENSION REGISTER – OFFSET 94h.....	95
7.5.65	DOWNSTREAM MEMORY 0 TRANSLATED BASE REGISTER – OFFSET 98h.....	95
7.5.66	DOWNSTREAM MEMORY 0 SETUP REGISTER – OFFSET 9Ch.....	96
7.5.67	CAPABILITY ID REGISTER – OFFSET A0h.....	96
7.5.68	NEXT POINTER REGISTER – OFFSET A0h.....	96
7.5.69	SLOT NUMBER REGISTER – OFFSET A0h.....	96
7.5.70	CHASSIS NUMBER REGISTER – OFFSET A0h.....	96
7.5.71	SECONDARY CLOCK AND CLKRUN CONTROL REGISTER – OFFSET A4h.....	97
7.5.72	DONWSTREAM I/O OR MEMORY 1 TRANSLATED BASE REGISTER – OFFSET A8h.....	98
7.5.73	DOWSTREAM I/O OR MEMORY 1 SETUP REGISTER – OFFSET ACh.....	98
7.5.74	PCI EXPRESS CAPABILITY ID REGISTER – OFFSET B0h.....	98
7.5.75	NEXT CAPABILITY POINTER REGISTER – OFFSET B0h.....	99
7.5.76	PCI EXPRESS CAPABILITY REGISTER – OFFSET B0h.....	99
7.5.77	DEVICE CAPABILITY REGISTER – OFFSET B4h.....	99
7.5.78	DEVICE CONTROL REGISTER – OFFSET B8h.....	100
7.5.79	DEVICE STATUS REGISTER – OFFSET B8h.....	101
7.5.80	LINK CAPABILITY REGISTER – OFFSET BCh.....	101
7.5.81	LINK CONTROL REGISTER – OFFSET C0h.....	102
7.5.82	LINK STATUS REGISTER – OFFSET C0h.....	102
7.5.83	SLOT CAPABILITY REGISTER – OFFSET C4h.....	102
7.5.84	SLOT CONTROL REGISTER – OFFSET C8h.....	103
7.5.85	SLOT STATUS REGISTER – OFFSET C8h.....	103
7.5.86	XPIP CONFIGURATION REGISTER 0 – OFFSET CCh.....	103
7.5.87	XPIP CONFIGURATION REGISTER 1 – OFFSET D0h.....	104
7.5.88	XPIP CONFIGURATION REGISTER 2 – OFFSET D4h.....	104
7.5.89	CAPABILITY ID REGISTER – OFFSET D8h.....	104
7.5.90	NEXT POINTER REGISTER – OFFSET D8h.....	104
7.5.91	VPD REGISTER – OFFSET D8h.....	104
7.5.92	VPD DATA REGISTER – OFFSET DCh.....	105
7.5.93	UPSTREAM MEMORY 0 TRANSLATED BASE REGISTER – OFFSET E0h.....	105
7.5.94	UPSTREAM MEMORY 0 SETUP REGISTER – OFFSET E4h.....	105
7.5.95	UPSTREAM I/O OR MEMORY 1 TRANSLATED BASE REGISTER – OFFSET E8h.....	105
7.5.96	UPSTREAM I/O OR MEMORY 1 SETUP REGISTER – OFFSET Ech.....	106
7.5.97	MESSAGE SIGNED INTERRUPTS ID REGISTER – F0h.....	106
7.5.98	NEXT CAPABILITIES POINTER REGISTER – F0h.....	106
7.5.99	MESSAGE CONTROL REGISTER – OFFSET F0h.....	106
7.5.100	MESSAGE ADDRESS REGISTER – OFFSET F4h.....	107

7.5.101	MESSAGE UPPER ADDRESS REGISTER – OFFSET F8h.....	107
7.5.102	MESSAGE DATA REGISTER – OFFSET FCh.....	107
7.5.103	ADVANCE ERROR REPORTING CAPABILITY ID REGISTER – OFFSET 100h.....	107
7.5.104	ADVANCE ERROR REPORTING CAPABILITY VERSION REGISTER – OFFSET 100h.....	107
7.5.105	NEXT CAPABILITY OFFSET REGISTER – OFFSET 100h.....	107
7.5.106	UNCORRECTABLE ERROR STATUS REGISTER – OFFSET 104h.....	107
7.5.107	UNCORRECTABLE ERROR MASK REGISTER – OFFSET 108h.....	108
7.5.108	UNCORRECTABLE ERROR SEVERITY REGISTER – OFFSET 10Ch.....	108
7.5.109	CORRECTABLE ERROR STATUS REGISTER – OFFSET 110h.....	109
7.5.110	CORRECTABLE ERROR MASK REGISTER – OFFSET 114h.....	109
7.5.111	ADVANCED ERROR CAPABILITIES AND CONTROL REGISTER – OFFSET 118h.....	109
7.5.112	HEADER LOG REGISTER 1 – OFFSET 11Ch.....	109
7.5.113	HEADER LOG REGISTER 2 – OFFSET 120h.....	109
7.5.114	HEADER LOG REGISTER 3 – OFFSET 124h.....	109
7.5.115	HEADER LOG REGISTER 4 – OFFSET 128h.....	110
7.5.116	SECONDARY UNCORRECTABLE ERROR STATUS REGISTER – OFFSET 12Ch.....	110
7.5.117	SECONDARY UNCORRECTABLE ERROR MASK REGISTER – OFFSET 130h.....	110
7.5.118	SECONDARY UNCORRECTABLE ERROR SEVERITY REGISTER – OFFSET 134h.....	111
7.5.119	SECONDARY ERROR CAPABILITY AND CONTROL REGISTER – OFFSET 138h.....	111
7.5.120	SECONDARY HEADER LOG REGISTER – OFFSET 13Ch – 148h.....	111
7.5.121	RESERVED REGISTER – OFFSET 14Ch.....	112
7.5.122	VC CAPABILITY ID REGISTER – OFFSET 150h.....	112
7.5.123	VC CAPABILITY VERSION REGISTER – OFFSET 150h.....	112
7.5.124	NEXT CAPABILITY OFFSET REGISTER – OFFSET 150h.....	112
7.5.125	PORT VC CAPABILITY REGISTER 1 – OFFSET 154h.....	112
7.5.126	PORT VC CAPABILITY REGISTER 2 – OFFSET 158h.....	112
7.5.127	PORT VC CONTROL REGISTER – OFFSET 15Ch.....	112
7.5.128	PORT VC STATUS REGISTER – OFFSET 15Ch.....	113
7.5.129	VC0 RESOURCE CAPABILITY REGISTER – OFFSET 160h.....	113
7.5.130	VC0 RESOURCE CONTROL REGISTER – OFFSET 164h.....	113
7.5.131	VC0 RESOURCE STATUS REGISTER – OFFSET 168h.....	113
7.5.132	RESERVED REGISTERS – OFFSET 16Ch – 300h.....	113
7.5.133	EXTRA GPI/GPO DATA AND CONTROL REGISTER – OFFSET 304h.....	113
7.5.134	RESERVED REGISTERS – OFFSET 308h – 30Ch.....	113
7.5.135	REPLAY AND ACKNOWLEDGE LATENCY TIMERS – OFFSET 310h.....	114
7.5.136	RESERVED REGISTERS – OFFSET 314h – FFCh.....	114
7.6	CONTROL AND STATUS REGISTERS FOR NON-TRANSPARENT BRIDGE MODE	115
7.6.1	RESERVED REGISTERS – OFFSET 000h TO 004h.....	115
7.6.2	DOWNSTREAM MEMORY 2 TRANSLATED BASE REGISTER – OFFSET 008h.....	115
7.6.3	DOWNSTREAM MEMORY 2 SETUP REGISTER – OFFSET 00Ch.....	115
7.6.4	DOWNSTREAM MEMORY 3 TRANSLATED BASE REGISTER – OFFSET 010h.....	115
7.6.5	DOWNSTREAM MEMORY 3 SETUP REGISTER – OFFSET 014h.....	116
7.6.6	DOWNSTREAM MEMORY 3 UPPER 32-BIT SETUP REGISTER – OFFSET 018h.....	116
7.6.7	RESERVED REGISTERS – OFFSET 01Ch TO 030h.....	116
7.6.8	UPSTREAM MEMORY 3 SETUP REGISTER – OFFSET 34h.....	116
7.6.9	UPSTREAM MEMORY 3 UPPER 32-BIT SETUP REGISTER – OFFSET 038h.....	117
7.6.10	RESERVED REGISTERS – OFFSET 03Ch TO 04Ch.....	117
7.6.11	LOOKUP TABLE OFFSET – OFFSET 050h.....	117
7.6.12	LOOKUP TABLE DATA – OFFSET 054h.....	117
7.6.13	UPSTREAM PAGE BOUNDARY IRQ 0 REQUEST REGISTER – OFFSET 058h.....	118
7.6.14	UPSTREAM PAGE BOUNDARY IRQ 1 REQUEST REGISTER – OFFSET 05Ch.....	118
7.6.15	UPSTREAM PAGE BOUNDARY IRQ 0 MASK REGISTER – OFFSET 060h.....	119
7.6.16	UPSTREAM PAGE BOUNDARY IRQ 1 MASK REGISTER – OFFSET 064h.....	119
7.6.17	RESERVED REGISTER – OFFSET 068C.....	119

7.6.18	PRIMARY CLEAR IRQ REGISTER – OFFSET 070h.....	119
7.6.19	SECONDARY CLEAR IRQ REGISTER – OFFSET 070h.....	119
7.6.20	PRIMARY SET IRQ REGISTER – OFFSET 074h	120
7.6.21	SECONDARY SET IRQ REGISTER – OFFSET 074h	120
7.6.22	PRIMARY CLEAR IRQ MASK REGISTER – OFFSET 078h	120
7.6.23	SECONDARY CLEAR IRQ MASK REGISTER – OFFSET 078h	120
7.6.24	PRIMARY SET IRQ MASK REGISTER – OFFSET 07Ch	121
7.6.25	SECONDARY SET IRQ MASK REGISTER – OFFSET 07Ch	121
7.6.26	RESERVED REGISTERS – OFFSET 080h TO 09Ch.....	121
7.6.27	SCRATCHPAD 0 REGISTER – OFFSET 0A0h.....	121
7.6.28	SCRATCHPAD 1 REGISTER – OFFSET 0A4h.....	121
7.6.29	SCRATCHPAD 2 REGISTER – OFFSET 0A8h.....	122
7.6.30	SCRATCHPAD 3 REGISTER – OFFSET 0ACh.....	122
7.6.31	SCRATCHPAD 4 REGISTER – OFFSET 0B0h.....	122
7.6.32	SCRATCHPAD 5 REGISTER – OFFSET 0B4h.....	122
7.6.33	SCRATCHPAD 6 REGISTER – OFFSET 0B8h.....	122
7.6.34	SCRATCHPAD 7 REGISTER – OFFSET 0BCh.....	123
7.6.35	RESERVED REGISTERS – OFFSET 0C0h TO 0FCh.....	123
7.6.36	LOOKUP TABLE REGISTERS – OFFSET 100h TO 1FCh	123
7.6.37	RESERVED REGISTERS – OFFSET 200h TO FFCh.....	123
8	GPIO PINS AND SM BUS ADDRESS.....	124
9	CLOCK SCHEME	125
10	INTERRUPTS.....	126
11	EEPROM (I2C) INTERFACE AND SYSTEM MANAGEMENT BUS.....	127
11.1	EEPROM (I2C) INTERFACE.....	127
11.2	SYSTEM MANAGEMENT BUS	127
12	HOT PLUG OPERATION	128
13	RESET SCHEME.....	129
14	IEEE 1149.1 COMPATIBLE JTAG CONTROLLER	130
14.1	INSTRUCTION REGISTER.....	130
14.2	BYPASS REGISTER	130
14.3	DEVICE ID REGISTER.....	130
14.4	BOUNDARY SCAN REGISTER	131
14.5	JTAG BOUNDARY SCAN REGISTER ORDER	131
15	POWER MANAGEMENT	134
16	POWER SEQUENCING	135
16.1	INITIAL POWER-UP (G3 TO L0).....	136
17	ELECTRICAL AND TIMING SPECIFICATIONS.....	138
17.1	ABSOLUTE MAXIMUM RATINGS	138
17.2	DC SPECIFICATIONS	138
17.3	AC SPECIFICATIONS	139
17.4	OPERATING AMBIENT TEMPERATURE.....	140

18	PACKAGE INFORMATION.....	141
19	ORDERING INFORMATION.....	142

TABLE OF FIGURES

FIGURE 1-1 PI7C9X110 TOPOLOGY	14
FIGURE 4-1 FORWARD AND NON-TRANSPARENT BRIDGE MODE	22
FIGURE 4-2 REVERSE AND TRANSPARENT BRIDGE MODE	23
FIGURE 16-1 TIMING SEQUENCE WITH UNDETERMINED I/O STATE	135
FIGURE 16-2 RECOMMENDED POWER SEQUENCE	135
FIGURE 16-3 INITIAL POWER-UP	136
FIGURE 17-1 PCI SIGNAL TIMING CONDITIONS.....	139
FIGURE 18-1 PACKAGE OUTLINE DRAWING	141
FIGURE 18-2 PART MARKING	141

LIST OF TABLES

TABLE 2-1 PIN ASSIGNMENTS.....	19
TABLE 3-1 MODE SELECTION	21
TABLE 3-2 PIN STRAPPING.....	21
TABLE 5-1 NON-TRANSPARENT REGISTERS	25
TABLE 6-1 TLP FORMAT	26
TABLE 7-1 CONFIGURATION REGISTER MAP (00H – FFH)	27
TABLE 7-2 PCI EXPRESS EXTENDED CAPABILITY REGISTER MAP (100H – FFFH)	30
TABLE 7-3 CONTROL AND STATUS REGISTER (CSR) MAP (000H – FFFH)	31
TABLE 8-1 SM BUS DEVICE ID STRAPPING	124
TABLE 10-1 PCIe INTERRUPT MESSAGE TO PCI INTERRUPT MAPPING IN REVERSE BRIDGE MODE.....	126
TABLE 10-2 PCI INTERRUPT TO PCIe INTERRUPT MESSAGE MAPPING IN FORWARD BRIDGE MODE	126
TABLE 14-1 INSTRUCTION REGISTER CODES	130
TABLE 14-2 JTAG DEVICE ID REGISTER.....	130
TABLE 14-3 JTAG BOUNDARY SCAR REGISTER DEFINITION	131
TABLE 16-1 POWER SEQUENCING AND RESET SIGNAL TIMINGS.....	137
TABLE 17-1 ABSOLUTE MAXIMUM RATINGS	138
TABLE 17-2 DC ELECTRICAL CHARACTERISTICS	138
TABLE 17-3 PCI BUS TIMING PARAMETERS	139
TABLE 17-4 PCIe REFERENCE CLOCK TIMING PARAMETERS	139
TABLE 17-5 PCI EXPRESS INTERFACE - DIFFERENTIAL TRANSMITTER (TX) OUTPUT CHARACTERISTICS	139
TABLE 17-6 PCI EXPRESS INTERFACE - DIFFERENTIAL RECEIVER (RX) INPUT CHARACTERISTICS	140
TABLE 17-7 OPERATING AMBIENT TEMPERATURE	140

This page intentionally left blank.

1 INTRODUCTION

PI7C9X110 is a PCIe-to-PCI bridge. PI7C9X110 is compliant with the *PCI Express Base Specification*, Revision 1.0a, the *PCI Express Card Electromechanical Specification*, Revision 1.0a, the *PCI Local Bus Specification*, Revision 3.0 and *PCI Express to PCI Bridge Specification*, Revision 1.0. PI7C9X110 supports transparent and non-transparent mode of operations. Also, PI7C9X110B supports forward and reverse bridging. In forward bridge mode, PI7C9X110 has an x1 PCI Express upstream port and a 32-bit PCI downstream port. The 32-bit PCI downstream port is 66MHz capable (see figure 1-1). In reverse bridge mode, PI7C9X110 has a 32-bit PCI upstream port and an x1 PCI Express downstream port. PI7C9X110 configuration registers are backward compatible with existing PCI bridge software and firmware. No modification of PCI bridge software and firmware is needed for the original operation. The PCIe port of the PI7C9X110 bridge always has higher priority over the PCI ports if the configuration registers are accessed simultaneously via the PCIe and PCI ports.

Figure 1-1 PI7C9X110 Topology

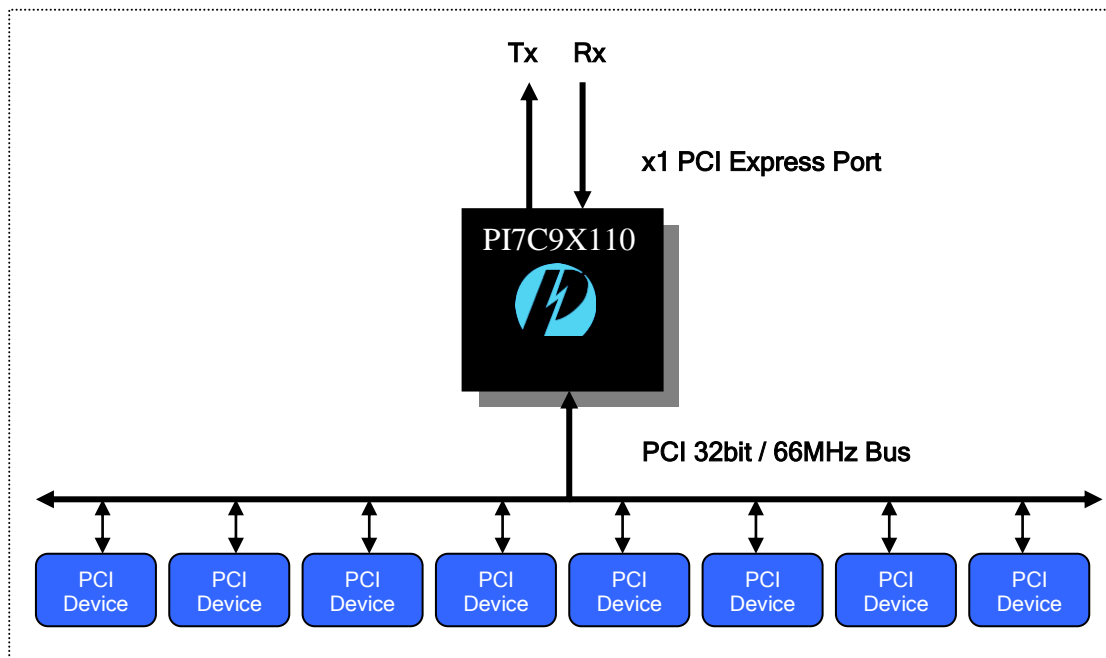

1.1 PCI EXPRESS FEATURES

- Compliant with PCI Express Base Specification, Revision 1.0a
- Compliant with PCI Express Card Electromechanical Specification, Revision 1.0a
- Compliant with PCI Express to PCI Bridge Specification, Revision 1.0
- Physical Layer interface (x1 link with 2.5Gb/s data rate)
- Lane polarity toggle
- Virtual Isochronous support (upstream TC1-7 generation, downstream TC1-7 mapping)
- ASPM support
- Beacon support
- CRC (16-bit), LCRC (32-bit)
- ECRC and advanced error reporting
- PRBS (Pseudo Random Bit Sequencing) generator/checker for chip testing

- Maximum payload size to 512 bytes

1.2 PCI FEATURES

- Compliant with PCI Local Bus Specification, Revision 3.0
- Compliant with PCI-to-PCI Bridge Architecture Specification, Revision 1.2
- Compliant with PCI Bus PM Interface Specification, Revision 1.1
- Compliant with PCI Hot-Plug Specification, Revision 1.1
- Compliant with PCI Mobile Design Guide, Version 1.1
- PME support
- 3.3V PCI signaling with 5V I/O tolerance
- Provides two level arbitration support for eight PCI Bus masters
- 16-bit address decode for VGA
- Subsystem Vendor and Subsystem Device IDs support
- Capable of supporting minimum PCI Frequency of 10MHz
- PCI INT interrupt or MSI Function support

1.3 GENERAL FEATURES

- Compliant with Advanced Configuration and Power Interface Specification (ACPI), Revision 2.0b
- Compliant with System Management (SM) Bus, Version 2.0
- Forward bridging (PCI Express as primary bus, PCI as secondary bus)
- Reverse bridging (PCI as primary bus, PCI Express as secondary bus)
- Transparent mode support
- Non-transparent mode Support
- GPIO support (4 bi-directional pins)
- Power Management (including ACPI, CLKRUN_L, PCI_PM)
- Masquerade Mode (pre-loadable vendor, device, and revision IDs)
- EEPROM (I2C) Interface
- SM Bus Interface
- Auxiliary powers (VAUX, VDDAUX, VDDCAUX) support
- Power consumption at about 1.0 Watt in typical condition
- Extended commercial/industrial temperature range (-40C to 85C)
- Totally Lead-Free & Fully RoHS Compliant (Notes 1 & 2)
- Halogen and Antimony Free. "Green" Device (Note 3)

Notes:

1. No purposely added lead. Fully EU Directive 2002/95/EC (RoHS), 2011/65/EU (RoHS 2) & 2015/863/EU (RoHS 3) compliant.
2. See <https://www.diodes.com/quality/lead-free/> for more information about Diodes Incorporated's definitions of Halogen- and Antimony-free, "Green" and Lead-free.
3. Halogen- and Antimony-free "Green" products are defined as those which contain <900ppm bromine, <900ppm chlorine (<1500ppm total Br + Cl) and <1000ppm antimony compounds.

2 PIN DEFINITIONS

2.1 SIGNAL TYPES

TYPE OF SIGNAL - DESCRIPTIONS	
B	Bi-directional
I	Input
IU	Input with pull-up
ID	Input with pull-down
IOD	Bi-directional with open drain output
OD	Open drain output
O	Output
P	Power
G	Ground

2.2 PCI EXPRESS SIGNALS

NAME	PIN ASSIGNMENT	TYPE	DESCRIPTION
REFCLKP REFCLKN	E3, E2	I	Reference Clock Inputs: Connect to external 100MHz differential clock. These signals require AC coupled with 0.1uF capacitors.
RP RN	G4, H4	I	PCI Express data inputs: Differential data receiver input signals
TP TN	G1, F1	O	PCI Express data outputs: Differential data transmitter output signals
RREF	H3	I	Resistor Reference: It is used to connect an external resistor (2.1K Ohm +/- 1%) to VSS to provide a reference current for the driver and equalization circuit.
PERST_L	L3	B	PCI Express Fundamental Reset: PI7C9X110B uses this reset to initialize the internal state machines.

2.3 PCI SIGNALS

NAME	PIN ASSIGNMENT	TYPE	DESCRIPTION
AD [31:0]	B3, A4, B4, D4, A5, C5, D5, B6, A7, B7, D7, A8, C8, D8, B9, C9, C12, D14, D12, D11, E13, F14, F13, F11, G12, G11, H13, H12, J14, J13, J11, K14	B	Address / Data: Multiplexed address and data bus. Address phase is aligned with first clock of FRAME_L assertion. Data phase is aligned with IRDY_L or TRDY_L assertion. Data is transferred on rising edges of FBCLKIN when both IRDY_L and TRDY_L are asserted. During bus idle (both FRAME_L and IRDY_L are de-asserted), PI7C9X110B drives AD to a valid logic level when arbiter is parking to PI7C9X110B on PCI bus.
CBE [3:0]	C6, A10, C14, G14	B	Command / Byte Enables (Active LOW): Multiplexed command at address phase and byte enable at data phase. During address phase, the initiator drives commands on CBE [3:0] signals to start the transaction. If the command is a write transaction, the initiator will drive the byte enables during data phase. Otherwise, the target will drive the byte enables during data phase. During bus idle, PI7C9X110B drives CBE [3:0] signals to a valid logic level when arbiter is parking to PI7C9X110B on PCI bus.
PAR	B13	B	Parity Bit: Parity bit is an even parity (i.e. even number of 1's), which generates based on the values of AD [31:0], CBE [3:0]. If PI7C9X110B is an initiator with a write transaction, PI7C9X110B will tri-state PAR. If PI7C9X110B is a target and a write transaction, PI7C9X110B will drive PAR one clock after the address or data phase. If PI7C9X110B is a target and a read transaction, PI7C9X110B will drive PAR one clock after the address phase and tri-state PAR during data phases. PAR is tri-stated one cycle after the AD lines are tri-stated. During bus idle, PI7C9X110B drives PAR to a valid logic level when arbiter is parking to PI7C9X110B on PCI bus.
FRAME_L	B10	B	FRAME (Active LOW): Driven by the initiator of a transaction to indicate the beginning and duration an access. The de-assertion of FRAME_L indicates the final data phase signaled by the initiator in burst transfers. Before being tri-stated, it is driven to a de-asserted state for one cycle.

NAME	PIN ASSIGNMENT	TYPE	DESCRIPTION
IRDY_L	D10	B	IRDY (Active LOW): Driven by the initiator of a transaction to indicate its ability to complete current data phase on the primary side. Once asserted in a data phase, it is not de-asserted until the end of the data phase. Before tri-stated, it is driven to a de-asserted state for one cycle.
TRDY_L	A11	B	TRDY (Active LOW): Driven by the target of a transaction to indicate its ability to complete current data phase on the primary side. Once asserted in a data phase, it is not de-asserted until the end of the data phase. Before tri-stated, it is driven to a de-asserted state for one cycle.
DEVSEL_L	B11	B	Device Select (Active LOW): Asserted by the target indicating that the device is accepting the transaction. As a master, PI7C9X110 waits for the assertion of this signal within 5 cycles of FRAME_L assertion; otherwise, terminate with master abort. Before tri-stated, it is driven to a de-asserted state for one cycle.
STOP_L	A12	B	STOP (Active LOW): Asserted by the target indicating that the target is requesting the initiator to stop the current transaction. Before tri-stated, it is driven to a de-asserted state for one cycle.
LOCK_L	A13	B	LOCK (Active LOW): Asserted by the initiator for multiple transactions to complete. PI7C9X110B does not support any upstream LOCK transaction.
IDSEL	N14	I	Initialization Device Select: Used as a chip select line for Type 0 configuration access to bridge's configuration space.
PERR_L	A14	B	Parity Error (Active LOW): Asserted when a data parity error is detected for data received on the PCI bus interface. Before being tri-stated, it is driven to a de-asserted state for one cycle.
SERR_L	B14	IOD	System Error (Active LOW): Can be driven LOW by any device to indicate a system error condition. If SERR control is enabled, PI7C9X110B will drive this pin on: <ul style="list-style-type: none"> ▪ Address parity error ▪ Posted write data parity error on target bus ▪ Master abort during posted write transaction ▪ Target abort during posted write transaction ▪ Posted write transaction discarded ▪ Delayed write request discarded ▪ Delayed read request discarded ▪ Delayed transaction master timeout ▪ Errors reported from PCI Express port (advanced error reporting) in transparent mode. This signal is an open drain buffer that requires an external pull-up resistor for proper operation.
REQ_L [7:0]	P2, P1, N3, N2, N1, M3, M2, M1	I	Request (Active LOW): REQ_L's are asserted by bus master devices to request for transactions on the PCI bus. The master devices de-assert REQ_Ls for at least 2 PCI clock cycles before asserting them again. If external arbiter is selected (CFN_L=1), REQ_L [0] will be the bus grant input to PI7C9X110. Also, REQ_L [5:2] will become the GPI [3:0].
GNT_L [7:0]	N6, P6, P5, N5, M5, L5, N4, M4	O	Grant (Active LOW): PI7C9X110 asserts GNT_Ls to release PCI bus control to bus master devices. During idle and all GNT_Ls are de-asserted and arbiter is parking to PI7C9X110, PI7C9X110 will drive AD, CBE, and PAR to valid logic levels. If external arbiter is selected (CFN_L=1), GNT_L [0] will be the bus request from PI7C9X110 to external arbiter. Also, GNT_L [5:2] will become the GPO [3:0].
CLKOUT [8:0]	N12, P12, N11, L10, M10, P10, L9, N9, P9	O	PCI Clock Outputs: PCI clock outputs are derived from the CLKIN and provide clocking signals to external PCI Devices.
RESET_L	N7	B	RESET_L (Active LOW): When RESET_L active, all PCI signals should be asynchronously tri-stated.
INTA_L INTB_L INTC_L INTD_L	P3 M6 P13 N13	IOD	Interrupt: Signals are asserted to request an interrupt. After asserted, it can be cleared by the device driver. INTA_L, INTB_L, INTC_L, INTD_L signals are inputs and asynchronous to the clock in the forward mode. In reverse mode, INTA_L, INTB_L, INTC_L, and INTD_L are open drain buffers for sending interrupts to the host interrupt controller.
FBCLKIN	C2	I	Feedback Clock Input: It connects to one of the CLKOUT [8:0] Output Signals and provides internal clocking to PI7C9X110 PCI bus interface.
CLKIN	P7	I	PCI Clock Input: PCI Clock Input Signal connects to an external clock source. PI7C9X110 supports various PCI Frequency from 10MHz to 66MHz. The PCI Clock Outputs CLKOUT [8:0] pins are derived from CLKIN Input.

2.4 MODE SELECT AND STRAPPING SIGNALS

NAME	PIN ASSIGNMENT	TYPE	DESCRIPTION
TM2	K3	I	Mode Select 2: TM2 is a strapping pin. When TM2 is strapped low for normal operations and strapped high for testing functions. See table 3-1 for mode selection and 3-2 for strapping control for details.
TM1	C1	I	Mode Select 1: Mode Selection Pin to select EEPROM or SM Bus. TM1=0 for EEPROM (I2C) support and TM1=1 for SM Bus support. TM1 is also a strapping pin. See table 3-1 mode selection and 3-2 for strapping control.
TM0	D1	I	Mode Select 0: Mode Selection Pin to select transparent or non-transparent mode. TM0=0 for transparent bridge function mode and TM0=1 for non-transparent bridge function mode. TM0 is also a strapping pin. See table 3-1 for mode selection and 3-2 for strapping control.
MSK_IN	P14	I	Mask Input for CLKOUT: MSK_IN is used by PI7C9X110 to enable or disable the clock outputs. MSK_IN is also a strapping pin. When it is strapped to high, hot-plug is enabled. See table 3-2 for strapping control.
REVRSB	M12	I	Forward or Reverse Bridging Pin: REVRSB pin controls the Forward (REVRSB=0) or Reverse (REVRSB=1) Bridge Mode of PI7C9X110. This pin is also a strapping pin. See table 3-1 for mode selection.
CFN_L	M7	ID	Bus Central Function Control Pin (Active Low): To enable the internal arbiter, CFN_L pin should be tied low. When it's tied high, an external arbiter is required to arbitrate the bus. In external arbiter mode, REQ_L [0] is re-configured to be the secondary bus grant input, and GNT_L [0] is reconfigured to be the secondary bus request output. Also, REQ_L [5:2] and GNT_L [5:2] become GPI [3:0] and GPO [3:0] respectively if external arbiter is selected. CFN_L has a weak internal pull-down resistor. See table 3-1 for mode selection.

2.5 JTAG BOUNDARY SCAN SIGNALS

NAME	PIN ASSIGNMENT	TYPE	DESCRIPTION
TCK	L14	IU	Test Clock: TCK is the test clock to synchronize the state information and data on the PCI bus side of PI7C9X110 during boundary scan operation. At normal operation mode, this pin should be left open(NC).
TMS	L13	IU	Test Mode Select: TMS controls the state of the Test Access Port (TAP) controller. At normal operation mode, this pin should be pulled low through a 1K-Ohm pull-down resistor.
TDO	M13	O	Test Data Output: TDO is the test data output and connects to the end of the JTAG scan chain. At normal operation mode, this pin should be left open(NC).
TDI	M14	IU	Test Data Input: TDI is the test data input and connects to the beginning of the JTAG scan chain. It allows the test instructions and data to be serially shifted into the PCI side of PI7C9X110. At normal operation mode, this pin should be left open(NC).
TRST_L	K11	IU	Test Reset (Active LOW): TRST_L is the test reset to initialize the Test Access Port (TAP) controller. At normal operation mode, this pin should be pulled low through a 1K-Ohm pull-down resistor.

2.6 MISCELLANEOUS SIGNALS

NAME	PIN ASSIGNMENT	TYPE	DESCRIPTION
GPIO [3:0]	L7, P8, M8, L8	B	General Purpose I/O Data Pins: The 4 general-purpose signals are programmable as either input-only or bi-directional signals by writing the GPIO output enable control register in the configuration space. See Chapter 8 for more information.
SMBCLK / SCL	A2	B	SMBUS / EEPROM Clock Pin: When EEPROM (I2C) interface is selected (TM1=0), this pin is an output of SCL clock and connected to EEPROM clock input. When SMBUS interface is selected (TM1=1), this pin is an input for the clock of SMBUS.
SMBDATA / SDA	A1	B/IOD	SMBUS / EEPROM Data Pin: Data Interface Pin to EEPROM or SMBUS. When EEPROM (I2C) interface is selected (TM1=0), this pin is a bi-directional signal. When SMBUS interface is selected (TM1=1), this pin is an open drain signal.
PME_L	A3	B	Power Management Event Pin: Power Management Event Signal is asserted to request a change in the device or link power state.
CLKRUN_L	D3	B	Clock Run Pin (Active LOW): The Clock Run signal, for mobile environment, is asserted and de-asserted to indicate the status of the PCI Clock.

NAME	PIN ASSIGNMENT	TYPE	DESCRIPTION
Reserved 0	B1	I	Reserved 0 Pin: For normal PCI operation, Reserved 0 pin is tied to ground with a capacitor (0.1uF) in parallel.
Reserved 1	D2	O	Reserved 1 Pull-up driver: Don't care.

2.7 POWER AND GROUND PINS

NAME	PIN ASSIGNMENT	TYPE	DESCRIPTION
VDDA	J3, G3	P	Analog Voltage Supply for PCI Express Interface: Connect to the 1.8V Power Supply.
VDDP	F3, F4, K2	P	Digital Voltage Supply for PCI Express Interface: Connect to the 1.8V Power Supply.
VDDAUX	F2	P	Auxiliary Voltage Supply for PCI Express Interface: Connect to the 1.8V Power Supply.
VTT	G2, K1	P	Termination Supply Voltage for PCI Express Interface: Connect to the 1.8V Power Supply.
VDDA_PLL	J4	P	Analog Voltage Supply for PLL at PCI Interface: Connect to the 1.8V Power Supply.
VDDC	L1, N8, L11, L12, B12, C10, E4	P	Core Supply Voltage: Connect to the 1.8V Power Supply.
VDDCAUX	L2	P	Auxiliary Core Supply Voltage: Connect to the 1.8V Power Supply.
VD33	L4, N10, M11, K12, J12, H14, F12, E11, D13, A9, C7, A6, C4	P	I/O Supply Voltage for PCI Interface: Connect to the 3.3V Power Supply for PCI I/O Buffers.
VAUX	B2	P	Auxiliary I/O Supply Voltage for PCI interface: Connect to the 3.3V Power Supply.
VSS	E1, H1, H2, J2, J1, K4, P4, L6, M9, P11, K13, H11, G13, E12, E14, C13, C11, D9, B8, D6, B5, C3	P	Ground: Connect to Ground.
VDDA	J3, G3	P	Analog Voltage Supply for PCI Express Interface: Connect to the 1.8V Power Supply.

2.8 PIN ASSIGNMENTS

Table 2-1 Pin Assignments

PIN	NAME	PIN	NAME	PIN	NAME	PIN	NAME
A1	SMBDAT / SDA	C13	VSS	H1	VSS	M3	REQ_L[2]/GPI[0]
A2	SMBCLK / SCL	C14	CBE [1]	H2	VSS	M4	GNT_L [0]
A3	PME_L	D1	TM0	H3	RREF	M5	GNT_L[3]/GPO[1]
A4	AD [30]	D2	Reserved 1	H4	RN	M6	INTB_L
A5	AD [27]	D3	CLKRUN_L	H11	VSS	M7	CFN_L
A6	VD33	D4	AD [28]	H12	AD [4]	M8	GPIO [1]
A7	AD [23]	D5	AD [25]	H13	AD [5]	M9	VSS
A8	AD [20]	D6	VSS	H14	VD33	M10	CLKOUT [4]
A9	VD33	D7	AD [21]	J1	VSS	M11	VD33
A10	CBE [2]	D8	AD [18]	J2	VSS	M12	REVRSB
A11	TRDY_L	D9	VSS	J3	VDDA	M13	TDO
A12	STOP_L	D10	IRDY_L	J4	VDDA_PLL	M14	TDI
A13	LOCK_L	D11	AD [12]	J11	AD [1]	N1	REQ_L[3] / GPI[1]
A14	PERR_L	D12	AD [13]	J12	VD33	N2	REQ_L[4] / GPI[2]
B1	Reserved 0	D13	VD33	J13	AD [2]	N3	REQ_L[5] / GPI[3]
B2	VAUX	D14	AD [14]	J14	AD [3]	N4	GNT_L [1]
B3	AD [31]	E1	VSS	K1	VTT	N5	GNT_L[4]/GPO[2]
B4	AD [29]	E2	REFCLKN	K2	VDDP	N6	GNT_L [7]
B5	VSS	E3	REFCLKP	K3	TM2	N7	RESET_L
B6	AD [24]	E4	VDDC	K4	VSS	N8	VDDC
B7	AD [22]	E11	VD33	K11	TRST_L	N9	CLKOUT [1]

PIN	NAME	PIN	NAME	PIN	NAME	PIN	NAME
B8	VSS	E12	VSS	K12	VD33	N10	VD33
B9	AD [17]	E13	AD [11]	K13	VSS	N11	CLKOUT [6]
B10	FRAME_L	E14	VSS	K14	AD [0]	N12	CLKOUT [8]
B11	DEVSEL_L	F1	TN	L1	VDDC	N13	INTD_L
B12	VDDC	F2	VDDAUX	L2	VDDCAUX	N14	IDSEL
B13	PAR	F3	VDDP	L3	PERST_L	P1	REQ_L [6]
B14	SERR_L	F4	VDDP	L4	VD33	P2	REQ_L [7]
C1	TM1	F11	AD [8]	L5	GNT_L[2]/GPO[0]	P3	INTA_L
C2	FBCLKIN	F12	VD33	L6	VSS	P4	VSS
C3	VSS	F13	AD [9]	L7	GPIO [3]	P5	GNT_L[5]/GPO[3]
C4	VD33	F14	AD [10]	L8	GPIO [0]	P6	GNT_L [6]
C5	AD [26]	G1	TP	L9	CLKOUT [2]	P7	CLKIN
C6	CBE [3]	G2	VTT	L10	CLKOUT [5]	P8	GPIO [2]
C7	VD33	G3	VDDA	L11	VDDC	P9	CLKOUT [0]
C8	AD [19]	G4	RP	L12	VDDC	P10	CLKOUT [3]
C9	AD [16]	G11	AD [6]	L13	TMS	P11	VSS
C10	VDDC	G12	AD [7]	L14	TCK	P12	CLKKOUT [7]
C11	VSS	G13	VSS	M1	REQ_L [0]	P13	INTC_L
C12	AD [15]	G14	CBE [0]	M2	REQ_L [1]	P14	MSK_IN

3 MODE SELECTION AND PIN STRAPPING

3.1 FUNCTIONAL MODE SELECTION

If TM2 is strapped to low, PI7C9X110 uses TM1, TM0, CFN_L, and REVRSB pins to select different modes of operations. These four input signals are required to be stable during normal operation. One of the sixteen combinations of normal operation can be selected by setting the logic values for the four mode select pins. For example, if the logic values are low for all four (TM1, TM0, CFN_L, and REVRSB) pins, the normal operation will have EEPROM (I2C) support in transparent mode with internal arbiter in forward bridge mode. The designated operation with respect to the values of the TM1, TM0, CFN_L, and REVRSB pins are defined on Table 3-1:

Table 3-1 Mode Selection

TM2 Strapped	TM1	TM0	CFN_L	REVRSB	Functional Mode
0	0	X	X	X	EEPROM (I2C) support
0	1	X	X	X	SM Bus support
0	X	0	X	X	Transparent mode
0	X	1	X	X	Non-Transparent mode
0	X	X	0	X	Internal arbiter
0	X	X	1	X	External arbiter
0	X	X	X	0	Forward bridge mode
0	X	X	X	1	Reverse bridge mode

3.2 PIN STRAPPING

If TM2 is strapped to high, PI7C9X110 uses TM1, TM0, and MSK_IN as strapping pins. The strapping functions are listed in Table 3-2 to show the states of operations during the PCI Express PERST_L de-assertion transition in forward bridge mode or PCI RESET_L de-assertion transition in reverse bridge mode.

Table 3-2 Pin Strapping

TM2 Strapped	TM1 Strapped	TM0 Strapped	MSK_IN Strapped	Test Functions
1	0	0	1	PLL test
1	0	1	1	Shorten initialization test with hot-plug enabled
1	1	0	1	Functional loopback test
1	1	1	1	Bridge test (PRBS, IDDQ, etc.)
1	0	0	0	Reserved
1	0	1	0	Shorten initialization test with hot-plug disabled
1	1	0	0	Reserved
1	1	1	0	Reserved

4 FORWARD AND REVERSE BRIDGING

PI7C9X110 supports forward or reverse and transparent or non-transparent combination modes of operation. For example, when PI7C9X110 is operating in forward (REVRSB=0) and non-transparent bridge mode (TM0=1) shown in Figure 4-1, its PCI Express interface is connected to a root complex and its PCI bus interface is connected to PCI devices. Another example, PI7C9X110 can be configured as a reverse (REVRSB=1) and transparent (TM0=0) bridge shown in Figure 4-2.

The non-transparent bridge feature of PI7C9X110 allows the I/O Processor to be isolated from the Host Processor and its memory map which avoiding memory address conflict when both host and I/O processors are needed side-by-side.

PCI based systems and peripherals are ubiquitous in the I/O interconnect technology market today. It will be a tremendous effort to convert existing PCI based products to be used in PCI Express systems. PI7C9X110 provides a solution to bridge existing PCI based products to the latest PCI Express technology.

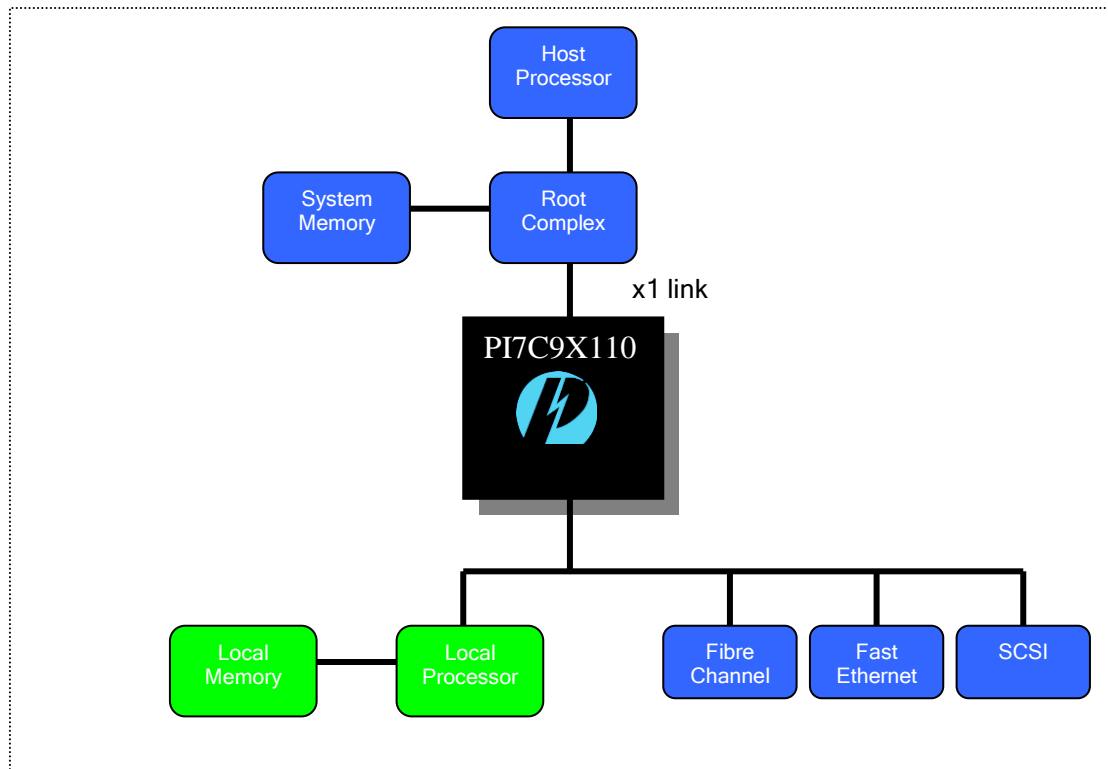
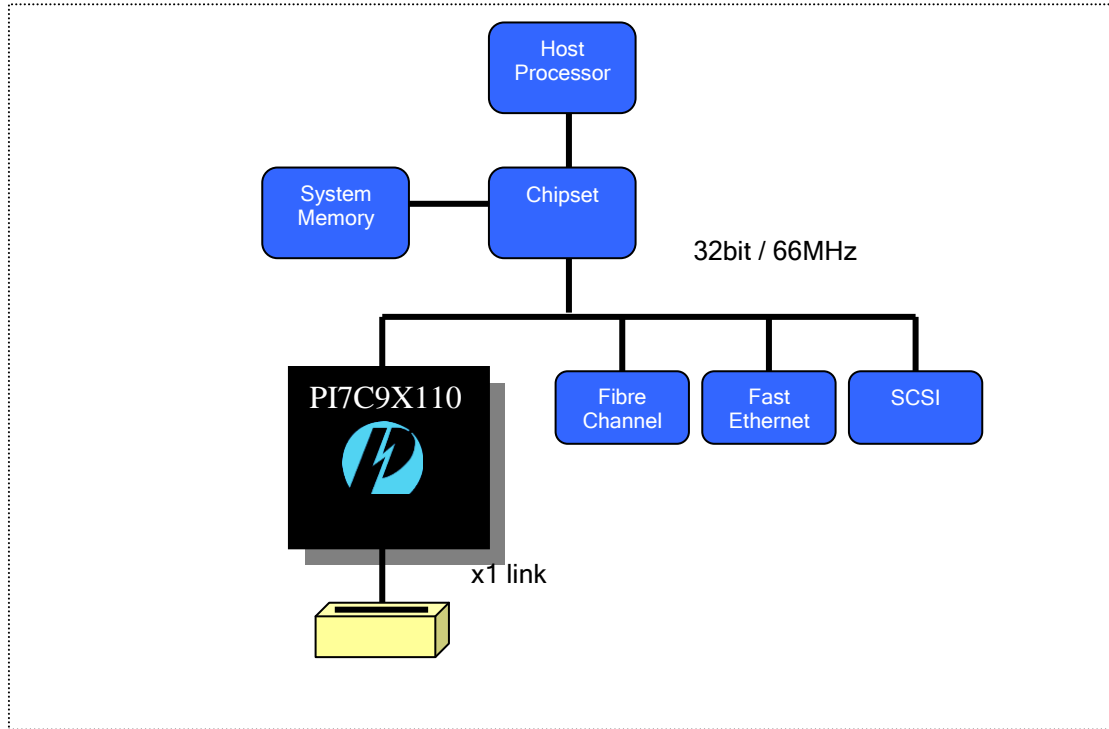

Figure 4-1 Forward and Non-transparent Bridge Mode

In reverse (REVRSB=1) and transparent (TM0=0) mode shown in Figure 3-2, PI7C9X110 becomes a PCI-to-PCI Express bridge that its PCI bus interface is connected to the host chipset between and the PCI Express x1 link. It enables the legacy PCI Host Systems to provide PCI Express capability.

PI7C9X110 provides a solution to convert existing PCI based designs to adapt quickly into PCI Express base platforms. Existing PCI based applications will not have to undergo a complete re-architecture in order to interface to PCI Express technology.

Figure 4-2 Reverse and Transparent Bridge Mode



5 TRANSPARENT AND NON-TRANSPARENT BRIDGING

5.1 TRANSPARENT MODE

In transparent bridge mode, base class code of PI7C9X110 is set to be 06h (bridge device). The sub-class code is set to be 04h (PCI-to-PCI bridge). Programming interface is 00h. Hence, PI7C9X110 is not a subtractive decoding bridge.

PI7C9X110 has type-1 configuration header if TM0 is set to 0 (transparent bridge mode). These configuration registers are the same as traditional transparent PCI-to-PCI Bridge. In fact, it is backward compatible to the software that supporting traditional transparent PCI-to-PCI bridges. Configuration registers can be accessed from several different ways. For PCI Express access, PCI Express configuration transaction is in forward bridge mode. For PCI access, PCI configuration cycle is mainly in reverse bridge mode. However, PI7C9X110 allows PCI configuration access in forward mode as secondary bus configuration access. For I2C access, I2C bus protocol is used with EEPROM selected (TM1=0). For SM bus access, SM bus protocol is used with SM bus selected (TM1=1).

5.2 NON-TRANSPARENT MODE

In non-transparent bridge mode, base class code of PI7C9X110 is set to be 06h (bridge device). The sub-class code is set to be 80h (other bridge). Programming interface is 00h. Hence, PI7C9X110 is not a subtractive decoding bridge.

PI7C9X110 has type-0 configuration header if TM0 is set to 1 (non-transparent mode). The configuration registers are similar to a traditional PCI device. However, there is one set of configuration registers for the primary interface and another set of configuration registers for the secondary interface. In addition, CSRs (Control and Status Registers) are implemented to support the memory or IO transfers between the primary and secondary buses. The CSRs are accessed through memory transaction access within the lowest memory range of 4K Space (bit [64:12] are zeros). The non-transparent configuration registers can be accessed through several different ways (PCI Express, PCI, I2C, and SM bus). For PCI Express and PCI access, the type-0 configuration transactions need to be used. For I2C access, I2C bus protocol needs to be used through I2C bus interface. For SM bus access, SM bus protocol needs to be used through SM bus interface. The hardware pins (A2 and A1) are shared for I2C and SM bus interface. If TM1=0, pin A2 and A1 will be SCL and SDA for I2C interface respectively. If TM1=1, pin A2 and A1 will be SMBCLK and SMBDATA for SM Bus interface respectively.

In non-transparent bridge mode, PI7C9X110 supports four or three memory BARs (Base Address Registers) and one or two IO BARs (Base Address Registers) depending on selection on the primary bus. Also, PI7C9X110 supports four or three memory BARs (Base Address Registers) and one or two IO BARs (Base Address Registers) depending on selection on the secondary bus.

Offset 10h is defined to be primary CSR and downstream memory 0 BAR. Offset 14h is defined to be primary CSR and downstream IO BAR. Offset 18h is defined to be downstream memory 1 or IO BAR (selectable by CSR setup register). Offset 1Ch is defined to be downstream memory 2 BAR. Offset 20h and 24h are defined to be downstream memory 3 lower BAR and memory 3 upper BAR respectively to support 64-bit decoding.

The direct offset translation of address from primary to secondary bus will be done by substituting the original Base Address at primary with the downstream Translation Base Address Register values and keeping the lower address bits the same to form a new address for forward the transaction to secondary bus.

For downstream memory 2, it uses direct address translation. There is no lookup table for downstream memory address translation.

Offset 50h is defined to be secondary CSR and upstream memory 0 BAR. Offset 54h is defined to be secondary CSR and upstream IO BAR. Offset 58h is defined to be upstream memory 1 or IO BAR (selectable by CSR setup register offset E4h). Offset 1Ch is defined to be upstream memory 2 BAR. Offset 60h and 64h are defined to be upstream memory 3 lower BAR and memory 3 upper BAR respectively to support 64-bit decoding.

The direct offset translation of address from secondary to primary bus will be done by substituting the original Base Address at secondary with the upstream Translation Base Address Register values and keeping the lower address bits the same to form a new address for forward the transaction to primary bus.

For upstream memory 2, it uses lookup table address translation method which using the original base address as index to select a new address on the upstream memory 2 lookup table based on the page and window size defined.

Table 5-1 Non-transparent Registers

Non-transparent Registers	Typical access
Primary CSR and Memory 0 BAR	Configuration access offset 10h
Downstream Memory 0 Translated Base	Configuration access offset 98h
Downstream Memory 0 Setup	Configuration access offset 9Ch
Downstream I/O or Memory 1 BAR	Configuration access offset 18h
Downstream I/O or Memory 1 Translated Base	Configuration access offset A8h
Downstream I/O or Memory 1 Setup	Configuration access offset ACh
Downstream Memory 2 BAR	Configuration access offset 1Fh
Downstream Memory 2 Translated Base	Lower 4K I/O or Memory access offset 008h
Downstream Memory 2 Setup	Lower 4K I/O or Memory access offset 00Ch
Downstream Memory 3 BAR	Configuration access offset 23h
Downstream Memory 3 Upper 32-bit BAR	Configuration access offset 27h
Downstream Memory 3 Translated Base	Lower 4K I/O or Memory access offset 010h
Downstream Memory 3 Setup	Lower 4K I/O or Memory access offset 014h
Downstream Memory 3 Upper 32-bit Setup	Lower 4K I/O or Memory access offset 018h
Secondary CSR Memory 0 BAR	Configuration access offset 50h
Upstream Memory 0 Translated Base	Configuration access offset E0h
Upstream Memory 0 Setup	Configuration access offset E4h
Secondary CSR I/O BAR	Configuration access offset 54h
Upstream I/O or Memory 1 BAR	Configuration access offset 58h
Upstream I/O or Memory 1 Translated Base	Configuration access offset E8h
Upstream I/O or Memory 1 Setup	Configuration access offset ECh
Upstream Memory 2 BAR	Configuration access offset 5Fh
Upstream Memory 2 Lookup Table Offset	Lower 4K I/O or Memory access offset 050h
Upstream Memory 2 Lookup Table Data	Lower 4K I/O or Memory access offset 054h
Upstream Memory 2 Lookup Table (64 32-bit entries)	Lower 4K I/O or Memory access offset 100h to 1FFh
Upstream Memory 3 BAR	Configuration access offset 63h
Upstream Memory 3 Upper 32-bit BAR	Configuration access offset 67h
Upstream Memory 3 Setup	Lower 4K I/O or Memory access offset 34h
Upstream Memory 3 Upper 32-bit Setup	Lower 4K I/O or Memory access offset 38h

6 PCI EXPRESS FUNCTIONAL OVERVIEW

6.1 TLP STRUCTURE

PCI Express TLP (Transaction Layer Packet) Structure is comprised of format, type, traffic class, attributes, TLP digest, TLP poison, and length of data payload.

There are four TLP formats defined in PI7C9X110 based on the states of FMT [1] and FMT [0] as shown on Table 6-1.

Table 6-1 TLP Format

FMT [1]	FMT [0]	TLP Format
0	0	3 double word, without data
0	1	4 double word, without data
1	0	3 double word, with data
1	1	4 double word, with data

Data payload of PI7C9X110 can range from 4 (1DW) to 256 (64DW) bytes. PI7C9X110 supports three TLP routing mechanisms. They are comprised of Address, ID, and Implicit routings. Address routing is being used for Memory and IO requests. ID based (bus, device, function numbers) routing is being used for configuration requests. Implicit routing is being used for message routing. There are two message groups (baseline and advanced switching). The baseline message group contains INTx interrupt signaling, power management, error signaling, locked transaction support, slot power limit support, vendor defined messages, hot-plug signaling. The other is advanced switching support message group. The advanced switching support message contains data packet and signal packet messages. Advanced switching is beyond the scope of PI7C9X110 implementation.

The r [2:0] values of the "type" field will determine the destination of the message to be routed. All baseline messages must use the default traffic class zero (TC0).

6.2 VIRTUAL ISOCHRONOUS OPERATION

This section provides a summary of Virtual Isochronous Operation supported by PI7C9X110. Virtual Isochronous support is disabled by default. Virtual Isochronous feature can be turned on with setting bit [26] of offset 40h to one. Control bits are designated for selecting which traffic class (TC1-7) to be used for upstream (PCI Express-to-PCI). PI7C9X110 accepts only TC0 packets of configuration, IO, and message packets for downstream (PCI Express-to-PCI). If configuration, IO and message packets have traffic class other than TC0, PI7C9X110 will treat them as malformed packets. PI7C9X110 maps all downstream memory packets from PCI Express to PCI transactions regardless the virtual Isochronous operation is enabled or not.

7 CONFIGURATION REGISTERS

PI7C9X110 supports Type-0 (non-transparent bridge mode) and Type-1 (transparent bridge mode) configuration space headers and Capability ID of 01h (PCI power management) to 10h (PCI Express capability structure).

With pin REVRSB = 0, device-port type (bit [7:4]) of capability register will be set to 7h (PCI Express-to-PCI bridge). When pin REVRSB = 1, device-port type (bit [7:4]) of capability register will be set to 8h (PCI-to-PCI Express bridge).

PI7C9X110 supports PCI Express capabilities register structure with capability version set to 1h (bit [3:0] of offset 02h).

When pin TM0=0, PI7C9X110 will be in transparent bridge mode and the configuration registers for transparent bridge should be used.

When pin TM0=1, PI7C9X110 will be in non-transparent bridge mode and the configuration registers for non-transparent bridge should be used.

7.1 CONFIGURATION REGISTER MAP

PI7C9X110 supports capability pointer with (ID=07h), PCI power management (ID=01h), PCI bridge sub-system vendor ID (ID=0Dh), PCI Express (ID=10h), vital product data (ID=03h), and message signaled interrupt (ID=05h). Slot identification (ID=04h) is off by default and can be turned on through configuration programming.

Table 7-1 Configuration Register Map (00h – FFh)

Primary Bus Configuration Access for both Transparent and Non-Transparent mode, or Secondary Bus Configuration Access for Transparent Mode	Secondary Bus Configuration Access for Non-Transparent Mode Only	Transparent Mode (type1)	Non-Transparent Mode (Type0)	EEPROM (I2C) Access	SM Bus Access
01h - 00h	01h - 00h	Vendor ID	Vendor ID	Yes1	Yes5
03h - 02h	03h - 02h	Device ID	Device ID	Yes1	Yes5
05h - 04h	45h - 44h	Command Register	Primary Command Register	No	Yes
07h - 06h	47h - 46h	Primary Status Register	Primary Status Register	No	Yes
0Bh - 08h	0Bh - 08h	Class Code and Revision ID	Class Code and Revision ID	Yes1	Yes5
0Ch	4Ch	Cacheline Size Register	Primary Cacheline Size Register	-	-
0Dh	4Dh	Primary Latency Timer	Primary Latency Timer	No	Yes
0Eh	4Eh	Header Type Register	Header Type Register	No	Yes
0Fh	4Fh	Reserved	Reserved	-	-
13h - 10h	53h - 50h	Reserved	Primary CSR and Memory 0 BAR	No	Yes
17h - 14h	57h - 54h	Reserved	Primary CSR I/O BAR	No	Yes
18h	58h	Primary Bus Number Register	Downstream I/O or Memory 1 BAR	No	Yes
19h	59h	Secondary Bus Number Register	Downstream I/O or Memory 1 BAR	No	Yes
1Ah	5Ah	Subordinate Bus Number Register	Downstream I/O or Memory 1 BAR	No	Yes
1Bh	5Bh	Secondary Latency Timer	Downstream I/O or Memory 1 BAR	No	Yes

Primary Bus Configuration Access for both Transparent and Non-Transparent mode, or Secondary Bus Configuration Access for Transparent Mode	Secondary Bus Configuration Access for Non-Transparent Mode Only	Transparent Mode (type1)	Non-Transparent Mode (Type0)	EEPROM (I2C) Access	SM Bus Access
1Ch	5Ch	I/O Base Register	Downstream Memory 2 BAR	No	Yes
1Dh	5Dh	I/O Limit Register	Downstream Memory 2 BAR	No	Yes
1Fh – 1Eh	5Fh – 5Eh	Secondary Status Register	Downstream Memory 2 BAR	No	Yes
21h – 20h	61h – 60h	Memory Base Register	Downstream Memory 3 BAR	No	Yes
23h – 22h	63h – 62h	Memory Limit Register	Downstream Memory 3 BAR	No	Yes
25h – 24h	65h – 64h	Prefetchable Memory Base Register	Downstream Memory 3 Upper 32-bit BAR	No	Yes
27h – 26h	67h – 66h	Prefetchable Memory Limit Register	Downstream Memory 3 Upper 32-bit BAR	No	Yes
2Bh – 28h	2Bh – 28h	Prefetchable Memory Base Upper 32-bit Register		No	Yes
2Dh – 2Ch	2Dh – 2Ch	Prefetchable Memory Limit Upper 32-bit Register	Subsystem Vendor ID	Yes ²	Yes ⁵
2Fh – 2Eh	2Fh – 2Eh	Prefetchable Memory Limit Upper 32-bit Register	Subsystem ID	Yes ²	Yes ⁵
31h – 30h	31h – 30h	I/O Base Upper 16-bit Register	Reserved	No	Yes
33h – 32h	33h – 32h	I/O Limit Upper 16-bit Register	Reserved	No	Yes
34h	34h	Capability Pointer	Capability Pointer	No	Yes
37h – 35h	37h – 35h	Reserved	Reserved	No	Yes
3Bh – 38h	3Bh – 38h	Reserved	Reserved	No	Yes
3Ch	7Ch	Interrupt Line	Primary Interrupt Line	No	Yes
3Dh	7Dh	Interrupt Pin	Primary Interrupt Pin	No	Yes
3Eh	7Eh	Bridge Control	Primary Min_Gnt	Yes ³	Yes ³
3Fh	7Fh	Bridge Control	Primary Max_Lat	Yes ³	Yes ³
41h – 40h	41h – 40h	PCI Data Buffering Control	PCI Data Buffering Control	Yes	Yes
43h – 42h	43h – 42h	Chip Control 0	Chip Control 0	Yes	Yes
45h – 44h	05h – 04h	Reserved	Secondary Command Register	No	Yes
47h – 46h	07h – 06h	Reserved	Secondary Status Register	No	Yes
4Bh – 48h	4Bh – 48h	Arbiter Mode, Enable, Priority	Arbiter Mode, Enable, Priority	Yes	Yes
4Ch	0Ch	Reserved	Secondary Cacheline Size Register	No	Yes
4Dh	0Dh	Reserved	Secondary Status Register	No	Yes
4Eh	0Eh	Reserved	Header Type	No	Yes
4Fh	0Fh	Reserved	Reserved	-	-
53h – 50h	13h – 10h	Reserved	Secondary CSR and Memory 0 BAR	No	Yes
57h – 54h	17h – 14h	Reserved	Secondary CSR I/O BAR	No	Yes
5Bh – 58h	1Bh – 18h	Reserved	Upstream I/O or Memory 1 BAR	No	Yes
5Fh – 5Ch	1Fh – 1Ch	Reserved	Upstream Memory 2 BAR	No	Yes

Primary Bus Configuration Access for both Transparent and Non-Transparent mode, or Secondary Bus Configuration Access for Transparent Mode	Secondary Bus Configuration Access for Non-Transparent Mode Only	Transparent Mode (type1)	Non-Transparent Mode (Type0)	EEPROM (I2C) Access	SM Bus Access
63h – 60h	23h – 20h	Reserved	Upstream Memory 3 BAR	No	Yes
67h – 64h	27h – 24h	Reserved	Upstream Memory 3 Upper 32-bit BAR	No	Yes
69h – 68h	69h – 68h	PCI Express Tx and Rx Control	PCI Express Tx and Rx Control	Yes	Yes
6Ah	6Ah	Reserved	Memory Address Forwarding Control	Yes ³	Yes ³
6Bh	6Bh	Reserved	Reserved	No	Yes
6Dh – 6Ch	6Dh – 6Ch	Reserved	Subsystem Vendor ID	Yes ²	Yes ⁵
6Fh – 6Eh	6Fh – 6Eh	Reserved	Subsystem ID	Yes ²	Yes ³
73h – 70h	73h – 70h	EEPROM (I2C) Control and Status Register	EEPROM (I2C) Control and status Register	No	Yes
77h – 74h	77h – 74h	Reserved	Reserved	No	Yes
7Bh – 78h	7Bh – 78h	GPIO Data and Control (20 bits)	GPIO Data and Control (20 bits)	No	Yes
7Bh – 78h	7Bh – 78h	Reserved (12 bits)	Bridge Control and Status (10 bits)	No	No
7Bh – 78h	7Bh – 78h	Reserved (12 bits)	Reserved (2 bits)	No	No
7Ch	3Ch	Reserved	Secondary Interrupt Line	No	Yes
7Dh	3Dh	Reserved	Secondary Interrupt Pin	No	Yes
7Eh	3Eh	Reserved	Secondary Min_Gnt	Yes ³	Yes ³
7Fh	3Fh	Reserved	Secondary Max_Lat	Yes ³	Yes ³
83h – 80h	83h – 80h	Capability	Capability	No	Yes
87h – 84h	87h – 84h	Bridge Status	Bridge Status	No	Yes
8Bh – 88h	8Bh – 88h	Upstream Split Transaction	Upstream Split Transaction	No	Yes
8Fh – 8Ch	8Fh – 8Ch	Downstream Split Transaction	Downstream Split Transaction	No	Yes
93h – 90h	93h – 90h	Power Management Capability	Power Management Capability	Yes	Yes
97h – 94h	97h – 94h	Power Management Control and Status	Power Management Control and Status	No	Yes
9Bh – 98h	9Bh – 98h	Reserved	Downstream Memory 0 Translated Base	No	Yes
9Fh – 9Ch	9Fh – 9Ch	Reserved	Downstream Memory 0 Setup	Yes ³	Yes ³
A3h – A0h	A3h – A0h	Slot ID Capability	Slot ID Capability	No	Yes
A7h – A4h	A7h – A4h	PCI Clock and CLKRUN Control	PCI Clock and CLKRUN Control	Yes	Yes
ABh – A8h	ABh – A8h	SSID and SSVID Capability	Downstream I/O or Memory 1 Translated Base	No	Yes
Afh – ACh	Afh – ACh	Subsystem ID and Subsystem Vendor ID	Downstream I/O or Memory 1 Setup	Yes	Yes
B3h – B0h	B3h – B0h	PCI Express Capability	PCI Express Capability	No	Yes
B7h – B4h	B7h – B4h	Device Capability	Device Capability	Yes	Yes
BBh – B8h	BBh – B8h	Device Control and Status	Device Control and Status	No	Yes
BFh – BCh	BFh – BCh	Link Capability	Link Capability	Yes	Yes
C3h – C0h	C3h – C0h	Link Control and Status	Link Control and Status	No	Yes
C7h – C4h	C7h – C4h	Slot Capability	Slot Capability	No	Yes
CBh – C8h	CBh – C8h	Slot Control and Status	Slot Control and Status	No	Yes

Primary Bus Configuration Access for both Transparent and Non-Transparent mode, or Secondary Bus Configuration Access for Transparent Mode	Secondary Bus Configuration Access for Non-Transparent Mode Only	Transparent Mode (type1)	Non-Transparent Mode (Type0)	EEPROM (I2C) Access	SM Bus Access
CFh – CCh	CFh – CCh	XPIP Configuration Register 0	XPIP Configuration Register 0	Yes	Yes
D3h – D0h	D3h – D0h	XPIP Configuration Register 1	XPIP Configuration Register 1	Yes	Yes
D6h – D4h	D6h – D4h	XPIP Configuration Register 2	XPIP Configuration Register 2	Yes	Yes
D7h	D7h	Reserved	Reserved	Yes	Yes
DBh – D8h	DBh – D8h	VPD Capability Register	VPD Capability Register	No	Yes
DFh – DCh	DFh – DCh	VPD Data Register	VPD Data Register	Yes ⁴	Yes
E3h – E0h	E3h – E0h	Reserved	Upstream Memory 0 Translated Base	No	Yes
E7h – E4h	E7h – E4h	Reserved	Upstream Memory 0 setup	Yes ³	Yes ³
EBh – E8h	EBh – E8h	Reserved	Upstream I/O or Memory 1 Translated Base	No	Yes
EFh – ECh	EFh – ECh	Reserved	Upstream I/O or Memory 1 Setup	Yes ³	Yes ³
F3h – F0h	F3h – F0h	MSI Capability Register	MSI Capability Register	No	Yes
F7h – F4h	F7h – F4h	Message Address	Message Address	No	Yes
FBh – F8h	FBh – F8h	Message Upper Address	Message Upper Address	No	Yes
FFh – FCh	FFh – FCh	Message Date	Message Date	No	Yes

Note 1: When masquerade is enabled, it is pre-loadable.

Note 2: When both masquerade and non-transparent mode are enabled, it is pre-loadable.

Note 3: When non-transparent mode is enabled, it is pre-loadable.

Note 4: The VPD data is read/write through I2C during VPD operation.

Note 5: Read access only.

7.2 PCI EXPRESS EXTENDED CAPABILITY REGISTER MAP

PI7C9X110 also supports PCI Express Extended Capabilities with from 257-byte to 4096-byte space. The offset range is from 100h to FFFh. The offset 100h is defined for Advance Error Reporting (ID=0001h). The offset 150h is defined for Virtual Channel (ID=0002h).

Table 7-2 PCI Express Extended Capability Register Map (100h – FFFh)

Primary Bus Configuration Access for both Transparent and Non-Transparent mode, or Secondary Bus Configuration Access for Transparent Mode	Secondary Bus Configuration Access for Non-Transparent Mode Only	Transparent Mode (type1)	Non-Transparent Mode (Type0)	EEPROM (I2C) Access	SM Bus Access
103h – 100h	103h – 100h	Advanced Error Reporting (AER) Capability	Advanced Error Reporting (AER) Capability	No	Yes ³
107h – 104h	107h – 104h	Uncorrectable Error Status	Uncorrectable Error Status	No	Yes
10Bh – 108h	10Bh – 108h	Uncorrectable Error Mask	Uncorrectable Error Mask	No	Yes
10Fh – 10Ch	10Fh – 10Ch	Uncorrectable Severity	Uncorrectable Severity	No	Yes

Primary Bus Configuration Access for both Transparent and Non-Transparent mode, or Secondary Bus Configuration Access for Transparent Mode	Secondary Bus Configuration Access for Non-Transparent Mode Only	Transparent Mode (type1)	Non-Transparent Mode (Type0)	EEPROM (I2C) Access	SM Bus Access
113h – 110h	113h – 110h	Correctable Error Status	Correctable Error Status	No	Yes
117h – 114h	117h – 114h	Correctable Error Mask	Correctable Error Mask	No	Yes
11Bh – 118h	11Bh – 118h	AER Control	AER Control	No	Yes
12Bh – 11Ch	12Bh – 11Ch	Header Log Register	Header Log Register	No	Yes
12Fh – 12Ch	12Fh – 12Ch	Secondary Uncorrectable Error Status	Secondary Uncorrectable Error Status	No	Yes
133h – 130h	133h – 130h	Secondary Uncorrectable Error Mask	Secondary Uncorrectable Error Mask	No	Yes
137h – 134h	137h – 134h	Secondary Uncorrectable Severity	Secondary Uncorrectable Severity	No	Yes
13Bh – 138h	13Bh – 138h	Secondary AER Control	Secondary AER Control	No	Yes
14Bh – 13Ch	14Bh – 13Ch	Secondary Header Log Register	Secondary Header Log Register	No	Yes
14Fh – 14Ch	14Fh – 14Ch	Reserved	Reserved	No	Yes
153h – 150h	153h – 150h	VC Capability	VC Capability	No	Yes
157h – 154h	157h – 154h	Port VC Capability 1	Port VC Capability 1	No	Yes
15Bh – 158h	15Bh – 158h	Port VC Capability 2	Port VC Capability 2	No	Yes
15Fh – 15Ch	15Fh – 15Ch	Port VC Status and Control	Port VC Status and Control	No	Yes
163h – 160h	163h – 160h	VC0 Resource Capability	VC0 Resource Capability	No	Yes
167h – 164h	167h – 164h	VC0 Resource Control	VC0 Resource Control	No	Yes
16Bh – 168h	16Bh – 168h	VC0 Resource Status	VC0 Resource Status	No	Yes
2Fh – 170h	2Fh – 170h	Reserved	Reserved	No	No
303h – 300h	503h – 500h	Reserved	Reserved	No	Yes
307h – 304h	507h – 504h	Extended GPI/GPO Data and Control	Extended GPI/GPO Data and Control	No	Yes
30Fh – 308h	50Fh – 508h	Reserved	Reserved	No	No
310h	510h	Replay and Acknowledge Latency Timer	Replay and Acknowledge Latency Timer	Yes	Yes
4Fh – 314h	4Fh – 314h	Reserved	Reserved	No	No
503h – 500h	303h – 300h	Reserved	Reserved	No	No
504h	304h	Reserved	Reserved	No	No
50Fh – 505h	30Fh – 305h	Reserved	Reserved	No	No
510h	310h	Reserved	Reserved	No	No
FFh – 514h	FFFh – 514h	Reserved	Reserved	No	No

Note 5: Read access only.

7.3 CONTROL AND STATUS REGISTER MAP

Table 7-3 Control and Status Register (CSR) Map (000h – FFFh)

PCI Express / PCI Memory Offset	SM Bus Offset	Register Name	Reset Value	EEPROM (I2C) Access	SM Bus Access
007h – 000h	207h – 200h	Reserved	0	No	Yes
00Bh – 008h	20Bh – 208h	Downstream Memory 2 Translated Base	XXXX_XXXXh	No	Yes
00Fh – 00Ch	20Fh – 20Ch	Downstream Memory 2 Setup	0000_0000h	Yes	Yes

PCI Express / PCI Memory Offset	SM Bus Offset	Register Name	Reset Value	EEPROM (I2C) Access	SM Bus Access
013h – 010h	213h – 210h	Downstream Memory 3 Translated Base	XXXX_XXXXh	No	Yes
017h – 014h	217h – 214h	Downstream Memory 3 Setup	0000_0000h	Yes	Yes
01Bh – 018h	21Bh – 218h	Downstream Memory 3 Upper 32-bit Setup	0000_0000h	Yes	Yes
02Fh – 01Ch	22Fh – 21Ch	Reserved	0	No	Yes
033h – 030h	233h – 230h	Reserved	X	No	Yes
037h – 034h	237h – 234h	Upstream Memory 3 Setup	0000_0000h	Yes	Yes
03Bh – 038h	21Bh – 218h	Upstream Memory 3 Upper 32-bit Setup	0000_0000h	Yes	Yes
04Fh – 03Ch	24Fh – 23Ch	Reserved	0	No	Yes
050h	250h	Lookup Table Offset Register	XXh	No	Yes
053h – 051h	253h – 251h	Reserved	0	No	Yes
057h – 054h	257h – 254h	Lookup Table Data Register	XXXX_XXXXh	No	Yes
05Bh – 058h	25Bh – 258h	Upstream Page Boundary IRQ 0	0000_0000h	No	Yes
05Fh – 05Ch	25Fh – 25Ch	Upstream Page Boundary IRQ 1	0000_0000h	No	Yes
063h – 060h	263h – 260h	Upstream Page Boundary IRQ Mask 0	FFFF_FFFFh	No	Yes
067h – 064h	267h – 264h	Upstream Page Boundary IRQ Mask 1	FFFF_FFFFh	No	Yes
06Fh – 068h	26Fh – 268h	Reserved	0	No	Yes
071h – 070h	271h – 270h	Primary Clear IRQ Register	0000h	No	Yes
073h – 072h	273h – 272h	Secondary Clear IRQ Register	0000h	No	Yes
075h – 074h	275h – 274h	Primary Set IRQ Register	0000h	No	Yes
077h – 076h	277h – 276h	Secondary Set IRQ Register	0000h	No	Yes
079h – 078h	279h – 278h	Primary Clear IRQ Mask Register	FFFFh	No	Yes
07Bh – 07Ah	27Bh – 27Ah	Secondary Clear IRQ Mask Register	FFFFh	No	Yes
07Dh – 07Ch	27Dh – 27Ch	Primary Set IRQ Mask Register	FFFFh	No	Yes
07Fh – 07Eh	27Fh – 27Eh	Secondary Set IRQ Mask Register	FFFFh	No	Yes
09Fh – 080h	29Fh – 280h	Reserved	0	No	Yes
0A3h – 0A0h	2A3h – 2A0h	Scratch pad 0	XXXX_XXXXh	No	Yes
0A7h – 0A4h	2A7h – 2A4h	Scratch pad 1	XXXX_XXXXh	No	Yes
0ABh – 0A8h	2ABh – 2A8h	Scratch pad 2	XXXX_XXXXh	No	Yes
0AFh – 0ACh	2AFh – 2ACh	Scratch pad 3	XXXX_XXXXh	No	Yes
0B3h – 0B0h	2B3h – 2B0h	Scratch pad 4	XXXX_XXXXh	No	Yes
0B7h – 0B4h	2B7h – 2B4h	Scratch pad 5	XXXX_XXXXh	No	Yes
0BBh – 0B8h	2BBh – 2B8h	Scratch pad 6	XXXX_XXXXh	No	Yes
0BFh – 0BCh	2BCh – 2BFh	Scratch pad 7	XXXX_XXXXh	No	Yes
0FFh – 0C0h	2FFh – 2C0h	Reserved	0	No	Yes
1FFh – 100h	3FFh – 300h	Upstream Memory 2 Lookup Table	0	No	Yes
FFFh – 200h	11FFh – 400h	Reserved	0	No	Yes

7.4 PCI CONFIGURATION REGISTERS FOR TRANSPARENT BRIDGE MODE

The following section describes the configuration space when the device is in transparent mode. The descriptions for different register type are listed as follow:

Register Type	Descriptions
RO	Read Only
ROS	Read Only and Sticky
RW	Read/Write
RWC	Read/Write "1" to clear
RWS	Read/Write and Sticky
RWCS	Read/Write "1" to clear and Sticky

7.4.1 VENDOR ID – OFFSET 00h

BIT	FUNCTION	TYPE	DESCRIPTION
15:0	Vendor ID	RO	Identifies Pericom as the vendor of this device. Returns 12D8h when read.

7.4.2 DEVICE ID – OFFSET 00h

BIT	FUNCTION	TYPE	DESCRIPTION
31:16	Device ID	RO	Identifies this device as the PI7C9X110. Returns E110 when read.

7.4.3 COMMAND REGISTER – OFFSET 04h

BIT	FUNCTION	TYPE	DESCRIPTION
0	I/O Space Enable	RW	0: Ignore I/O transactions on the primary interface 1: Enable response to memory transactions on the primary interface Reset to 0
1	Memory Space Enable	RW	0: Ignore memory read transactions on the primary interface 1: Enable memory read transactions on the primary interface Reset to 0
2	Bus Master Enable	RW	0: Do not initiate memory or I/O transactions on the primary interface and disable response to memory and I/O transactions on the secondary interface 1: Enable the bridge to operate as a master on the primary interfaces for memory and I/O transactions forwarded from the secondary interface. If the primary of the reverse bridge is mode, the bridge is allowed to initiate a split completion transaction regardless of the status bit. Reset to 0
3	Special Cycle Enable	RO	0: PI7C9X110 does not respond as a target to Special Cycle transactions, so this bit is defined as Read-Only and must return 0 when read Reset to 0
4	Memory Write and Invalidate Enable	RO	0: PI7C9X110 does not originate a Memory Write and Invalidate transaction. Implements this bit as Read-Only and returns 0 when read (unless forwarding a transaction for another master). Reset to 0
5	VGA Palette Snoop Enable	RO / RW	<u>This bit applies to reverse bridge only.</u> 0: Ignore VGA palette access on the primary 1: Enable positive decoding response to VGA palette writes on the primary interface with I/O address bits AD [9:0] equal to 3C6h, 3C8h, and 3C9h (inclusive of ISA alias; AD [15:0] are not decoded and may be any value) Reset to 0

BIT	FUNCTION	TYPE	DESCRIPTION
6	Parity Error Response Enable	RW	0: May ignore any parity error that is detected and take its normal action 1: This bit if set, enables the setting of Master Data Parity Error bit in the Status Register when poisoned TLP received or parity error is detected and takes its normal action Reset to 0
7	Wait Cycle Control	RO	Wait cycle control not supported Reset to 0
8	SERR_L Enable Bit	RW	0: Disable 1: Enable PI7C9X110 in forward bridge mode to report non-fatal or fatal error message to the Root Complex. Also, in reverse bridge mode to assert SERR_L on the primary interface Reset to 0
9	Fast Back-to-Back Enable	RO	Fast back-to-back enable not supported Reset to 0
10	Interrupt Disable	RO / RW	This bit applies to reverse bridge only. 0: INTA_L, INTB_L, INTC_L, and INTD_L can be asserted on PCI interface 1: Prevent INTA_L, INTB_L, INTC_L, and INTD_L from being asserted on PCI interface Reset to 0
15:11	Reserved	RO	Reset to 00000

7.4.4 PRIMARY STATUS REGISTER – OFFSET 04h

BIT	FUNCTION	TYPE	DESCRIPTION
18:16	Reserved	RO	Reset to 000
19	Reserved (transparent mode)	RO	Reset to 0
20	Capability List Capable	RO	1: PI7C9X110 supports the capability list (offset 34h in the pointer to the data structure) Reset to 1
21	66MHz Capable	RO	This bit applies to reverse bridge only. 1: 66MHz capable Reset to 0 when forward bridge or 1 when reverse bridge.
22	Reserved	RO	Reset to 0
23	Fast Back-to-Back Capable	RO	This bit applies to reverse bridge only. 1: Enable fast back-to-back transactions Reset to 0 when forward bridge or 1 when reverse bridge in PCI mode.
24	Master Data Parity Error Detected	RWC	Bit set if its Parity Error Enable bit is set and either of the conditions occurs on the primary: FORWARD BRIDGE – Receives a completion marked poisoned Poisons a write request REVERSE BRIDGE – Detected parity error when receiving data or Split Response for read Observes P_PERR_L asserted when sending data or receiving Split Response for write Receives a Split Completion Message indicating data parity error occurred for non-posted write Reset to 0

BIT	FUNCTION	TYPE	DESCRIPTION
26:25	DEVSEL_L Timing (medium decode)	RO	<u>These bits apply to reverse bridge only.</u> 00: fast DEVSEL_L decoding 01: medium DEVSEL_L decoding 10: slow DEVSEL_L decoding 11: reserved Reset to 00 when forward bridge or 01 when reverse bridge.
27	Signaled Target Abort	RWC	FORWARD BRIDGE – This bit is set when PI7C9X110 completes a request using completer abort status on the primary REVERSE BRIDGE – This bit is set to indicate a target abort on the primary Reset to 0
28	Received Target Abort	RWC	FORWARD BRIDGE – This bit is set when PI7C9X110 receives a completion with completer abort completion status on the primary REVERSE BRIDGE – This bit is set when PI7C9X110 detects a target abort on the primary Reset to 0
29	Received Master Abort	RWC	FORWARD BRIDGE – This bit is set when PI7C9X110 receives a completion with unsupported request completion status on the primary REVERSE BRIDGE – This bit is set when PI7C9X110 detects a master abort on the primary
30	Signaled System Error	RWC	FORWARD BRIDGE – This bit is set when PI7C9X110 sends an ERR_FATAL or ERR_NON_FATAL message on the primary REVERSE BRIDGE – This bit is set when PI7C9X110 asserts SERR_L on the primary Reset to 0
31	Detected Parity Error	RWC	FORWARD BRIDGE – This bit is set when poisoned TLP is detected on the primary REVERSE BRIDGE – This bit is set when address or data parity error is detected on the primary Reset to 0

7.4.5 REVISION ID REGISTER – OFFSET 08h

BIT	FUNCTION	TYPE	DESCRIPTION
7:0	Revision	RO	Reset to 00000004h

7.4.6 CLASS CODE REGISTER – OFFSET 08h

BIT	FUNCTION	TYPE	DESCRIPTION
15:8	Programming Interface	RO	Subtractive decoding of PCI-PCI bridge not supported Reset to 00000000
23:16	Sub-Class Code	RO	Sub-Class Code 00000100: PCI-to-PCI bridge Reset to 00000100
31:24	Base Class Code	RO	Base class code 00000110: Bridge Device (transparent mode) Reset to 00000110 (transparent mode)

7.4.7 CACHE LINE SIZE REGISTER – OFFSET 0Ch

BIT	FUNCTION	TYPE	DESCRIPTION
1:0	Reserved	RO	Bit [1:0] not supported Reset to 00
2	Cache Line Size	RW	1: Cache line size = 4 double words Reset to 0
3	Cache Line Size	RW	1: Cache line size = 8 double words Reset to 0
4	Cache Line Size	RW	1: Cache line size = 16 double words Reset to 0
5	Cache Line Size	RW	1: Cache line size = 32 double words Reset to 0
7:6	Reserved	RO	Bit [7:6] not supported Reset to 00

7.4.8 PRIMARY LATENCY TIMER REGISTER – OFFSET 0Ch

BIT	FUNCTION	TYPE	DESCRIPTION
15:8	Primary Latency Timer	RO / RW	8 bits of primary latency timer in PCI FORWARD BRIDGE – RO with reset to 00h REVERSE BRIDGE – RW with reset to 00h in PCI mode

7.4.9 PRIMARY HEADER TYPE REGISTER – OFFSET 0Ch

BIT	FUNCTION	TYPE	DESCRIPTION
22:16	PCI-to-PCI bridge configuration (transparent mode)	RO	PCI-to-PCI bridge configuration (10 – 3Fh) Reset to 0000001 (transparent mode)
	Other bridge configuration (non-transparent mode)	RO	Type-0 header format configuration (10-3Fh) Reset to 0000000 (non-transparent mode)
23	Single Function Device	RO	0: Indicates single function device Reset to 0
31:24	Reserved	RO	Reset to 00h

7.4.10 RESERVED REGISTERS – OFFSET 10h TO 17h

7.4.11 PRIMARY BUS NUMBER REGISTER – OFFSET 18h

BIT	FUNCTION	TYPE	DESCRIPTION
7:0	Primary Bus Number	RW	Reset to 00h

7.4.12 SECONDARY BUS NUMBER REGISTER – OFFSET 18h

BIT	FUNCTION	TYPE	DESCRIPTION
15:8	Secondary Bus Number	RW	Reset to 00h

7.4.13 SUBORDINATE BUS NUMBER REGISTER – OFFSET 18h

BIT	FUNCTION	TYPE	DESCRIPTION
23:16	Subordinate Bus Number	RW	Reset to 00h

7.4.14 SECONDARY LATENCY TIME REGISTER – OFFSET 18h

BIT	FUNCTION	TYPE	DESCRIPTION
31:24	Secondary Latency Timer	RW / RO	Secondary latency timer in PCI FORWARD BRIDGE – RW with reset to 00h in PCI mode REVERSE BRIDGE – RO with reset to 00h

7.4.15 I/O BASE REGISTER – OFFSET 1Ch

BIT	FUNCTION	TYPE	DESCRIPTION
1:0	32-bit I/O Addressing Support	RO	01: Indicates PI7C9X110 supports 32-bit I/O addressing Reset to 01
3:2	Reserved	RO	Reset to 00
7:4	I/O Base	RW	Indicates the I/O base (0000_0000h) Reset to 0000

7.4.16 I/O LIMIT REGISTER – OFFSET 1Ch

BIT	FUNCTION	TYPE	DESCRIPTION
9:8	32-bit I/O Addressing Support	RO	01: Indicates PI7C9X110 supports 32-bit I/O addressing Reset to 01
11:10	Reserved	RO	Reset to 00
15:12	I/O Base	RW	Indicates the I/O Limit (0000_0FFFh) Reset to 0000

7.4.17 SECONDARY STATUS REGISTER – OFFSET 1Ch

BIT	FUNCTION	TYPE	DESCRIPTION
20:16	Reserved	RO	Reset to 00000
21	66MHz Capable	RO	Indicates PI7C9X110 is 66MHz capable Reset to 1
22	Reserved	RO	Reset to 0
23	Fast Back-to-Back Capable	RO	FORWARD BRIDGE: reset to 1 when secondary bus is in PCI mode (supports fast back-to-back transactions) REVERSE BRIDGE: reset to 0 (does not support fast back-to-back transactions)
24	Master Data Parity Error Detected	RWC	This bit is set if its parity error enable bit is set and either of the conditions occur on the primary: FORWARD BRIDGE – <ul style="list-style-type: none"> Detected parity error when receiving data or split response for read Observes S_PERR_L asserted when sending data or receiving split response for write Receives a split completion message indicating data parity error occurred for non-posted write REVERSE BRIDGE – <ul style="list-style-type: none"> Receives a completion marked poisoned Poisons a write request Reset to 0

BIT	FUNCTION	TYPE	DESCRIPTION
26:25	DEVSEL_L Timing (medium decoding)	RO	These bits apply to forward bridge only. 01: medium DEVSEL_L decoding Reset to 01 when forward mode or 00 when reverse mode.
27	Signaled Target Abort	RWC	FORWARD BRIDGE – Bit is set when PI7C9X110 signals target abort REVERSE BRIDGE – Bit is set when PI7C9X110 completes a request using completer abort completion status Reset to 0
28	Received Target Abort	RWC	FORWARD BRIDGE – Bit is set when PI7C9X110 detects target abort on the secondary interface REVERSE BRIDGE – Bit is set when PI7C9X110 receives a completion with completer abort completion status on the secondary interface Reset to 0
29	Received Master Abort	RWC	FORWARD BRIDGE – Bit is set when PI7C9X110 detects master abort on the secondary interface REVERSE BRIDGE – Bit is set when PI7C9X110 receives a completion with unsupported request completion status on the primary interface Reset to 0
30	Received System Error	RWC	FORWARD BRIDGE – Bit is set when PI7C9X110 detects SERR_L assertion on the secondary interface REVERSE BRIDGE – Bit is set when PI7C9X110 receives an ERR_FATAL or ERR_NON_FATAL message on the secondary interface Reset to 0
31	Detected Parity Error	RWC	FORWARD BRIDGE – Bit is set when PI7C9X110 detects address or data parity error REVERSE BRIDGE – Bit is set when PI7C9X110 detects poisoned TLP on secondary interface Reset to 0

7.4.18 MEMORY BASE REGISTER – OFFSET 20h

BIT	FUNCTION	TYPE	DESCRIPTION
3:0	Reserved	RO	Reset to 0000
15:4	Memory Base	RW	Memory Base (80000000h) Reset to 800h

7.4.19 MEMORY LIMIT REGISTER – OFFSET 20h

BIT	FUNCTION	TYPE	DESCRIPTION
19:16	Reserved	RO	Reset to 0000
31:20	Memory Limit	RW	Memory Limit (000FFFFh) Reset to 000h

7.4.20 PREFETCHABLE MEMORY BASE REGISTER – OFFSET 24h

BIT	FUNCTION	TYPE	DESCRIPTION
3:0	64-bit Addressing Support	RO	0001: Indicates PI7C9X110 supports 64-bit addressing Reset to 0001

BIT	FUNCTION	TYPE	DESCRIPTION
15:4	Prefetchable Memory Base	RW	Prefetchable Memory Base (00000000_80000000h) Reset to 800h

7.4.21 PREFETCHABLE MEMORY LIMIT REGISTER – OFFSET 24h

BIT	FUNCTION	TYPE	DESCRIPTION
19:16	64-bit Addressing Support	RO	0001: Indicates PI7C9X110 supports 64-bit addressing Reset to 0001
31:20	Prefetchable Memory Limit	RW	Prefetchable Memory Limit (00000000_000FFFFFh) Reset to 000h

7.4.22 PREFETCHABLE BASE UPPER 32-BIT REGISTER – OFFSET 28h

BIT	FUNCTION	TYPE	DESCRIPTION
31:0	Prefetchable Base Upper 32-bit	RW	Bit [63:32] of prefetchable base Reset to 00000000h

7.4.23 PREFETCHABLE LIMIT UPPER 32-BIT REGISTER – OFFSET 2Ch

BIT	FUNCTION	TYPE	DESCRIPTION
31:0	Prefetchable Limit Upper 32-bit	RW	Bit [63:32] of prefetchable limit Reset to 00000000h

7.4.24 I/O BASE UPPER 16-BIT REGISTER – OFFSET 30h

BIT	FUNCTION	TYPE	DESCRIPTION
15:0	I/O Base Upper 16-bit	RW	Bit [31:16] of I/O Base Reset to 0000h

7.4.25 I/O LIMIT UPPER 16-BIT REGISTER – OFFSET 30h

BIT	FUNCTION	TYPE	DESCRIPTION
31:16	I/O Limit Upper 16-bit	RW	Bit [31:16] of I/O Limit Reset to 0000h

7.4.26 CAPABILITY POINTER – OFFSET 34h

BIT	FUNCTION	TYPE	DESCRIPTION
31:8	Reserved	RO	Reset to 0
7:0	Capability Pointer	RO	Capability pointer to 80h Reset to 80h

7.4.27 EXPANSION ROM BASE ADDRESS REGISTER – OFFSET 38h

BIT	FUNCTION	TYPE	DESCRIPTION
31:0	Expansion ROM Base Address	RO	Expansion ROM not supported. Reset to 00000000h

7.4.28 INTERRUPT LINE REGISTER – OFFSET 3Ch

BIT	FUNCTION	TYPE	DESCRIPTION
7:0	Interrupt Line	RW	<p><u>These bits apply to reverse bridge only.</u></p> <p>For initialization code to program to tell which input of the interrupt controller the PI7C9X110's INTA_L is connected to.</p> <p>Reset to 00000000</p>

7.4.29 INTERRUPT PIN REGISTER – OFFSET 3Ch

BIT	FUNCTION	TYPE	DESCRIPTION
15:8	Interrupt Pin	RO	<p><u>These bits apply to reverse bridge only.</u></p> <p>Designates interrupt pin INTA_L, is used</p> <p>Reset to 01h when forward mode and reverse mode.</p>

7.4.30 BRIDGE CONTROL REGISTER – OFFSET 3Ch

BIT	FUNCTION	TYPE	DESCRIPTION
16	Parity Error Response Enable	RW	<p>0: Ignore parity errors on the secondary 1: Enable parity error detection on secondary</p> <p>FORWARD BRIDGE – Controls the response to uncorrectable address attribute and data errors on the secondary REVERSE BRIDGE – Controls the setting of the master data parity error bit in response to a received poisoned TLP from the secondary (PCIe link)</p> <p>Reset to 0</p>
17	SERR_L Enable	RW	<p>0: Disable the forwarding of SERR_L to ERR_FATAL and ERR_NONFATAL 1: Enable the forwarding of SERR_L to ERR_FATAL and ERR_NONFATAL</p> <p>Reset to 0 (FORWARD BRIDGE) RO bit for REVERSE BRIDGE</p>
18	ISA Enable	RW	<p>0: Forward downstream all I/O addresses in the address range defined by the I/O Base and Limit registers 1: Forward upstream all I/O addresses in the address range defined by the I/O Base and Limit registers that are in the first 64KB of PCI I/O address space (top 768 bytes of each 1KB block)</p> <p>Reset to 0</p>
19	VGA Enable	RW	<p>0: Do not forward VGA compatible memory and I/O addresses from the primary to secondary, unless they are enabled for forwarding by the defined I/O and memory address ranges 1: Forward VGA compatible memory and I/O addresses from the primary and secondary (if the I/O enable and memory enable bits are set), independent of the ISA enable bit</p>
20	VGA 16-bit Decode	RW	<p>0: Execute 10-bit address decodes on VGA I/O accesses 1: Execute 16-bit address decode on VGA I/O accesses</p> <p>Reset to 0</p>
21	Master Abort Mode	RW	<p>0: Do not report master aborts (return FFFFFFFFh on reads and discards data on write) 1: Report master abort by signaling target abort if possible or by the assertion of SERR_L (if enabled).</p> <p>Reset to 0</p>

BIT	FUNCTION	TYPE	DESCRIPTION
22	Secondary Interface Reset	RW	0: Do not force the assertion of RESET_L on secondary PCI bus for forward bridge, or do not generate a hot reset on the PCIe link for reverse bridge 1: Force the assertion of RESET_L on secondary PCI bus for forward bridge, or generate a hot reset on the PCIe link for reverse bridge Reset to 0
23	Fast Back-to-Back Enable	RO	Fast back-to-back not supported Reset to 0
24	Primary Master Timeout	RW	0: Primary discard timer counts 2 ¹⁵ PCI clock cycles 1: Primary discard timer counts 2 ¹⁰ PCI clock cycles FORWARD BRIDGE – Bit is RO and ignored by the PI7C9X110 Reset to 0
25	Secondary Master Timeout	RW	0: Secondary discard timer counts 2 ¹⁵ PCI clock cycles 1: Secondary discard timer counts 2 ¹⁰ PCI clock cycles REVERSE BRIDGE – Bit is RO and ignored by PI7C9X110 Reset to 0
26	Master Timeout Status	RWC	Bit is set when the discard timer expires and a delayed completion is discarded at the PCI interface for the forward or reverse bridge Reset to 0
27	Discard Timer SERR_L Enable	RW	Bit is set to enable to generate ERR_NONFATAL or ERR_FATAL for forward bridge, or assert P_SERR_L for reverse bridge as a result of the expiration of the discard timer on the PCI interface. Reset to 0
31:28	Reserved	RO	Reset to 0000

7.4.31 PCI DATA BUFFERING CONTROL REGISTER – OFFSET 40h

BIT	FUNCTION	TYPE	DESCRIPTION
0	Secondary Internal Arbiter's PARK Function	RW	0: Park to the last master 1: Park to PI7C9X110 secondary port Reset to 0
1	Memory Read Prefetching Dynamic Control Disable	RW	0: Enable memory read prefetching dynamic control for PCI to PCIe read 1: Disable memory read prefetching dynamic control for PCI to PCIe read Reset to 0
2	Completion Data Prediction Control	RW	0: Enable completion data prediction for PCI to PCIe read. 1: Disable completion data prediction Reset to 0
3	Reserved	RO	Reset to 0

BIT	FUNCTION	TYPE	DESCRIPTION
5:4	PCI Read Multiple Prefetch Mode	RW	<p>00: One cache line prefetch if memory read multiple address is in prefetchable range at the PCI interface</p> <p>01: Full prefetch if address is in prefetchable range at PCI interface, and the PI7C9X110 will keep remaining data after it disconnects the external master during burst read with read multiple command until the discard timer expires</p> <p>10: Full prefetch if address is in prefetchable range at PCI interface</p> <p>11: Full prefetch if address is in prefetchable range at PCI interface and the PI7C9X110 will keep remaining data after the read multiple is terminated either by an external master or by the PI7C9X110, until the discard time expires</p> <p>Reset to 10</p>
7:6	PCI Read Line Prefetch Mode	RW	<p>00: Once cache line prefetch if memory read address is in prefetchable range at PCI interface</p> <p>01: Full prefetch if address is in prefetchable range at PCI interface and the PI7C9X110 will keep remaining data after it is disconnected by an external master during burst read with read line command, until discard timer expires</p> <p>10: Full prefetch if memory read line address is in prefetchable range at PCI interface</p> <p>11: Full prefetch if address is in prefetchable range at PCI interface and the PI7C9X110 will keep remaining data after the read line is terminated either by an external master or by the PI7C9X110, until the discard timer expires</p> <p>Reset to 00</p>
9:8	PCI Read Prefetch Mode	RW	<p>00: One cache line prefetch if memory read address is in prefetchable range at PCI interface</p> <p>01: Reserved</p> <p>10: Full prefetch if memory read address is in prefetchable range at PCI interface</p> <p>11: Disconnect on the first DWORD</p> <p>Reset to 00</p>
10	PCI Special Delayed Read Mode Enable	RW	<p>0: Retry any master at PCI bus that repeats its transaction with command code changes.</p> <p>1: Allows any master at PCI bus to change memory command code (MR, MRL, MRM) after it has received a retry. The PI7C9X110 will complete the memory read transaction and return data back to the master if the address and byte enables are the same.</p> <p>Reset to 0</p>
11	Reserved	RO	Reset to 0
14:12	Maximum Memory Read Byte Count	RW	<p>Maximum byte count is used by the PI7C9X110 when generating memory read requests on the PCIe link in response to a memory read initiated on the PCI bus and bit [9:8], bit [7:6], and bit [5:4] are set to "full prefetch".</p> <p>000: 512 bytes (default) 001: 128 bytes 010: 256 bytes 011: 512 bytes 100: 1024 bytes 101: 2048 bytes 110: 4096 bytes 111: 512 bytes</p> <p>Reset to 000</p>

7.4.32 CHIP CONTROL 0 REGISTER – OFFSET 40h

BIT	FUNCTION	TYPE	DESCRIPTION
15	Flow Control Update Control	RW	0: Flow control is updated for every two credits available 1: Flow control is updated for every on credit available Reset to 0
16	PCI Retry Counter Status	RWC	0: The PCI retry counter has not expired since the last reset 1: The PCI retry counter has expired since the last reset Reset to 0
18:17	PCI Retry Counter Control	RW	00: No expiration limit 01: Allow 256 retries before expiration 10: Allow 64K retries before expiration 11: Allow 2G retries before expiration Reset to 00
19	PCI Discard Timer Disable	RW	0: Enable the PCI discard timer in conjunction with bit [27] offset 3Ch (bridge control register) 1: Disable the PCI discard timer in conjunction with bit [27] offset 3Ch (bridge control register) Reset to 0
20	PCI Discard Timer Short Duration	RW	0: Use bit [24] offset 3Ch for forward bridge or bit [25] offset 3Ch for reverse bridge to indicate how many PCI clocks should be allowed before the PCI discard timer expires 1: 64 PCI clocks allowed before the PCI discard timer expires Reset to 0
22:21	Configuration Request Retry Timer Counter Value Control	RW	00: Timer expires at 25us 01: Timer expires at 0.5ms 10: Timer expires at 5ms 11: Timer expires at 25ms Reset to 01
23	Delayed Transaction Order Control	RW	0: Enable out-of-order capability between delayed transactions 1: Disable out-of-order capability between delayed transactions Reset to 0
25:24	Completion Timer Counter Value Control	RW	00: Timer expires at 50us 01: Timer expires at 10ms 10: Timer expires at 50ms 11: Timer disabled Reset to 01
26	Isochronous Traffic Support Enable	RW	0: All memory transactions from PCI to PCIe will be mapped to TC0 1: All memory transactions from PCI to PCIe will be mapped to Traffic Class defined in bit [29:27] of offset 40h. Reset to 0
29:27	Traffic Class Used For Isochronous Traffic	RW	Reset to 001
30	Serial Link Interface Loopback Enable	RW / RO	0: Normal mode 1: Enable serial link interface loopback mode (TX to RX) if TM0=LOW, TM1=HIGH, TM2=HIGH, MSK_IN=HIGH, REVRSB=HIGH. PCI transaction from PCI bus will loop back to PCI bus RO for forward bridge Reset to 0

BIT	FUNCTION	TYPE	DESCRIPTION
31	Primary Configuration Access Lockout	RO / RW	0: PI7C9X110 configuration space can be accessed from both interfaces 1: PI7C9X110 configuration space can only be accessed from the secondary interface. Primary bus accessed receives completion with CRS status for forward bridge, or target retry for reverse bridge Reset to 0 if TM0 is LOW

7.4.33 RESERVED REGISTER – OFFSET 44h

BIT	FUNCTION	TYPE	DESCRIPTION
31:0	Reserved	RO	Reset to 00000000h

7.4.34 ARBITER ENABLE REGISTER – OFFSET 48h

BIT	FUNCTION	TYPE	DESCRIPTION
0	Enable Arbiter 0	RW	0: Disable arbitration for internal PI7C9X110 request 1: Enable arbitration for internal PI7C9X110 request Reset to 1
1	Enable Arbiter 1	RW	0: Disable arbitration for master 1 1: Enable arbitration for master 1 Reset to 1
2	Enable Arbiter 2	RW	0: Disable arbitration for master 2 1: Enable arbitration for master 2 Reset to 1
3	Enable Arbiter 3	RW	0: Disable arbitration for master 3 1: Enable arbitration for master 3 Reset to 1
4	Enable Arbiter 4	RW	0: Disable arbitration for master 4 1: Enable arbitration for master 4 Reset to 1
5	Enable Arbiter 5	RW	0: Disable arbitration for master 5 1: Enable arbitration for master 5 Reset to 1
6	Enable Arbiter 6	RW	0: Disable arbitration for master 6 1: Enable arbitration for master 6 Reset to 1
7	Enable Arbiter 7	RW	0: Disable arbitration for master 7 1: Enable arbitration for master 7 Reset to 1
8	Enable Arbiter 8	RW	0: Disable arbitration for master 8 1: Enable arbitration for master 8 Reset to 1

7.4.35 ARBITER MODE REGISTER – OFFSET 48h

BIT	FUNCTION	TYPE	DESCRIPTION
9	External Arbiter Bit	RO	0: Enable internal arbiter (if CFN_L is tied LOW) 1: Use external arbiter (if CFN_L is tied HIGH) Reset to 0/1 according to what CFN_L is tied to

BIT	FUNCTION	TYPE	DESCRIPTION
10	Broken Master Timeout Enable	RW	0: Broken master timeout disable 1: This bit enables the internal arbiter to count 16 PCI bus cycles while waiting for FRAME_L to become active when a device's PCI bus GNT is active and the PCI bus is idle. If the broken master timeout expires, the PCI bus GNT for the device is de-asserted. Reset to 0
11	Broken Master Refresh Enable	RW	0: A broken master will be ignored forever after de-asserting its REQ_L for at least 1 clock 1: Refresh broken master state after all the other masters have been served once Reset to 0
19:12	Arbiter Fairness Counter	RW	08h: These bits are the initialization value of a counter used by the internal arbiter. It controls the number of PCI bus cycles that the arbiter holds a device's PCI bus GNT active after detecting a PCI bus REQ_L from another device. The counter is reloaded whenever a new PCI bus GNT is asserted. For every new PCI bus GNT, the counter is armed to decrement when it detects the new fall of FRAME_L. If the arbiter fairness counter is set to 00h, the arbiter will not remove a device's PCI bus GNT until the device has de-asserted its PCI bus REQ. Reset to 08h
20	GNT_L Output Toggling Enable	RW	0: GNT_L not de-asserted after granted master assert FRAME_L 1: GNT_L de-asserts for 1 clock after 2 clocks of the granted master asserting FRAME_L Reset to 0
21	Reserved	RO	Reset to 0

7.4.36 ARBITER PRIORITY REGISTER – OFFSET 48h

BIT	FUNCTION	TYPE	DESCRIPTION
22	Arbiter Priority 0	RW	0: Low priority request to internal PI7C9X110 1: High priority request to internal PI7C9X110 Reset to 1
23	Arbiter Priority 1	RW	0: Low priority request to master 1 1: High priority request to master 1 Reset to 0
24	Arbiter Priority 2	RW	0: Low priority request to master 2 1: High priority request to master 2 Reset to 0
25	Arbiter Priority 3	RW	0: Low priority request to master 3 1: High priority request to master 3 Reset to 0
26	Arbiter Priority 4	RW	0: Low priority request to master 4 1: High priority request to master 4 Reset to 0
27	Arbiter Priority 5	RW	0: Low priority request to master 5 1: High priority request to master 5 Reset to 0
28	Arbiter Priority 6	RW	0: Low priority request to master 6 1: High priority request to master 6 Reset to 0

BIT	FUNCTION	TYPE	DESCRIPTION
29	Arbiter Priority 7	RW	0: Low priority request to master 7 1: High priority request to master 7 Reset to 0
30	Arbiter Priority 8	RW	0: Low priority request to master 8 1: High priority request to master 8 Reset to 0
31	Reserved	RO	Reset to 0

7.4.37 RESERVED REGISTERS – OFFSET 4Ch – 64h

7.4.38 EXPRESS TRANSMITTER/RECEIVER REGISTER – OFFSET 68h

BIT	FUNCTION	TYPE	DESCRIPTION
1:0	Nominal Driver Current Control	RW	00: 20mA 01: 10mA 10: 28mA 11: Reserved Reset to 00
5:2	Driver Current Scale Multiple Control	RW	0000: 1.00 x nominal driver current 0001: 1.05 x nominal driver current 0010: 1.10 x nominal driver current 0011: 1.15 x nominal driver current 0100: 1.20 x nominal driver current 0101: 1.25 x nominal driver current 0110: 1.30 x nominal driver current 0111: 1.35 x nominal driver current 1000: 0.60 x nominal driver current 1001: 0.65 x nominal driver current 1010: 0.70 x nominal driver current 1011: 0.75 x nominal driver current 1100: 0.80 x nominal driver current 1101: 0.85 x nominal driver current 1110: 0.90 x nominal driver current 1111: 0.95 x nominal driver current Reset to 0000
11:8	Driver De-emphasis Level Control	RW	0000: 0.00 db 0001: -0.35 db 0010: -0.72 db 0011: -1.11 db 0100: -1.51 db 0101: -1.94 db 0110: -2.38 db 0111: -2.85 db 1000: -3.35 db 1001: -3.88 db 1010: -4.44 db 1011: -5.04 db 1100: -5.68 db 1101: -6.38 db 1110: -7.13 db 1111: -7.96 db Reset to 1000
13:12	Transmitter Termination Control	RW	00: 52 ohms 01: 57 ohms 10: 43 ohms 11: 46 ohms Reset to 00

BIT	FUNCTION	TYPE	DESCRIPTION
15:14	Receiver Termination Control	RW	00: 52 ohms 01: 57 ohms 10: 43 ohms 11: 46 ohms Reset to 00
29:16	Reserved	RO	Reset to 00h

7.4.39 UPSTREAM MEMORY WRITE FRAGMENT CONTROL REGISTER – OFFSET 68h

BIT	FUNCTION	TYPE	DESCRIPTION
31:30	Memory Write Fragment Control	RW	Upstream Memory Write Fragment Control 00: Fragment at 32-byte boundary 01: Fragment at 64-byte boundary 1x: Fragment at 128-byte boundary Reset to 10h

7.4.40 RESERVED REGISTER – OFFSET 6Ch

7.4.41 EEPROM AUTOLOAD CONTROL/STATUS REGISTER – OFFSET 70h

BIT	FUNCTION	TYPE	DESCRIPTION
0	Initiate EEPROM Read or Write Cycle	RW	This bit will be reset to 0 after the EEPROM operation is finished. 0: EEPROM AUTOLOAD disabled 0 -> 1: Starts the EEPROM Read or Write cycle Reset to 0
1	Control Command for EEPROM	RW	0: Read 1: Write Reset to 0
2	EEPROM Error	RO	0: EEPROM acknowledge is always received during the EEPROM cycle 1: EEPROM acknowledge is not received during EEPROM cycle Reset to 0
3	EEPROM Autoload Complete Status	RO	0: EEPROM autoload is not successfully completed 1: EEPROM autoload is successfully completed Reset to 0
5:4	EEPROM Clock Frequency Control	RW	Where PCLK is 125MHz 00: PCLK / 4096 01: PCLK / 2048 10: PCLK / 1024 11: PCLK / 128 Reset to 00
6	EEPROM Autoload Control	RW	0: Enable EEPROM autoload 1: Disable EEPROM autoload Reset to 0
7	Fast EEPROM Autoload Control	RW	0: Normal speed of EEPROM autoload 1: Increase EEPROM autoload by 32x Reset to 1
8	EEPROM Autoload Status	RO	0: EEPROM autoload is not on going 1: EEPROM autoload is on going Reset to 0

BIT	FUNCTION	TYPE	DESCRIPTION
15:9	EEPROM Word Address	RW	EEPROM word address for EEPROM cycle Reset to 0000000
31:16	EEPROM Data	RW	EEPROM data to be written into the EEPROM Reset to 0000h

7.4.42 RESERVED REGISTER – OFFSET 74h

7.4.43 GPIO DATA AND CONTROL REGISTER – OFFSET 78h

BIT	FUNCTION	TYPE	DESCRIPTION
11:0	Reserved	RO	Reset to 000h
15:12	GPIO Output Write-1-to-Clear	RW	Reset to 0h
19:16	GPIO Output Write-1-to-Set	RW	Reset to 0h
23:20	GPIO Output Enable Write-1-to-Clear	RW	Reset to 0h
27:24	GPIO Output Enable Write-1-to-Set	RW	Reset to 0h
31:28	GPIO Input Data Register	RO	Reset to 0h

7.4.44 RESERVED REGISTER – OFFSET 7Ch

7.4.45 CAPABILITY ID REGISTER – OFFSET 80h

BIT	FUNCTION	TYPE	DESCRIPTION
7:0	Capability ID	RO	Capability ID Reset to 07h

7.4.46 NEXT CAPABILITY POINTER REGISTER – OFFSET 80h

BIT	FUNCTION	TYPE	DESCRIPTION
15:8	Next Capability Pointer	RO	Point to power management Reset to 90h

7.4.47 SECONDARY STATUS REGISTER – OFFSET 80h

BIT	FUNCTION	TYPE	DESCRIPTION
16	64-bit Device on Secondary Bus Interface	RO	64-bit not supported Reset to 0
17	133MHz Capable	RO	When this bit is 1, PI7C9X110 is 133MHz capable on its secondary bus interface Reset to 1 in forward bridge mode or 0 in reverse bridge mode
18	Split Completion Discarded	RO / RWC	This bit is a read-only and set to 0 in reverse bridge mode or is read-write in forward bridge mode When this is set to 1, a split completion has been discarded by PI7C9X110 at secondary bus because the requester did not accept the split completion transaction Reset to 0

BIT	FUNCTION	TYPE	DESCRIPTION
19	Unexpected Split Completion	RWC	This bit is set to 0 in forward bridge mode or is read-write in reverse bridge mode When this is set to 1, an unexpected split completion has been received with the requester ID equaled to the secondary bus number, device number, and function number at the PI7X9X110 secondary bus interface Reset to 0
20	Split Completion Overrun	RWC	When this bit is set to 1, a split completion has been terminated by PI7C9X110 with either a retry or disconnect at the next ADB due to the buffer full condition Reset to 0
21	Split Request Delayed	RWC	When this bit is set to 1, a split request is delayed because PI7C9X110 is not able to forward the split request transaction to its secondary bus due to insufficient room within the limit specified in the split transaction commitment limit field of the downstream split transaction control register Reset to 0
24:22	Secondary Clock Frequency	RO	These bits are only meaningful in forward bridge mode. In reverse bridge mode, all three bits are set to zero. 000: Conventional PCI mode (minimum clock period not applicable) 001: 66MHz (minimum clock period is 15ns) 010: 100 to 133MHz (minimum clock period is 7.5ns) 011: Reserved 1xx: Reserved Reset to 000
31:25	Reserved	RO	0000000

7.4.48 BRIDGE STATUS REGISTER – OFFSET 84h

BIT	FUNCTION	TYPE	DESCRIPTION
2:0	Function Number	RO	Function number (AD [10:8] of a type 0 configuration transaction) Reset to 000
7:3	Device Number	RO	Device number (AD [15:11] of a type 0 configuration transaction) is assigned to the PI7C9X110 by the connection of system hardware. Each time the PI7C9X110 is addressed by a configuration write transaction, the bridge updates this register with the contents of AD [15:11] of the address phase of the configuration transaction, regardless of which register in the PI7C9X110 is addressed by the transaction. The PI7C9X110 is addressed by a configuration write transaction if all of the following are true: <ul style="list-style-type: none"> The transaction uses a configuration write command IDSEL is asserted during the address phase AD [1:0] are 00 (type 0 configuration transaction) AD [10:8] of the configuration address contain the appropriate function number Reset to 11111
15:8	Bus Number	RO	Additional address from which the contents of the primary bus number register on type 1 configuration space header is read. The PI7C9X110 uses the bus number, device number, and function number fields to create a complete ID when responding with a split completion to a read of an internal PI7C9X110 register. These fields are also used for cases when one interface is in conventional PCI mode. Reset to 11111111
16	64-bit Device on Primary Bus Interface	RO	64-bit not supported Reset to 0

BIT	FUNCTION	TYPE	DESCRIPTION
17	133MHz Capable	RO	When this bit is 1, PI7C9X110 is 133MHz capable on its primary bus interface Reset to 0 in forward bridge mode or 1 in reverse bridge mode
18	Split Completion Discarded	RO / RWC	This bit is a read-only and set to 0 in reverse bridge mode or is read-write in forward bridge mode When this is set to 1, a split completion has been discarded by PI7C9X110 at primary bus because the requester did not accept the split completion transaction Reset to 0
19	Unexpected Split Completion	RWC	This bit is set to 0 in forward bridge mode or is read-write in reverse bridge mode When this is set to 1, an unexpected split completion has been received with the requester ID equaled to the primary bus number, device number, and function number at the PI7X9X110 primary bus interface Reset to 0
20	Split Completion Overrun	RWC	When this bit is set to 1, a split completion has been terminated by PI7C9X110 with either a retry or disconnect at the next ADB due to the buffer full condition Reset to 0
21	Split Request Delayed	RWC	When this bit is set to 1, a split request is delayed because PI7C9X110 is not able to forward the split request transaction to its primary bus due to insufficient room within the limit specified in the split transaction commitment limit field of the downstream split transaction control register Reset to 0
31:22	Reserved	RO	0000000000

7.4.49 UPSTREAM SPLIT TRANSACTION REGISTER – OFFSET 88h

BIT	FUNCTION	TYPE	DESCRIPTION
15:0	Upstream Split Transaction Capability	RO	Upstream Split Transaction Capability specifies the size of the buffer (in the unit of ADQs) to store split completions for memory read. It applies to the requesters on the secondary bus in addressing the completers on the primary bus. The 0010h value shows that the buffer has 16 ADQs or 2K bytes storage Reset to 0010h
31:16	Upstream Split Transaction Commitment Limit	RW	Upstream Split Transaction Commitment Limit indicates the cumulative sequence size of the commitment limit in units of ADQs. This field can be programmed to any value or equal to the content of the split capability field. For example, if the limit is set to FFFFh, PI7C9X110 is allowed to forward all split requests of any size regardless of the amount of buffer space available. The split transaction commitment limit is set to 0010h that is the same value as the split transaction capability. Reset to 0010h

7.4.50 DOWNSTREAM SPLIT TRANSACTION REGISTER – OFFSET 8Ch

BIT	FUNCTION	TYPE	DESCRIPTION
15:0	Downstream Split Transaction Capability	RO	Downstream Split Transaction Capability specifies the size of the buffer (in the unit of ADQs) to store split completions for memory read. It applies to the requesters on the primary bus in addressing the completers on the secondary bus. The 0010h value shows that the buffer has 16 ADQs or 2K bytes storage Reset to 0010h

BIT	FUNCTION	TYPE	DESCRIPTION
31:16	Downstream Split Transaction Commitment Limit	RW	Downstream Split Transaction Commitment Limit indicates the cumulative sequence size of the commitment limit in units of ADQs. This field can be programmed to any value or equal to the content of the split capability field. For example, if the limit is set to FFFFh, PI7C9X110 is allowed to forward all split requests of any size regardless of the amount of buffer space available. The split transaction commitment limit is set to 0010h that is the same value as the split transaction capability. Reset to 0010h

7.4.51 POWER MANAGEMENT ID REGISTER – OFFSET 90h

BIT	FUNCTION	TYPE	DESCRIPTION
7:0	Power Management ID	RO	Power Management ID Register Reset to 01h

7.4.52 NEXT CAPABILITY POINTER REGISTER – OFFSET 90h

BIT	FUNCTION	TYPE	DESCRIPTION
15:8	Next Pointer	RO	Next pointer (point to Subsystem ID and Subsystem Vendor ID) Reset to A8h

7.4.53 POWER MANAGEMENT CAPABILITY REGISTER – OFFSET 90h

BIT	FUNCTION	TYPE	DESCRIPTION
18:16	Version Number	RO	Version number that complies with revision 2.0 of the PCI Power Management Interface specification. Reset to 010
19	PME Clock	RO	PME clock is not required for PME_L generation Reset to 0
20	Reserved	RO	Reset to 0
21	Device Specific Initialization (DSI)	RO	DSI – no special initialization of this function beyond the standard PCI configuration header is required following transition to the D0 un-initialized state Reset to 0
24:22	AUX Current	RO	000: 0mA 001: 55mA 010: 100mA 011: 160mA 100: 220mA 101: 270mA 110: 320mA 111: 375mA Reset to 001
25	D1 Power Management	RO	D1 power management is not supported Reset to 0
26	D2 Power Management	RO	D2 power management is not supported Reset to 0
31:27	PME_L Support	RO	PME_L is supported in D3 cold, D3 hot, and D0 states. Reset to 11001

7.4.54 POWER MANAGEMENT CONTROL AND STATUS REGISTER – OFFSET 94h

BIT	FUNCTION	TYPE	DESCRIPTION
1:0	Power State	RW	Power State is used to determine the current power state of PI7C9X110. If a non-implemented state is written to this register, PI7C9X110 will ignore the write data. When present state is D3 and changing to D0 state by programming this register, the power state change causes a device reset without activating the RESET_L of PCI bus interface 00: D0 state 01: D1 state not implemented 10: D2 state not implemented 11: D3 state Reset to 00
7:2	Reserved	RO	Reset to 000000
8	PME Enable	RWS	0: PME_L assertion is disabled 1: PME_L assertion is enabled Reset to 0
12:9	Data Select	RO	Data register is not implemented Reset to 0000
14:13	Data Scale	RO	Data register is not implemented Reset to 00
15	PME Status	RWCS	PME_L is supported Reset to 0

7.4.55 PCI-TO-PCI SUPPORT EXTENSION REGISTER – OFFSET 94h

BIT	FUNCTION	TYPE	DESCRIPTION
21:16	Reserved	RO	Reset to 000000
22	B2/B3 Support	RO	0: B2 / B3 not support for D3hot Reset to 0
23	PCI Bus Power/Clock Control Enable	RO	0: PCI Bus Power/Clock Disabled Reset to 0
31:24	Data Register	RO	Data register is not implemented Reset to 00h

7.4.56 RESERVED REGISTERS – OFFSET 98h – 9Ch

7.4.57 CAPABILITY ID REGISTER – OFFSET A0h

BIT	FUNCTION	TYPE	DESCRIPTION
7:0	Capability ID	RO	Capability ID for Slot Identification. SI is off by default but can be turned on through EEPROM interface Reset to 04h

7.4.58 NEXT POINTER REGISTER – OFFSET A0h

BIT	FUNCTION	TYPE	DESCRIPTION
15:8	Next Pointer	RO	Next pointer – points to PCI Express capabilities register Reset to B0h

7.4.59 SLOT NUMBER REGISTER – OFFSET A0h

BIT	FUNCTION	TYPE	DESCRIPTION
20:16	Expansion Slot Number	RW	Expansion slot number Reset to 00000
21	First In Chassis	RW	First in chassis Reset to 0
23:22	Reserved	RO	Reset to 00

7.4.60 CHASSIS NUMBER REGISTER – OFFSET A0h

BIT	FUNCTION	TYPE	DESCRIPTION
31:24	Chassis Number	RW	Chassis number Reset to 00h

7.4.61 SECONDARY CLOCK AND CLKRUN CONTROL REGISTER – OFFSET A4h

BIT	FUNCTION	TYPE	DESCRIPTION
1:0	S_CLKOUT0 Enable	RW	S_CLKOUT (Slot 0) Enable for forward bridge mode only 00: enable S_CLKOUT0 01: enable S_CLKOUT0 10: enable S_CLKOUT0 11: disable S_CLKOUT0 and driven LOW Reset to 00
3:2	S_CLKOUT1 Enable	RW	S_CLKOUT (Slot 1) Enable for forward bridge mode only 00: enable S_CLKOUT1 01: enable S_CLKOUT1 10: enable S_CLKOUT1 11: disable S_CLKOUT1 and driven LOW Reset to 00
5:4	S_CLKOUT2 Enable	RW	S_CLKOUT (Slot 2) Enable for forward bridge mode only 00: enable S_CLKOUT2 01: enable S_CLKOUT2 10: enable S_CLKOUT2 11: disable S_CLKOUT2 and driven LOW Reset to 00
7:6	S_CLKOUT3 Enable	RW	S_CLKOUT (Slot 3) Enable for forward bridge mode only 00: enable S_CLKOUT3 01: enable S_CLKOUT3 10: enable S_CLKOUT3 11: disable S_CLKOUT3 and driven LOW Reset to 00
8	S_CLKOUT4 Enable	RW	S_CLKOUT (Device 1) Enable for forward bridge mode only 0: enable S_CLKOUT4 1: disable S_CLKOUT4 and driven LOW Reset to 0

BIT	FUNCTION	TYPE	DESCRIPTION
9	S_CLKOUT5 Enable	RW	S_CLKOUT (Device 2) Enable for forward bridge mode only 0: enable S_CLKOUT5 1: disable S_CLKOUT5 and driven LOW Reset to 0
10	S_CLKOUT6 Enable	RW	S_CLKOUT (Device 3) Enable for forward bridge mode only 0: enable S_CLKOUT6 1: disable S_CLKOUT6 and driven LOW Reset to 0
11	S_CLKOUT7 Enable	RW	S_CLKOUT (Device 4) Enable for forward bridge mode only 0: enable S_CLKOUT7 1: disable S_CLKOUT7 and driven LOW Reset to 0
12	S_CLKOUT8 Enable	RW	S_CLKOUT (the bridge) Enable for forward bridge mode only 0: enable S_CLKOUT8 1: disable S_CLKOUT8 and driven LOW Reset to 0
13	Secondary Clock Stop Status	RO	Secondary clock stop status 0: secondary clock not stopped 1: secondary clock stopped Reset to 0
14	Secondary Clkrun Protocol Enable	RW	0: disable protocol 1: enable protocol Reset to 0
15	Clkrun Mode	RW	0: Stop the secondary clock only when bridge is at D3hot state 1: Stop the secondary clock whenever the secondary bus is idle and there are no requests from the primary bus Reset to 0
31:16	Reserved	RO	Reset to 0000h

7.4.62 CAPABILITY ID REGISTER – OFFSET A8h

BIT	FUNCTION	TYPE	DESCRIPTION
7:0	Capability ID	RO	Capability ID for subsystem ID and subsystem vendor ID Reset to 0Dh

7.4.63 NEXT POINTER REGISTER – OFFSET A8h

BIT	FUNCTION	TYPE	DESCRIPTION
15:8	Next Item Pointer	RO	Next item pointer (point to PCI Express Capability by default but can be programmed to A0h if Slot Identification Capability is enabled) Reset to B0h

7.4.64 RESERVED REGISTER – OFFSET A8h

BIT	FUNCTION	TYPE	DESCRIPTION
31:16	Reserved	RO	Reset to 0000h

7.4.65 SUBSYSTEM VENDOR ID REGISTER – OFFSET ACh

BIT	FUNCTION	TYPE	DESCRIPTION
15:0	Subsystem Vendor ID	RO	Subsystem vendor ID identifies the particular add-in card or subsystem Reset to 00h

7.4.66 SUBSYSTEM ID REGISTER – OFFSET ACh

BIT	FUNCTION	TYPE	DESCRIPTION
31:16	Subsystem ID	RO	Subsystem ID identifies the particular add-in card or subsystem Reset to 00h

7.4.67 PCI EXPRESS CAPABILITY ID REGISTER – OFFSET B0h

BIT	FUNCTION	TYPE	DESCRIPTION
7:0	PCI Express Capability ID	RO	PCI Express capability ID Reset to 10h

7.4.68 NEXT CAPABILITY POINTER REGISTER – OFFSET B0h

BIT	FUNCTION	TYPE	DESCRIPTION
15:8	Next Item Pointer	RO	Next item pointer (points to VPD register) Reset to F0h

7.4.69 PCI EXPRESS CAPABILITY REGISTER – OFFSET B0h

BIT	FUNCTION	TYPE	DESCRIPTION
19:16	Capability Version	RO	Reset to 1h
23:20	Device / Port Type	RO	0000: PCI Express endpoint device 0001: Legacy PCI Express endpoint device 0100: Root port of PCI Express root complex 0101: Upstream port of PCI Express switch 0110: Downstream port of PCI Express switch 0111: PCI Express to PCI bridge 1000: PCI to PCI Express bridge Others: Reserved Reset to 7h for Forward Bridge or 8h for Reverse Bridge
24	Slot Implemented	RO	Reset to 0 for Forward Bridge or 1 for Reverse Bridge
29:25	Interrupt Message Number	RO	Reset to 0h
31:30	Reserved	RO	Reset to 0

7.4.70 DEVICE CAPABILITY REGISTER – OFFSET B4h

BIT	FUNCTION	TYPE	DESCRIPTION
2:0	Maximum Payload Size	RO	000: 128 bytes 001: 256 bytes 010: 512 bytes 011: 1024 bytes 100: 2048 bytes 101: 4096 bytes 110: reserved 111: reserved Reset to 001

BIT	FUNCTION	TYPE	DESCRIPTION
4:3	Phantom Functions	RO	No phantom functions supported Reset to 00
5	8-bit Tag Field	RO	8-bit tag field supported Reset to 1
8:6	Endpoint L0's Latency	RO	Endpoint L0's acceptable latency 000: less than 64 ns 001: 64 – 128 ns 010: 128 – 256 ns 011: 256 – 512 ns 100: 512 ns – 1 us 101: 1 – 2 us 110: 2 – 4 us 111: more than 4 us Reset to 000
11:9	Endpoint L1's Latency	RO	Endpoint L1's acceptable latency 000: less than 1 us 001: 1 – 2 us 010: 2 – 4 us 011: 4 – 8 us 100: 8 – 16 us 101: 16 – 32 us 110: 32 – 64 us 111: more than 64 us Reset to 000
12	Attention Button Present	RO	0: If Hot Plug is disabled 1: If Hot Plug is enabled at Forward Bridge Reset to 0 when hot-plug is disabled or 1 when hot-plug is enabled through strapping.
13	Attention Indicator Present	RO	0: If Hot Plug is disabled 1: If Hot Plug is enable at Forward Bridge Reset to 0 when hot-plug is disabled or 1 when hot-plug is enabled through strapping.
14	Power Indicator Present	RO	0: If Hot Plug is disabled 1: If Hot Plug is enable at Forward Bridge Reset to 0 when hot-plug is disabled or 1 when hot-plug is enabled through strapping.
17:15	Reserved	RO	Reset to 000
25:18	Captured Slot Power Limit Value	RO	These bits are set by the Set_Slot_Power_Limit message Reset to 00h
27:26	Captured Slot Power Limit Scale	RO	This value is set by the Set_Slot_Power_Limit message Reset to 00
31:28	Reserved	RO	Reset to 0h

7.4.71 DEVICE CONTROL REGISTER – OFFSET B8h

BIT	FUNCTION	TYPE	DESCRIPTION
0	Correctable Error Reporting Enable	RW	Reset to 0h
1	Non-Fatal Error Reporting Enable	RW	Reset to 0h
2	Fatal Error Reporting Enable	RW	Reset to 0h
3	Unsupported Request Reporting Enable	RW	Reset to 0h

BIT	FUNCTION	TYPE	DESCRIPTION
4	Relaxed Ordering Enable	RO	Relaxed Ordering disabled Reset to 0h
7:5	Max Payload Size	RW	This field sets the maximum TLP payload size for the PI7C9X110 000: 128 bytes 001: 256 bytes 010: 512 bytes 011: 1024 bytes 100: 2048 bytes 101: 4096 bytes 110: reserved 111: reserved Reset to 000
8	Extended Tag Field Enable	RW	Reset to 0
9	Phantom Functions Enable	RO	Phantom functions not supported Reset to 0
10	Auxiliary Power PM Enable	RO	Auxiliary power PM not supported Reset to 0
11	No Snoop Enable	RO	Bridge never sets the No Snoop attribute in the transaction it initiates Reset to 0
14:12	Maximum Read Request Size	RW	This field sets the maximum Read Request Size for the device as a requester 000: 128 bytes 001: 256 bytes 010: 512 bytes 011: 1024 bytes 100: 2048 bytes 101: 4096 bytes 110: reserved 111: reserved Reset to 2h
15	Configuration Retry Enable	RW	Reset to 0

7.4.72 DEVICE STATUS REGISTER – OFFSET B8h

BIT	FUNCTION	TYPE	DESCRIPTION
16	Correctable Error Detected	RWC	Reset to 0
17	Non-Fatal Error Detected	RWC	Reset to 0
18	Fatal Error Detected	RWC	Reset to 0
19	Unsupported Request Detected	RWC	Reset to 0
20	AUX Power Detected	RO	Reset to 1
21	Transaction Pending	RO	0: No transaction is pending on transaction layer interface 1: Transaction is pending on transaction layer interface Reset to 0
31:22	Reserved	RO	Reset to 0000000000

7.4.73 LINK CAPABILITY REGISTER – OFFSET BCh

BIT	FUNCTION	TYPE	DESCRIPTION
3:0	Maximum Link Speed	RO	Indicates the maximum speed of the Express link 0001: 2.5Gb/s link Reset to 1

BIT	FUNCTION	TYPE	DESCRIPTION
9:4	Maximum Link Width	RO	Indicates the maximum width of the Express link (x1 at reset) 000000: reserved 000001: x1 000010: x2 000100: x4 001000: x8 001100: x12 010000: x16 100000: x32 Reset to 000001
11:10	ASPM Support	RO	This field indicates the level of Active State Power Management Support 00: reserved 01: L0's entry supported 10: reserved 11: L0's and L1's supported Reset to 11
14:12	L0's Exit Latency	RO	Reset to 3h
17:15	L1's Exit Latency	RO	Reset to 0h
23:18	Reserved	RO	Reset to 0h
31:24	Port Number	RO	Reset to 00h

7.4.74 LINK CONTROL REGISTER – OFFSET C0h

BIT	FUNCTION	TYPE	DESCRIPTION
1:0	ASPM Control	RW	This field controls the level of ASPM supported on the Express link 00: disabled 01: L0's entry enabled 10: L1's entry enabled 11: L0's and L1's entry enabled Reset to 00
2	Reserved	RO	Reset to 0
3	Read Completion Boundary (RCB)	RO	Read completion boundary not supported Reset to 0
4	Link Disable	RO / RW	RO for Forward Bridge Reset to 0
5	Retrain Link	RO / RW	RO for Forward Bridge Reset to 0
6	Common Clock Configuration	RW	Reset to 0
7	Extended Sync	RW	Reset to 0
15:8	Reserved	RO	Reset to 00h

7.4.75 LINK STATUS REGISTER – OFFSET C0h

BIT	FUNCTION	TYPE	DESCRIPTION
19:16	Link Speed	RO	This field indicates the negotiated speed of the Express link 001: 2.5Gb/s link Reset to 1h

BIT	FUNCTION	TYPE	DESCRIPTION
25:20	Negotiated Link Width	RO	000000: reserved 000001: x1 000010: x2 000100: x4 001000: x8 001100: x12 010000: x16 100000: x32 Reset to 000001
26	Link Train Error	RO	Reset to 0
27	Link Training	RO	Reset to 0
28	Slot Clock Configuration	RO	Reset to 1
31:29	Reserved	RO	Reset to 0

7.4.76 SLOT CAPABILITY REGISTER – OFFSET C4h

BIT	FUNCTION	TYPE	DESCRIPTION
0	Attention Button Present	RO	0: If Hot Plug is disabled 1: If Hot Plug is enabled at reverse bridge Reset to 0 when hot-plug is disabled or 1 when hot-plug is enabled through strapping.
1	Power Controller Present	RO	Reset to 0
2	MRL Sensor Present	RO	0: If Hot Plug is disabled 1: If Hot Plug is enabled at reverse bridge Reset to 0 when hot-plug is disabled or 1 when hot-plug is enabled through strapping.
3	Attention Indicator Present	RO	0: If Hot Plug is disabled 1: If Hot Plug is enabled at reverse bridge Reset to 0 when hot-plug is disabled or 1 when hot-plug is enabled through strapping.
4	Power Indicator Present	RO	0: If Hot Plug is disabled 1: If Hot Plug is enabled at reverse bridge Reset to 0 when hot-plug is disabled or 1 when hot-plug is enabled through strapping.
5	Hot Plug Surprise	RO	Reset to 0
6	Hot Plug Capable	RO	0: If Hot Plug is disabled 1: If Hot Plug is enabled at reverse bridge Reset to 0 when hot-plug is disabled or 1 when hot-plug is enabled through strapping.
14:7	Slot Power Limit Value	RO	Reset to 00h
16:15	Slot Power Limit Scale	RO	Reset to 00
18:17	Reserved	RO	Reset to 00
31:19	Physical Slot Number	RO	Reset to 0

7.4.77 SLOT CONTROL REGISTER – OFFSET C8h

BIT	FUNCTION	TYPE	DESCRIPTION
0	Attention Button Present Enable	RW	Reset to 0
1	Power Fault Detected Enable	RW	Reset to 0
2	MRL Sensor Changed Enable	RW	Reset to 0
3	Presence Detect Changed Enable	RW	Reset to 0
4	Command Completed Interrupt Enable	RW	Reset to 0
5	Hot Plug Interrupt Enable	RW	Reset to 0

BIT	FUNCTION	TYPE	DESCRIPTION
7:6	Attention Indicator Control	RW	Reset to 0
9:8	Power Indicator Control	RW	Reset to 0
10	Power Controller Control	RW	Reset to 0
15:11	Reserved	RO	Reset to 0

7.4.78 SLOT STATUS REGISTER – OFFSET C8h

BIT	FUNCTION	TYPE	DESCRIPTION
16	Attention Button Pressed	RO	Reset to 0
17	Power Fault Detected	RO	Reset to 0
18	MRL Sensor Changed	RO	Reset to 0
19	Presence Detect Changed	RO	Reset to 0
20	Command Completed	RO	Reset to 0
21	MRL Sensor State	RO	Reset to 0
22	Presence Detect State	RO	Reset to 0
31:23	Reserved	RO	Reset to 0

7.4.79 XPIP CONFIGURATION REGISTER 0 – OFFSET CCh

BIT	FUNCTION	TYPE	DESCRIPTION
0	Hot Reset Enable	RW	Reset to 0
1	Loopback Function Enable	RW	Reset to 0
2	Cross Link Function Enable	RW	Reset to 0
3	Software Direct to Configuration State when in LTSSM state	RW	Reset to 0
4	Internal Selection for Debug Mode	RW	Reset to 0
7:5	Negotiate Lane Number of Times	RW	Reset to 3h
12:8	TS1 Number Counter	RW	Reset to 10h
15:13	Reserved	RO	Reset to 0
31:16	LTSSM Enter L1 Timer Default Value	RW	Reset to 0400h

7.4.80 XPIP CONFIGURATION REGISTER 1 – OFFSET D0h

BIT	FUNCTION	TYPE	DESCRIPTION
9:0	L0's Lifetime Timer	RW	Reset to 217h
15:10	Reserved	RO	Reset to 0
31:16	L1 Lifetime Timer	RW	Reset to 0400h

7.4.81 XPIP CONFIGURATION REGISTER 2 – OFFSET D4h

BIT	FUNCTION	TYPE	DESCRIPTION
7:0	CDR Recovery Time (in the number of FTS order sets)	RW	Reset to 54h A Fast Training Sequence order set composes of one K28.5 (COM) Symbol and three K28.1 Symbols.
14:8	L0's Exit to L0 Latency	RW	Reset to 2h
15	Reserved	RO	Reset to 0
22:16	L1 Exit to L0 Latency	RW	Reset to 19h
23	Reserved	RO	Reset to 0

7.4.82 HOT SWAP SWITCH DEBOUNCE COUNTER – OFFSET D4h

BIT	FUNCTION	TYPE	DESCRIPTION
31:24	Hot Swap Debounce Counter	RO / RW	<p>If Hot Swap is enabled, this counter is read-write able. This counter is read only (RO) if Hot Swap is disabled</p> <p>00h: 1ms 01h: 2ms 02h: 3ms 03h: 4ms ...</p> <p>FFh: 256ms</p> <p>Reset to 0</p>

7.4.83 CAPABILITY ID REGISTER – OFFSET D8h

BIT	FUNCTION	TYPE	DESCRIPTION
7:0	Capability ID for VPD Register	RO	Reset to 03h

7.4.84 NEXT POINTER REGISTER – OFFSET D8h

BIT	FUNCTION	TYPE	DESCRIPTION
15:8	Next Pointer	RO	<p>Next pointer (F0h, points to MSI capabilities)</p> <p>Reset to F0h</p>

7.4.85 VPD REGISTER – OFFSET D8h

BIT	FUNCTION	TYPE	DESCRIPTION
17:16	Reserved	RO	Reset to 0
23:18	VPD Address for Read/Write Cycle	RW	Reset to 0
30:24	Reserved	RO	Reset to 0
31	VPD Operation	RW	<p>0: Generate a read cycle from the EEPROM at the VPD address specified in bits [7:2] of offset D8h. This bit remains at '0' until EEPROM cycle is finished, after which the bit is then set to '1'. Data for reads is available at register ECh.</p> <p>1: Generate a write cycle to the EEPROM at the VPD address specified in bits [7:2] of offset D8h. This bit remains at '1' until EEPROM cycle is finished, after which it is then cleared to '0'.</p> <p>Reset to 0</p>

7.4.86 VPD DATA REGISTER – OFFSET DCh

BIT	FUNCTION	TYPE	DESCRIPTION
31:0	VPD Data	RW	<p>VPD Data (EEPROM data [address + 0x40])</p> <p>The least significant byte of this register corresponds to the byte of VPD at the address specified by the VPD address register. The data read from or written to this register uses the normal PCI byte transfer capabilities.</p> <p>Reset to 0</p>

7.4.87 RESERVED REGISTERS – OFFSET E0h – ECh

7.4.88 MESSAGE SIGNALLED INTERRUPTS ID REGISTER – F0h

BIT	FUNCTION	TYPE	DESCRIPTION
7:0	Capability ID for MSI Registers	RO	Reset to 05h

7.4.89 NEXT CAPABILITIES POINTER REGISTER – F0h

BIT	FUNCTION	TYPE	DESCRIPTION
15:8	Next Pointer	RO	Next pointer (00h indicates the end of capabilities) Reset to 00h

7.4.90 MESSAGE CONTROL REGISTER – OFFSET F0h

BIT	FUNCTION	TYPE	DESCRIPTION
16	MSI Enable	RW	0: Disable MSI and default to INTx for interrupt 1: Enable MSI for interrupt service and ignore INTx interrupt pins
19:17	Multiple Message Capable	RO	000: 1 message requested 001: 2 messages requested 010: 4 messages requested 011: 8 messages requested 100: 16 messages requested 101: 32 messages requested 110: reserved 111: reserved Reset to 000
22:20	Multiple Message Enable	RW	000: 1 message requested 001: 2 messages requested 010: 4 messages requested 011: 8 messages requested 100: 16 messages requested 101: 32 messages requested 110: reserved 111: reserved Reset to 000
23	64-bit Address Capable	RW	Reset to 1
31:24	Reserved	RO	Reset to 00h

7.4.91 MESSAGE ADDRESS REGISTER – OFFSET F4h

BIT	FUNCTION	TYPE	DESCRIPTION
1:0	Reserved	RO	Reset to 00
31:2	System Specified Message Address	RW	Reset to 0

7.4.92 MESSAGE UPPER ADDRESS REGISTER – OFFSET F8h

BIT	FUNCTION	TYPE	DESCRIPTION
31:0	System Specified Message Upper Address	RW	Reset to 0

7.4.93 MESSAGE DATA REGISTER – OFFSET FCh

BIT	FUNCTION	TYPE	DESCRIPTION
15:0	System Specified Message Data	RW	Reset to 0
31:16	Reserved	RO	Reset to 0

7.4.94 ADVANCE ERROR REPORTING CAPABILITY ID REGISTER – OFFSET 100h

BIT	FUNCTION	TYPE	DESCRIPTION
15:0	Advance Error Reporting Capability ID	RO	Reset to 0001h

7.4.95 ADVANCE ERROR REPORTING CAPABILITY VERSION REGISTER – OFFSET 100h

BIT	FUNCTION	TYPE	DESCRIPTION
19:16	Advance Error Reporting Capability Version	RO	Reset to 1h

7.4.96 NEXT CAPABILITY OFFSET REGISTER – OFFSET 100h

BIT	FUNCTION	TYPE	DESCRIPTION
31:20	Next Capability Offset	RO	Next capability offset (150h points to VC capability) Reset to 150h

7.4.97 UNCORRECTABLE ERROR STATUS REGISTER – OFFSET 104h

BIT	FUNCTION	TYPE	DESCRIPTION
0	Training Error Status	RWCS	Reset to 0
3:1	Reserved	RO	Reset to 0
4	Data Link Protocol Error Status	RWCS	Reset to 0
11:5	Reserved	RO	Reset to 0
12	Poisoned TLP Status	RWCS	Reset to 0
13	Flow Control Protocol Error Status	RWCS	Reset to 0
14	Completion Timeout Status	RWCS	Reset to 0
15	Completer Abort Status	RWCS	Reset to 0
16	Unexpected Completion Status	RWCS	Reset to 0
17	Receiver Overflow Status	RWCS	Reset to 0
18	Malformed TLP Status	RWCS	Reset to 0
19	ECRC Error Status	RWCS	Reset to 0
20	Unsupported Request Error Status	RWCS	Reset to 0
31:21	Reserved	RO	Reset to 0

7.4.98 UNCORRECTABLE ERROR MASK REGISTER – OFFSET 108h

BIT	FUNCTION	TYPE	DESCRIPTION
0	Training Error Mast	RWS	Reset to 0
3:1	Reserved	RO	Reset to 0
4	Data Link Protocol Error Mask	RWS	Reset to 0
11:5	Reserved	RO	Reset to 0
12	Poisoned TLP Mask	RWS	Reset to 0
13	Flow Control Protocol Error Mask	RWS	Reset to 0
14	Completion Timeout Mask	RWS	Reset to 0
15	Completion Abort Mask	RWS	Reset to 0
16	Unexpected Completion Mask	RWS	Reset to 0
17	Receiver Overflow Mask	RWS	Reset to 0
18	Malformed TLP Mask	RWS	Reset to 0
19	ECRC Error Mask	RWS	Reset to 0

BIT	FUNCTION	TYPE	DESCRIPTION
20	Unsupported Request Error Mask	RWS	Reset to 0
31:21	Reserved	RO	Reset to 0

7.4.99 UNCORRECTABLE ERROR SEVERITY REGISTER – OFFSET 10Ch

BIT	FUNCTION	TYPE	DESCRIPTION
0	Training Error Severity	RWS	Reset to 1
3:1	Reserved	RO	Reset to 0
4	Data Link Protocol Error Severity	RWS	Reset to 1
11:5	Reserved	RO	Reset to 0
12	Poisoned TLP Severity	RWS	Reset to 0
13	Flow Control Protocol Error Severity	RWS	Reset to 1
14	Completion Timeout Severity	RWS	Reset to 0
15	Completer Abort Severity	RWS	Reset to 0
16	Unexpected Completion Severity	RWS	Reset to 0
17	Receiver Overflow Severity	RWS	Reset to 1
18	Malformed TLP Severity	RWS	Reset to 1
19	ECRC Error Severity	RWS	Reset to 0
20	Unsupported Request Error Severity	RWS	Reset to 0
31:21	Reserved	RO	Reset to 0

7.4.100 CORRECTABLE ERROR STATUS REGISTER – OFFSET 110h

BIT	FUNCTION	TYPE	DESCRIPTION
0	Receiver Error Status	RWCS	Reset to 0
5:1	Reserved	RO	Reset to 0
6	Bad TLP Status	RWCS	Reset to 0
7	Bad DLLP Status	RWCS	Reset to 0
8	REPLAY_NUM Rollover Status	RWCS	Reset to 0
11:9	Reserved	RO	Reset to 0
12	Replay Timer Timeout Status	RWCS	Reset to 0
31:13	Reserved	RO	Reset to 0

7.4.101 CORRECTABLE ERROR MASK REGISTER – OFFSET 114h

BIT	FUNCTION	TYPE	DESCRIPTION
0	Receiver Error Mask	RWS	Reset to 0
5:1	Reserved	RO	Reset to 0
6	Bad TLP Mask	RWS	Reset to 0
7	Bad DLLP Mask	RWS	Reset to 0
8	REPLAY_NUM Rollover Mask	RWS	Reset to 0
11:9	Reserved	RO	Reset to 0
12	Replay Timer Timeout Mask	RWS	Reset to 0
31:13	Reserved	RO	Reset to 0

7.4.102 ADVANCED ERROR CAPABILITIES AND CONTROL REGISTER – OFFSET 118h

BIT	FUNCTION	TYPE	DESCRIPTION
4:0	First Error Pointer	ROS	Reset to 0h
5	ECRC Generation Capable	RO	Reset to 1
6	ECRC Generation Enable	RWS	Reset to 0

BIT	FUNCTION	TYPE	DESCRIPTION
7	ECRC Check Capable	RO	Reset to 1
8	ECRC Check Enable	RWS	Reset to 0
31:9	Reserved	RO	Reset to 0

7.4.103 HEADER LOG REGISTER 1 – OFFSET 11Ch

BIT	FUNCTION	TYPE	DESCRIPTION
7:0	Header Byte 3	ROS	Reset to 0
15:8	Header Byte 2	ROS	Reset to 0
23:16	Header Byte 1	ROS	Reset to 0
31:24	Header Byte 0	ROS	Reset to 0

7.4.104 HEADER LOG REGISTER 2 – OFFSET 120h

BIT	FUNCTION	TYPE	DESCRIPTION
7:0	Header Byte 7	ROS	Reset to 0
15:8	Header Byte 6	ROS	Reset to 0
23:16	Header Byte 5	ROS	Reset to 0
31:24	Header Byte 4	ROS	Reset to 0

7.4.105 HEADER LOG REGISTER 3 – OFFSET 124h

BIT	FUNCTION	TYPE	DESCRIPTION
7:0	Header Byte 11	ROS	Reset to 0
15:8	Header Byte 10	ROS	Reset to 0
23:16	Header Byte 9	ROS	Reset to 0
31:24	Header Byte 8	ROS	Reset to 0

7.4.106 HEADER LOG REGISTER 4 – OFFSET 128h

BIT	FUNCTION	TYPE	DESCRIPTION
7:0	Header Byte 15	ROS	Reset to 0
15:8	Header Byte 14	ROS	Reset to 0
23:16	Header Byte 13	ROS	Reset to 0
31:24	Header Byte 12	ROS	Reset to 0

7.4.107 SECONDARY UNCORRECTABLE ERROR STATUS REGISTER – OFFSET 12Ch

BIT	FUNCTION	TYPE	DESCRIPTION
0	Target Abort on Split Completion Status	RWCS	Reset to 0
1	Master Abort on Split Completion Status	RWCS	Reset to 0
2	Received Target Abort Status	RWCS	Reset to 0
3	Received Master Abort Status	RWCS	Reset to 0
4	Reserved	RO	Reset to 0
5	Unexpected Split Completion Error Status	RWCS	Reset to 0
6	Uncorrectable Split Completion Message Data Error Status	RWCS	Reset to 0
7	Uncorrectable Data Error Status	RWCS	Reset to 0
8	Uncorrectable Attribute Error Status	RWCS	Reset to 0
9	Uncorrectable Address Error Status	RWCS	Reset to 0

BIT	FUNCTION	TYPE	DESCRIPTION
10	Delayed Transaction Discard Timer Expired Status	RWCS	Reset to 0
11	PERR_L Assertion Detected Status	RWCS	Reset to 0
12	SERR_L Assertion Detected Status	RWCS	Reset to 0
13	Internal Bridge Error Status	RWCS	Reset to 0
31:14	Reserved	RO	Reset to 0

7.4.108 SECONDARY UNCORRECTABLE ERROR MASK REGISTER – OFFSET 130h

BIT	FUNCTION	TYPE	DESCRIPTION
0	Target Abort on Split Completion Mask	RWS	Reset to 0
1	Master Abort on Split Completion Mask	RWS	Reset to 0
2	Received Target Abort Mask	RWS	Reset to 0
3	Received Master Abort Mask	RWS	Reset to 1
4	Reserved	RO	Reset to 0
5	Unexpected Split Completion Error Mask	RWS	Reset to 1
6	Uncorrectable Split Completion Message Data Error Mask	RWS	Reset to 0
7	Uncorrectable Data Error Mask	RWS	Reset to 1
8	Uncorrectable Attribute Error Mask	RWS	Reset to 1
9	Uncorrectable Address Error Mask	RWS	Reset to 1
10	Delayed Transaction Discard Timer Expired Mask	RWS	Reset to 1
11	PERR_L Assertion Detected Mask	RWS	Reset to 0
12	SERR_L Assertion Detected Mask	RWS	Reset to 1
13	Internal Bridge Error Mask	RWS	Reset to 0
31:14	Reserved	RO	Reset to 0

7.4.109 SECONDARY UNCORRECTABLE ERROR SEVERITY REGISTER – OFFSET 134h

BIT	FUNCTION	TYPE	DESCRIPTION
0	Target Abort on Split Completion Severity	RWS	Reset to 0
1	Master Abort on Split Completion Severity	RWS	Reset to 0
2	Received Target Abort Severity	RWS	Reset to 0
3	Received Master Abort Severity	RWS	Reset to 0
4	Reserved	RO	Reset to 0
5	Unexpected Split Completion Error Severity	RWS	Reset to 0
6	Uncorrectable Split Completion Message Data Error Severity	RWS	Reset to 1
7	Uncorrectable Data Error Severity	RWS	Reset to 0
8	Uncorrectable Attribute Error Severity	RWS	Reset to 1
9	Uncorrectable Address Error Severity	RWS	Reset to 1

BIT	FUNCTION	TYPE	DESCRIPTION
10	Delayed Transaction Discard Timer Expired Severity	RWS	Reset to 0
11	PERR_L Assertion Detected Severity	RWS	Reset to 0
12	SERR_L Assertion Detected Severity	RWS	Reset to 1
13	Internal Bridge Error Severity	RWS	Reset to 0
31:14	Reserved	RO	Reset to 0

7.4.110 SECONDARY ERROR CAPABILITY AND CONTROL REGISTER – OFFSET 138h

BIT	FUNCTION	TYPE	DESCRIPTION
4:0	Secondary First Error Pointer	ROW	Reset to 0
31:5	Reserved	RO	Reset to 0

7.4.111 SECONDARY HEADER LOG REGISTER – OFFSET 13Ch – 148h

BIT	FUNCTION	TYPE	DESCRIPTION
35:0	Transaction Attribute	ROS	Transaction attribute, CBE [3:0] and AD [31:0] during attribute phase Reset to 0
39:36	Transaction Command Lower	ROS	Transaction command lower, CBE [3:0] during first address phase Reset to 0
43:40	Transaction Command Upper	ROS	Transaction command upper, CBE [3:0] during second address phase of DAC transaction Reset to 0
63:44	Reserved	ROS	Reset to 0
95:64	Transaction Address	ROS	Transaction address, AD [31:0] during first address phase Reset to 0
127:96	Transaction Address	ROS	Transaction address, AD [31:0] during second address phase of DAC transaction Reset to 0

7.4.112 RESERVED REGISTER – OFFSET 14Ch

7.4.113 VC CAPABILITY ID REGISTER – OFFSET 150h

BIT	FUNCTION	TYPE	DESCRIPTION
15:0	VC Capability ID	RO	Reset to 0002h

7.4.114 VC CAPABILITY VERSION REGISTER – OFFSET 150h

BIT	FUNCTION	TYPE	DESCRIPTION
19:16	VC Capability Version	RO	Reset to 1h

7.4.115 NEXT CAPABILITY OFFSET REGISTER – OFFSET 150h

BIT	FUNCTION	TYPE	DESCRIPTION
31:20	Next Capability Offset	RO	Next capability offset – the end of capabilities Reset to 0

7.4.116 PORT VC CAPABILITY REGISTER 1 – OFFSET 154h

BIT	FUNCTION	TYPE	DESCRIPTION
2:0	Extended VC Count	RO	Reset to 0
3	Reserved	RO	Reset to 0
6:4	Low Priority Extended VC Count	RO	Reset to 0
7	Reserved	RO	Reset to 0
9:8	Reference Clock	RO	Reset to 0
11:10	Port Arbitration Table Entry Size	RO	Reset to 0
31:12	Reserved	RO	Reset to 0

7.4.117 PORT VC CAPABILITY REGISTER 2 – OFFSET 158h

BIT	FUNCTION	TYPE	DESCRIPTION
7:0	VC Arbitration Capability	RO	Reset to 0
23:8	Reserved	RO	Reset to 0
31:24	VC Arbitration Table Offset	RO	Reset to 0

7.4.118 PORT VC CONTROL REGISTER – OFFSET 15Ch

BIT	FUNCTION	TYPE	DESCRIPTION
0	Load VC Arbitration Table	RO	Reset to 0
3:1	VC Arbitration Select	RO	Reset to 0
15:4	Reserved	RO	Reset to 0

7.4.119 PORT VC STATUS REGISTER – OFFSET 15Ch

BIT	FUNCTION	TYPE	DESCRIPTION
16	VC Arbitration Table Status	RO	Reset to 0
31:17	Reserved	RO	Reset to 0

7.4.120 VC0 RESOURCE CAPABILITY REGISTER – OFFSET 160h

BIT	FUNCTION	TYPE	DESCRIPTION
7:0	Port Arbitration Capability	RO	Reset to 0
13:8	Reserved	RO	Reset to 0
14	Advanced Packet Switching	RO	Reset to 0
15	Reject Snoop Transactions	RO	Reset to 0
22:16	Maximum Time Slots	RO	Reset to 0
23	Reserved	RO	Reset to 0
31:24	Port Arbitration Table Offset	RO	Reset to 0

7.4.121 VC0 RESOURCE CONTROL REGISTER – OFFSET 164h

BIT	FUNCTION	TYPE	DESCRIPTION
0	TC / VC Map	RO	For TC0 Reset to 1
7:1	TC / VC Map	RW	For TC7 to TC1 Reset to 7Fh
15:8	Reserved	RO	Reset to 0
16	Load Port Arbitration Table	RO	Reset to 0
19:17	Port Arbitration Select	RO	Reset to 0
23:20	Reserved	RO	Reset to 0
26:24	VC ID	RO	Reset to 0
30:27	Reserved	RO	Reset to 0
31	VC Enable	RO	Reset to 1

7.4.122 VC0 RESOURCE STATUS REGISTER – OFFSET 168h

BIT	FUNCTION	TYPE	DESCRIPTION
0	Port Arbitration Table 1	RO	Reset to 0
1	VC0 Negotiation Pending	RO	Reset to 0
31:2	Reserved	RO	Reset to 0

7.4.123 RESERVED REGISTERS – OFFSET 16Ch – 300h

7.4.124 EXTRA GPI/GPO DATA AND CONTROL REGISTER – OFFSET 304h

BIT	FUNCTION	TYPE	DESCRIPTION
3:0	Extra GPO	RWC	GPO [3:0], write 1 to clear Reset to 0
7:4	Extra GPO	RWS	GPO [3:0], write 1 to set Reset to 0
11:8	Extra GPO enable	RWC	GPO [3:0] enable, write 1 to clear Reset to 0
15:12	Extra GPO enable	RWS	GPO [3:0] enable, write 1 to set Reset to 0
19:16	Extra GPI	RO	Extra GPI [3:0] Data Register Reset to 0
31:20	Reserved	RO	Reset to 0

7.4.125 RESERVED REGISTERS – OFFSET 308h – 30Ch

7.4.126 REPLAY AND ACKNOWLEDGE LATENCY TIMERS – OFFSET 310h

BIT	FUNCTION	TYPE	DESCRIPTION
11:0	Replay Timer	RW	Replay Timer Reset to 20Bh
12	Replay Timer Enable	RW	Replay Timer Enable Reset to 0
15:13	Reserved	RO	Reset to 0
29:16	Acknowledge Latency Timer	RW	Acknowledge Latency Timer Reset to 127h
30	Acknowledge Latency Timer Enable	RO	Acknowledge Latency Timer Enable Reset to 0
31	Reserved	RO	Reset to 0

7.4.127 RESERVED REGISTERS – OFFSET 314h – FFCh

7.5 PCI CONFIGURATION REGISTERS FOR NON-TRANSPARENT BRIDGE MODE

The following section describes the configuration space when the device is in non-transparent bridge mode. The descriptions for different register type are listed as follow:

Register Type	Descriptions
RO	Read Only
ROS	Read Only and Sticky
RW	Read/Write
RWC	Read/Write "1" to clear
RWS	Read/Write and Sticky
RWCS	Read/Write "1" to clear and Sticky

7.5.1 VENDOR ID – OFFSET 00h

BIT	FUNCTION	TYPE	DESCRIPTION
15:0	Vendor ID	RO	Identifies Pericom as the vendor of this device. Returns 12D8h when read.

7.5.2 DEVICE ID – OFFSET 00h

BIT	FUNCTION	TYPE	DESCRIPTION
31:16	Device ID	RO	Identifies this device as the PI7C9X110. Returns E110 when read.

7.5.3 COMMAND REGISTER – OFFSET 04h

BIT	FUNCTION	TYPE	DESCRIPTION
0	I/O Space Enable	RW	0: Ignore I/O transactions on the primary interface 1: Enable response to memory transactions on the primary interface Reset to 0
1	Memory Space Enable	RW	0: Ignore memory read transactions on the primary interface 1: Enable memory read transactions on the primary interface Reset to 0
2	Bus Master Enable	RW	0: Do not initiate memory or I/O transactions on the primary interface and disable response to memory and I/O transactions on the secondary interface 1: Enable the bridge to operate as a master on the primary interfaces for memory and I/O transactions forwarded from the secondary interface. Reset to 0
3	Special Cycle Enable	RO	0: PI7C9X110 does not respond as a target to Special Cycle transactions, so this bit is defined as Read-Only and must return 0 when read Reset to 0
4	Memory Write and Invalidate Enable	RO	0: PI7C9X110 does not originate a Memory Write and Invalidate transaction. Implements this bit as Read-Only and returns 0 when read (unless forwarding a transaction for another master). Reset to 0
5	VGA Palette Snoop Enable	RO / RW	This bit applies to reverse bridge only. 0: Ignore VGA palette access on the primary 1: Enable positive decoding response to VGA palette writes on the primary interface with I/O address bits AD [9:0] equal to 3C6h, 3C8h, and 3C9h (inclusive of ISA alias; AD [15:0] are not decoded and may be any value) Reset to 0
6	Parity Error Response Enable	RW	0: May ignore any parity error that is detected and take its normal action 1: This bit if set, enables the setting of Master Data Parity Error bit in the Status Register when poisoned TLP received or parity error is detected and takes its normal action Reset to 0

BIT	FUNCTION	TYPE	DESCRIPTION
7	Wait Cycle Control	RO	Wait cycle control not supported Reset to 0
8	SERR_L Enable Bit	RW	0: Disable 1: Enable PI7C9X110 in forward bridge mode to report non-fatal or fatal error message to the Root Complex. Also, in reverse bridge mode to assert SERR_L on the primary interface Reset to 0
9	Fast Back-to-Back Enable	RO	Fast back-to-back enable not supported Reset to 0
10	Interrupt Disable	RO / RW	<u>This bit applies to reverse bridge only.</u> 0: INTA_L, INTB_L, INTC_L, and INTD_L can be asserted on PCI interface 1: Prevent INTA_L, INTB_L, INTC_L, and INTD_L from being asserted on PCI interface Reset to 0
15:11	Reserved	RO	Reset to 00000

7.5.4 PRIMARY STATUS REGISTER – OFFSET 04h

BIT	FUNCTION	TYPE	DESCRIPTION
18:16	Reserved	RO	Reset to 000
19	Primary Interrupt Status	RO	0: No INTx interrupt message request pending in PI7C9X110 primary 1: INTx interrupt message request pending in PI7C9X110 primary Reset to 0
20	Capability List Capable	RO	1: PI7C9X110 supports the capability list (offset 34h in the pointer to the data structure) Reset to 1
21	66MHz Capable	RO	<u>This bit applies to reverse bridge only.</u> 1: 66MHz capable Reset to 0 when forward bridge or 1 when reverse bridge.
22	Reserved	RO	Reset to 0
23	Fast Back-to-Back Capable	RO	<u>This bit applies to reverse bridge only.</u> 1: Enable fast back-to-back transactions Reset to 0 when forward bridge or 1 when reverse bridge with primary bus in PCI mode
24	Master Data Parity Error Detected	RWC	Bit set if its Parity Error Enable bit is set and either of the conditions occurs on the primary: FORWARD BRIDGE – <ul style="list-style-type: none"> Receives a completion marked poisoned Poisons a write request REVERSE BRIDGE – <ul style="list-style-type: none"> Detected parity error when receiving data or Split Response for read Observes P_PERR_L asserted when sending data or receiving Split Response for write Receives a Split Completion Message indicating data parity error occurred for non-posted write Reset to 0

BIT	FUNCTION	TYPE	DESCRIPTION
26:25	DEVSEL_L Timing (medium decode)	RO	These bits apply to reverse bridge only. 00: fast DEVSEL_L decoding 01: medium DEVSEL_L decoding 10: slow DEVSEL_L decoding 11: reserved Reset to 00 when forward bridge or 01 when reverse bridge.
27	Signaled Target Abort	RWC	FORWARD BRIDGE – This bit is set when PI7C9X110 completes a request using completer abort status on the primary REVERSE BRIDGE – This bit is set to indicate a target abort on the primary Reset to 0
28	Received Target Abort	RWC	FORWARD BRIDGE – This bit is set when bridge receives a completion with completer abort completion status on the primary REVERSE BRIDGE – This bit is set when PI7C9X110 detects a target abort on the primary Reset to 0
29	Received Master Abort	RWC	FORWARD BRIDGE – This bit is set when PI7C9X110 receives a completion with unsupported request completion status on the primary REVERSE BRIDGE – This bit is set when PI7C9X110 detects a master abort on the primary
30	Signaled System Error	RWC	FORWARD BRIDGE – This bit is set when PI7C9X110 sends an ERR_FATAL or ERR_NON_FATAL message on the primary REVERSE BRIDGE – This bit is set when PI7C9X110 asserts SERR_L on the primary Reset to 0
31	Detected Parity Error	RWC	FORWARD BRIDGE – This bit is set when poisoned TLP is detected on the primary REVERSE BRIDGE – This bit is set when address or data parity error is detected on the primary Reset to 0

7.5.5 REVISION ID REGISTER – OFFSET 08h

BIT	FUNCTION	TYPE	DESCRIPTION
7:0	Revision	RO	Reset to 0000002h

7.5.6 CLASS CODE REGISTER – OFFSET 08h

BIT	FUNCTION	TYPE	DESCRIPTION
15:8	Programming Interface	RO	Subtractive decoding of PCI-PCI bridge not supported Reset to 00000000
23:16	Sub-Class Code	RO	Sub-Class Code 10000000: Other bridge Reset to 10000000
31:24	Base Class Code	RO	Base class code 00000110: Bridge Device (transparent mode) Reset to 00000110 (transparent mode)

7.5.7 CACHE LINE SIZE REGISTER – OFFSET 0Ch

BIT	FUNCTION	TYPE	DESCRIPTION
1:0	Reserved	RO	Bit [1:0] not supported Reset to 00
2	Cache Line Size	RW	1: Cache line size = 4 double words Reset to 0
3	Cache Line Size	RW	1: Cache line size = 8 double words Reset to 0
4	Cache Line Size	RW	1: Cache line size = 16 double words Reset to 0
5	Cache Line Size	RW	1: Cache line size = 32 double words Reset to 0
7:6	Reserved	RO	Bit [7:6] not supported Reset to 00

7.5.8 PRIMARY LATENCY TIMER REGISTER – OFFSET 0Ch

BIT	FUNCTION	TYPE	DESCRIPTION
15:8	Primary Latency Timer	RO / RW	8 bits of primary latency timer in PCI FORWARD BRIDGE – RO with reset to 00h REVERSE BRIDGE – RW with reset to 00h in PCI mode

7.5.9 PRIMARY HEADER TYPE REGISTER – OFFSET 0Ch

BIT	FUNCTION	TYPE	DESCRIPTION
22:16	Other bridge configuration (non-transparent mode)	RO	Type-0 header format configuration (10-3Fh) Reset to 0000000 (non-transparent mode)
23	Single Function Device	RO	0: Indicates single function device Reset to 0
31:24	Reserved	RO	Reset to 00h

7.5.10 PRIMARY CSR AND MEMORY 0 BASE ADDRESS REGISTER – OFFSET 10h

BIT	FUNCTION	TYPE	DESCRIPTION
0	Space Indicator	RO	0: Memory space 1: IO space Reset to 0
2:1	Address Type	RO	00: 32-bit address decode range 01: 64-bit address decode range 10 and 11: reserved Reset to 00
3	Prefetchable control	RO	0: Memory space is non-prefetchable 1: Memory space is prefetchable Reset to 0
11:4	Reserved	RO	Reset to 0

BIT	FUNCTION	TYPE	DESCRIPTION
31:12	Base Address	RW/RO	The size and type of this Base Address Register are defined from Downstream Memory 0 Setup Register (Offset 9Ch), which can be initialized by EEPROM (I2C) or SM Bus or Local Processor. The range of this register is from 4KB to 2GB. The lower 4KB of this address range map to the PI7C9X110 CSRs into memory space. The remaining space in this range above 4KB, if any, specifies a range for forwarding downstream memory transactions. PI7X9X110 uses downstream Memory 0 Translated Base Register (Offset 98h) to formulate direct address translation. If a bit in the setup register is set to one, then the correspondent bit of this register will be changed to RW. Reset to 00000h

7.5.11 PRIMARY CSR I/O BASE ADDRESS REGISTER – OFFSET 14h

BIT	FUNCTION	TYPE	DESCRIPTION
0	Space Indicator	RO	0: Memory space 1: IO space Reset to 1
7:1	Reserved	RO	Reset to 0
31:8	Base Address	RO/RW	This Base Address Register maps to PI7C9X110 primary IO space. The maximum size is 256 bytes. Reset to 00000000h

7.5.12 DOWNSTREAM I/O OR MEMORY 1 BASE ADDRESS REGISTER – OFFSET 18h

BIT	FUNCTION	TYPE	DESCRIPTION
0	Space Indicator	RO	0: Memory space 1: IO space Reset to 0
2:1	Address Type	RO	00: 32-bit address decode range 01: 64-bit address decode range 10 and 11: reserved Reset to 00
3	Prefetchable control	RO	0: Memory space is non-prefetchable 1: Memory space is prefetchable Reset to 0
11:4	Reserved	RO	Reset to 0
31:12	Base Address	RW/RO	The size and type of this Base Address Register are defined from Downstream IO or Memory 1 Setup Register (Offset ACh), which can be initialized by EEPROM (I2C) or SM Bus or Local Processor. Writing a zero to bit [31] of the setup register to disable this register. The range of this register is from 4KB to 2GB for memory space or from 64B to 256B for IO space. PI7X9X110 uses downstream IO or Memory 1 Translated Base Register (Offset A8h) to formulate direct address translation. If a bit in the setup register is set to one, then the correspondent bit of this register will be changed to RW. Reset to 00000h

7.5.13 DOWNSTREAM MEMORY 2 BASE ADDRESS REGISTER – OFFSET 1Ch

BIT	FUNCTION	TYPE	DESCRIPTION
0	Space Indicator	RO	0: Memory space 1: IO space Reset to 0
2:1	Address Type	RO	00: 32-bit address decode range

BIT	FUNCTION	TYPE	DESCRIPTION
			01, 10 and 11: reserved Reset to 00
3	Prefetchable control	RO	0: Memory space is non-prefetchable 1: Memory space is prefetchable Reset to 0
11:4	Reserved	RO	Reset to 0
31:12	Base Address	RW/RO	The size and type of this Base Address Register are defined from Downstream Memory 2 Setup Register (CSR Offset 00Ch), which can be initialized by EEPROM (I2C) or SM Bus or Local Processor. Writing a zero to bit [31] of the setup register to disable this register. The range of this register is from 4KB to 2GB for memory space. PI7X9X110 uses downstream Memory 2 Translated Base Register (CSR Offset 008h) to formulate direct address translation. If a bit in the setup register is set to one, then the correspondent bit of this register will be changed to RW. Reset to 00000h

7.5.14 DOWNSTREAM MEMORY 3 BASE ADDRESS REGISTER – OFFSET 20h

BIT	FUNCTION	TYPE	DESCRIPTION
0	Space Indicator	RO	0: Memory space 1: IO space Reset to 0
2:1	Address Type	RO	00: 32-bit address decode range 01: 64-bit address decode range 10 and 11: reserved Reset to 00
3	Prefetchable control	RO	0: Memory space is non-prefetchable 1: Memory space is prefetchable Reset to 0
11:4	Reserved	RO	Reset to 0
31:12	Base Address	RW/RO	The size and type of this Base Address Register are defined from Downstream Memory 3 Setup Register (CSR Offset 014h), which can be initialized by EEPROM (I2C) or SM Bus or Local Processor. Writing a zero to bit [31] of the setup registers (CSR Offset 014h and 018h) to disable this register. The range of this register is from 4KB to 9EB for memory space. PI7C9X110 uses Memory 3 Translated Base Register (CSR Offset 010h) to formulate direct address translation when 32-bit addressing programmed. When 64-bit addressing programmed, no address translation is performed. If a bit in the setup register is set to one, then the correspondent bit of this register will be changed to RW. Reset to 00000h

7.5.15 DOWNSTREAM MEMORY 3 UPPER BASE ADDRESS REGISTER – OFFSET 24h

BIT	FUNCTION	TYPE	DESCRIPTION
31:0	Base address	RO/RW	The size of this Base Address Register is defined from Downstream Memory 3 Upper 32-bit Setup Register (CSR Offset 018h), which can be initialized by EEPROM (I2C) or SM Bus or Local Processor. Writing a zero to bit [31] of the setup registers (CSR Offset 018h) to disable this register. This register defines the upper 32 bits of a memory range for downstream forwarding memory. If a bit in the setup register is set to one, then the correspondent bit of this register will be changed to RW. Reset to 00000000h

7.5.16 RESERVED REGISTER – OFFSET 28h

7.5.17 SUBSYSTEM ID AND SUBSYSTEM VENDOR ID REGISTER – OFFSET 2Ch

BIT	FUNCTION	TYPE	DESCRIPTION
15:0	Subsystem Vendor ID	RO	Identify the vendor ID for add-in card or subsystem Reset to 0000h
31:16	Subsystem ID	RO	Identify the vendor specific device ID for add-in card or subsystem Reset to 0000h

7.5.18 RESERVED REGISTER – OFFSET 30h

7.5.19 CAPABILITY POINTER – OFFSET 34h

BIT	FUNCTION	TYPE	DESCRIPTION
31:8	Reserved	RO	Reset to 0
7:0	Capability Pointer	RO	Capability pointer to 80h Reset to 80h

7.5.20 EXPANSION ROM BASE ADDRESS REGISTER – OFFSET 38h

BIT	FUNCTION	TYPE	DESCRIPTION
31:0	Expansion ROM Base Address	RO	Expansion ROM not supported. Reset to 00000000h

7.5.21 PRIMARY INTERRUPT LINE REGISTER – OFFSET 3Ch

BIT	FUNCTION	TYPE	DESCRIPTION
7:0	Primary Interrupt Line	RW	<u>These bits apply to reverse bridge only.</u> For initialization code to program to tell which input of the interrupt controller the PI7C9X110's INTA_L is connected to. Reset to 00000000

7.5.22 PRIMARY INTERRUPT PIN REGISTER – OFFSET 3Ch

BIT	FUNCTION	TYPE	DESCRIPTION
15:8	Primary Interrupt Pin	RO	<u>These bits apply to reverse bridge only.</u> Designates interrupt pin INTA_L, is used Reset to 01h when forward mode and reverse mode.

7.5.23 PRIMARY MINIMUM GRANT REGISTER – OFFSET 3Ch

BIT	FUNCTION	TYPE	DESCRIPTION
23:16	Primary Minimum Grant	RO	This register is valid only in reverse bridge mode. It specifies how long of a burst period that PI7C9X110 needs on the primary bus in the units of ¼ microseconds. Reset to 0

7.5.24 PRIMARY MAXIMUM LATENCY TIME REGISTER – OFFSET 3Ch

BIT	FUNCTION	TYPE	DESCRIPTION
31:24	Primary Maximum Latency Timer	RO	This register is valid only in reverse bridge mode. It specifies how often that PI7C9X110 needs to gain access to the primary bus in units of ¼ microseconds. Reset to 0

7.5.25 PCI DATA BUFFERING CONTROL REGISTER – OFFSET 40h

BIT	FUNCTION	TYPE	DESCRIPTION
0	Secondary Internal Arbiter's PARK Function	RW	0: Park to the last master 1: Park to PI7C9X110 secondary port Reset to 0
1	Memory Read Prefetching Dynamic Control Disable	RW	0: Enable memory read prefetching dynamic control for PCI to PCIe read 1: Disable memory read prefetching dynamic control for PCI to PCIe read Reset to 0
2	Completion Data Prediction Control	RW	0: Enable completion data prediction for PCI to PCIe read. 1: Disable completion data prediction Reset to 0
3	Reserved	RO	Reset to 0
5:4	PCI Read Multiple Prefetch Mode	RW	00: One cache line prefetch if memory read multiple address is in prefetchable range at the PCI interface 01: Full prefetch if address is in prefetchable range at PCI interface, and the PI7C9X110 will keep remaining data after it disconnects the external master during burst read with read multiple command until the discard timer expires 10: Full prefetch if address is in prefetchable range at PCI interface 11: Full prefetch if address is in prefetchable range at PCI interface and the PI7C9X110 will keep remaining data after the read multiple is terminated either by an external master or by the PI7C9X110, until the discard time expires Reset to 10
7:6	PCI Read Line Prefetch Mode	RW	00: Once cache line prefetch if memory read address is in prefetchable range at PCI interface 01: Full prefetch if address is in prefetchable range at PCI interface and the PI7C9X110 will keep remaining data after it is disconnected by an external master during burst read with read line command, until discard timer expires 10: Full prefetch if memory read line address is in prefetchable range at PCI interface 11: Full prefetch if address is in prefetchable range at PCI interface and the PI7C9X110 will keep remaining data after the read line is terminated either by an external master or by the PI7C9X110, until the discard timer expires Reset to 00

BIT	FUNCTION	TYPE	DESCRIPTION
9:8	PCI Read Prefetch Mode	RW	00: One cache line prefetch if memory read address is in prefetchable range at PCI interface 01: Reserved 10: Full prefetch if memory read address is in prefetchable range at PCI interface 11: Disconnect on the first DWORD Reset to 00
10	PCI Special Delayed Read Mode Enable	RW	0: Retry any master at PCI bus that repeats its transaction with command code changes. 1: Allows any master at PCI bus to change memory command code (MR, MRL, MRM) after it has received a retry. The PI7C9X110 will complete the memory read transaction and return data back to the master if the address and byte enables are the same. Reset to 0
11	Reserved	RO	Reset to 0
14:12	Maximum Memory Read Byte Count	RW	Maximum byte count is used by the PI7C9X110 when generating memory read requests on the PCIe link in response to a memory read initiated on the PCI bus and bit [9:8], bit [7:6], and bit [5:4] are set to "full prefetch". 000: 512 bytes (default) 001: 128 bytes 010: 256 bytes 011: 512 bytes 100: 1024 bytes 101: 2048 bytes 110: 4096 bytes 111: 512 bytes Reset to 000

7.5.26 CHIP CONTROL 0 REGISTER – OFFSET 40h

BIT	FUNCTION	TYPE	DESCRIPTION
15	Flow Control Update Control	RW	0: Flow control is updated for every two credits available 1: Flow control is updated for every on credit available Reset to 0
16	PCI Retry Counter Status	RWC	0: The PCI retry counter has not expired since the last reset 1: The PCI retry counter has expired since the last reset Reset to 0
18:17	PCI Retry Counter Control	RW	00: No expiration limit 01: Allow 256 retries before expiration 10: Allow 64K retries before expiration 11: Allow 2G retries before expiration Reset to 00
19	PCI Discard Timer Disable	RW	0: Enable the PCI discard timer in conjunction with bit [27] offset 3Ch (bridge control register) 1: Disable the PCI discard timer in conjunction with bit [27] offset 3Ch (bridge control register) Reset to 0

BIT	FUNCTION	TYPE	DESCRIPTION
20	PCI Discard Timer Short Duration	RW	0: Use bit [24] offset 3Ch for forward bridge or bit [25] offset 3Ch for reverse bridge to indicate how many PCI clocks should be allowed before the PCI discard timer expires 1: 64 PCI clocks allowed before the PCI discard timer expires Reset to 0
22:21	Configuration Request Retry Timer Counter Value Control	RW	00: Timer expires at 25us 01: Timer expires at 0.5ms 10: Timer expires at 5ms 11: Timer expires at 25ms Reset to 01
23	Delayed Transaction Order Control	RW	0: Enable out-of-order capability between delayed transactions 1: Disable out-of-order capability between delayed transactions Reset to 0
25:24	Completion Timer Counter Value Control	RW	00: Timer expires at 50us 01: Timer expires at 10ms 10: Timer expires at 50ms 11: Timer disabled Reset to 01
26	Isochronous Traffic Support Enable	RW	0: All memory transactions from PCI to PCIe will be mapped to TC0 1: All memory transactions from PCI to PCIe will be mapped to Traffic Class defined in bit [29:27] of offset 40h. Reset to 0
29:27	Traffic Class Used For Isochronous Traffic	RW	Reset to 001
30	Serial Link Interface Loopback Enable	RW / RO	0: Normal mode 1: Enable serial link interface loopback mode (TX to RX) if TM0=LOW, TM1=HIGH, TM2=HIGH, MSK_IN=HIGH, REVRSB=HIGH. PCI transaction from PCI bus will loop back to PCI bus RO for forward bridge Reset to 0
31	Primary Configuration Access Lockout	RO / RW	0: PI7C9X110 configuration space can be accessed from both interfaces 1: PI7C9X110 configuration space can only be accessed from the secondary interface. Primary bus accessed receives completion with CRS status for forward bridge, or target retry for reverse bridge Reset to 0 if TM0 is LOW

7.5.27 SECONDARY COMMAND REGISTER – OFFSET 44h

BIT	FUNCTION	TYPE	DESCRIPTION
0	I/O Space Enable	RW	0: Ignore I/O transactions on the secondary interface 1: Enable response to memory transactions on the secondary interface Reset to 0
1	Memory Space Enable	RW	0: Ignore memory read transactions on the secondary interface 1: Enable memory read transactions on the secondary interface Reset to 0
2	Bus Master Enable	RW	0: Do not initiate memory or I/O transactions on the secondary interface and disable response to memory and I/O transactions on the secondary interface 1: Enable the PI7C9X110 to operate as a master on the secondary interfaces for memory and I/O transactions forwarded from the secondary interface. Reset to 0

BIT	FUNCTION	TYPE	DESCRIPTION
3	Special Cycle Enable	RO	0: Bridge does not respond as a target to Special Cycle transactions, so this bit is defined as Read-Only and must return 0 when read Reset to 0
4	Memory Write and Invalidate Enable	RO	0: PI7C9X110 does not originate a Memory Write and Invalidate transaction. Implements this bit as Read-Only and returns 0 when read (unless forwarding a transaction for another master). Reset to 0
5	VGA Palette Snoop Enable	RO	0: Ignore VGA palette snoop access on the secondary Reset to 0
6	Parity Error Response Enable	RW	0: May ignore any parity error that is detected and take its normal action 1: This bit if set, enables the setting of Master Data Parity Error bit in the Status Register when poisoned TLP received or parity error is detected and takes its normal action Reset to 0
7	Wait Cycle Control	RO	Wait cycle control not supported Reset to 0
8	Secondary SERR_L Enable Bit	RW	0: Disable 1: Enable PI7C9X110 in forward bridge mode to report non-fatal or fatal error message to the Root Complex. Also, in reverse bridge mode to assert SERR_L on the secondary interface Reset to 0
9	Fast Back-to-Back Enable	RO	Fast back-to-back enable not supported Reset to 0
10	Secondary Interrupt Disable	RO / RW	0: INTx interrupt messages can be generated 1: Prevent INTx messages to be generated and any asserted INTx interrupts will be released. Reset to 0
15:11	Reserved	RO	Reset to 00000

7.5.28 SECONDARY STATUS REGISTER – OFFSET 44h

BIT	FUNCTION	TYPE	DESCRIPTION
18:16	Reserved	RO	Reset to 000
19	Secondary Interrupt Status	RO	0: No INTx interrupt message request pending in PI7C9X110 secondary 1: INTx interrupt message request pending in PI7C9X110 secondary Reset to 0
20	Capability List Capable	RO	1: PI7C9X110 supports the capability list (offset 34h in the pointer to the data structure) Reset to 1
21	66MHz Capable	RO	<u>This bit applies to forward bridge only.</u> 1: 66MHz capable Reset to 0 when reverse bridge or 1 when forward bridge.
22	Reserved	RO	Reset to 0
23	Fast Back-to-Back Capable	RO	<u>This bit applies to forward bridge only.</u> 1: Enable fast back-to-back transactions Reset to 0 when reverse bridge or 1 when forward bridge with secondary bus in PCI mode

BIT	FUNCTION	TYPE	DESCRIPTION
24	Master Data Parity Error Detected	RWC	Bit set if its Parity Error Enable bit is set and either of the conditions occurs on the secondary: REVERSE BRIDGE – <ul style="list-style-type: none"> • Receives a completion marked poisoned • Poisons a write request FORWARD BRIDGE – <ul style="list-style-type: none"> • Detected parity error when receiving data or Split Response for read • Observes P_PERR_L asserted when sending data or receiving Split Response for write • Receives a Split Completion Message indicating data parity error occurred for non-posted write Reset to 0
26:25	DEVSEL_L Timing (medium decode)	RO	<u>These bits apply to forward bridge only.</u> 00: fast DEVSEL_L decoding 01: medium DEVSEL_L decoding 10: slow DEVSEL_L decoding 11: reserved Reset to 00 when reverse bridge or 01 when forward bridge.
27	Signaled Target Abort	RWC	REVERSE BRIDGE – This bit is set when PI7C9X110 completes a request using completer abort status on the secondary FORWARD BRIDGE – This bit is set to indicate a target abort on the secondary Reset to 0
28	Received Target Abort	RWC	REVERSE BRIDGE – This bit is set when bridge receives a completion with completer abort completion status on the secondary FORWARD BRIDGE – This bit is set when PI7C9X110 detects a target abort on the secondary Reset to 0
29	Received Master Abort	RWC	REVERSE BRIDGE – This bit is set when PI7C9X110 receives a completion with unsupported request completion status on the secondary FORWARD BRIDGE – This bit is set when PI7C9X110 detects a master abort on the secondary
30	Signaled System Error	RWC	REVERSE BRIDGE – This bit is set when PI7C9X110 sends an ERR_FATAL or ERR_NON_FATAL message on the secondary FORWARD BRIDGE – This bit is set when PI7C9X110 asserts SERR_L on the secondary Reset to 0
31	Detected Parity Error	RWC	REVERSE BRIDGE – This bit is set when poisoned TLP is detected on the secondary FORWARD BRIDGE – This bit is set when address or data parity error is detected on the secondary Reset to 0

7.5.29 ARBITER ENABLE REGISTER – OFFSET 48h

BIT	FUNCTION	TYPE	DESCRIPTION
0	Enable Arbiter 0	RW	0: Disable arbitration for internal PI7C9X110 request 1: Enable arbitration for internal PI7C9X110 request Reset to 1

BIT	FUNCTION	TYPE	DESCRIPTION
1	Enable Arbiter 1	RW	0: Disable arbitration for master 1 1: Enable arbitration for master 1 Reset to 1
2	Enable Arbiter 2	RW	0: Disable arbitration for master 2 1: Enable arbitration for master 2 Reset to 1
3	Enable Arbiter 3	RW	0: Disable arbitration for master 3 1: Enable arbitration for master 3 Reset to 1
4	Enable Arbiter 4	RW	0: Disable arbitration for master 4 1: Enable arbitration for master 4 Reset to 1
5	Enable Arbiter 5	RW	0: Disable arbitration for master 5 1: Enable arbitration for master 5 Reset to 1
6	Enable Arbiter 6	RW	0: Disable arbitration for master 6 1: Enable arbitration for master 6 Reset to 1
7	Enable Arbiter 7	RW	0: Disable arbitration for master 7 1: Enable arbitration for master 7 Reset to 1
8	Enable Arbiter 8	RW	0: Disable arbitration for master 8 1: Enable arbitration for master 8 Reset to 1

7.5.30 ARBITER MODE REGISTER – OFFSET 48h

BIT	FUNCTION	TYPE	DESCRIPTION
9	External Arbiter Bit	RO	0: Enable internal arbiter (if CFN_L is tied LOW) 1: Use external arbiter (if CFN_L is tied HIGH) Reset to 0/1 according to what CFN_L is tied to
10	Broken Master Timeout Enable	RW	0: Broken master timeout disable 1: This bit enables the internal arbiter to count 16 PCI bus cycles while waiting for FRAME_L to become active when a device's PCI bus GNT is active and the PCI bus is idle. If the broken master timeout expires, the PCI bus GNT for the device is de-asserted. Reset to 0
11	Broken Master Refresh Enable	RW	0: A broken master will be ignored forever after de-asserting its REQ_L for at least 1 clock 1: Refresh broken master state after all the other masters have been served once Reset to 0
19:12	Arbiter Fairness Counter	RW	08h: These bits are the initialization value of a counter used by the internal arbiter. It controls the number of PCI bus cycles that the arbiter holds a device's PCI bus GNT active after detecting a PCI bus REQ_L from another device. The counter is reloaded whenever a new PCI bus GNT is asserted. For every new PCI bus GNT, the counter is armed to decrement when it detects the new fall of FRAME_L. If the arbiter fairness counter is set to 00h, the arbiter will not remove a device's PCI bus GNT until the device has de-asserted its PCI bus REQ. Reset to 08h

BIT	FUNCTION	TYPE	DESCRIPTION
20	GNT_L Output Toggling Enable	RW	0: GNT_L not de-asserted after granted master assert FRAME_L 1: GNT_L de-asserts for 1 clock after 2 clocks of the granted master asserting FRAME_L Reset to 0
21	Reserved	RO	Reset to 0

7.5.31 ARBITER PRIORITY REGISTER – OFFSET 48h

BIT	FUNCTION	TYPE	DESCRIPTION
22	Arbiter Priority 0	RW	0: Low priority request to internal PI7C9X110 1: High priority request to internal PI7C9X110 Reset to 1
23	Arbiter Priority 1	RW	0: Low priority request to master 1 1: High priority request to master 1 Reset to 0
24	Arbiter Priority 2	RW	0: Low priority request to master 2 1: High priority request to master 2 Reset to 0
25	Arbiter Priority 3	RW	0: Low priority request to master 3 1: High priority request to master 3 Reset to 0
26	Arbiter Priority 4	RW	0: Low priority request to master 4 1: High priority request to master 4 Reset to 0
27	Arbiter Priority 5	RW	0: Low priority request to master 5 1: High priority request to master 5 Reset to 0
28	Arbiter Priority 6	RW	0: Low priority request to master 6 1: High priority request to master 6 Reset to 0
29	Arbiter Priority 7	RW	0: Low priority request to master 7 1: High priority request to master 7 Reset to 0
30	Arbiter Priority 8	RW	0: Low priority request to master 8 1: High priority request to master 8 Reset to 0
31	Reserved	RO	Reset to 0

7.5.32 SECONDARY CACHE LINE SIZE REGISTER – OFFSET 4Ch

BIT	FUNCTION	TYPE	DESCRIPTION
1:0	Reserved	RO	00: Cache line size of 1 DW and 2 DW are not supported Reset to 00
2	Cache Line Size	RW	1: Cache line size = 4 double words Reset to 0
3	Cache Line Size	RW	1: Cache line size = 8 double words Reset to 0

BIT	FUNCTION	TYPE	DESCRIPTION
4	Cache Line Size	RW	1: Cache line size = 16 double words Reset to 0
5	Cache Line Size	RW	1: Cache line size = 32 double words Reset to 0
7:6	Reserved	RO	Bit [7:6] not supported Reset to 00

7.5.33 SECONDARY LATENCY TIME REGISTER – OFFSET 4Ch

BIT	FUNCTION	TYPE	DESCRIPTION
15:8	Secondary Latency Timer	RO / RW	8 bits of secondary latency timer in PCI REVERSE BRIDGE – RO with reset to 00h FORWARD BRIDGE – RW with reset to 00h in PCI mode

7.5.34 SECONDARY HEADER TYPE REGISTER – OFFSET 4Ch

BIT	FUNCTION	TYPE	DESCRIPTION
22:16	Other Bridge Configuration	RO	Type-0 header format configuration (10 – 3Fh) Reset to 0000000
23	Single Function Device	RO	0: Indicates single function device Reset to 0
31:24	Reserved	RO	Reset to 00h

7.5.35 SECONDARY CSR AND MEMORY 0 BASE ADDRESS REGISTER – OFFSET 50h

BIT	FUNCTION	TYPE	DESCRIPTION
0	Space Indicator	RO	0: Memory space 1: IO space Reset to 0
2:1	Address Type	RO	00: 32-bit address decode range 01: 64-bit address decode range 10 and 11: reserved Reset to 00
3	Prefetchable control	RO	0: Memory space is non-prefetchable 1: Memory space is prefetchable Reset to 0
11:4	Reserved	RO	Reset to 0
31:12	Base Address	RW/RO	The size and type of this Base Address Register are defined from Upstream Memory 0 Setup Register (Offset E4h), which can be initialized by EEPROM (I2C) or SM Bus or Local Processor. The range of this register is from 4KB to 2GB. The lower 4KB if this address range map to the PI7C9X110 CSRs into memory space. The remaining space is this range above 4KB, if any, specifies a range for forwarding upstream memory transactions. PI7X9X110 uses upstream Memory 0 Translated Base Register (Offset E0h) to formulate direct address translation. If a bit in the setup register is set to one, then the correspondent bit of this register will be changed to RW. Reset to 00000h

7.5.36 SECONDARY CSR I/O BASE ADDRESS REGISTER – OFFSET 54h

BIT	FUNCTION	TYPE	DESCRIPTION
0	Space Indicator	RO	0: Memory space 1: IO space Reset to 1
7:1	Reserved	RO	Reset to 0
31:8	Base Address	RO/RW	This Base Address Register maps to PI7C9X110 secondary IO space. The maximum size is 256 bytes. Reset to 00000000h

7.5.37 UPSTREAM I/O OR MEMORY 1 BASE ADDRESS REGISTER – OFFSET 58h

BIT	FUNCTION	TYPE	DESCRIPTION
0	Space Indicator	RO	0: Memory space 1: IO space Reset to 0
2:1	Address Type	RO	00: 32-bit address decode range 01: 64-bit address decode range 10 and 11: reserved Reset to 00
3	Prefetchable control	RO	0: Memory space is non-prefetchable 1: Memory space is prefetchable Reset to 0
5:4	Reserved	RO	Reset to 0
31:6	Base Address	RW/RO	The size and type of this Base Address Register are defined from Upstream IO or Memory 1 Setup Register (Offset ECh), which can be initialized by EEPROM (I2C) or SM Bus or Local Processor. Writing a zero to bit [31] of the setup register to disable this register. The range of this register is from 4KB to 2GB for memory space or from 64B to 256B for IO space. PI7X9X110 uses upstream IO or Memory 1 Translated Base Register (Offset E8h) to formulate direct address translation. If a bit in the setup register is set to one, then the correspondent bit of this register will be changed to RW. Reset to 000000h

7.5.38 UPSTREAM MEMORY 2 BASE ADDRESS REGISTER – OFFSET 5Ch

BIT	FUNCTION	TYPE	DESCRIPTION
0	Space Indicator	RO	0: Memory space 1: IO space Reset to 0
2:1	Address Type	RO	00: 32-bit address decode range 01, 10 and 11: reserved Reset to 00
3	Prefetchable control	RO	0: Memory space is non-prefetchable 1: Memory space is prefetchable Reset to 0
13:4	Reserved	RO	Reset to 0

BIT	FUNCTION	TYPE	DESCRIPTION
31:14	Base Address	RW/RO	<p>This Base Address register defines the address range for upstream memory transactions. PI7C9X110 uses a lookup table to do the address translation. The address range of this register is from 16KB to 2GB in memory space. The address range is divided into 64 pages. The size of each page is defined by Memory Address Forwarding Control register (Offset 6Ah), which is initialized by EEPROM (I2C) or SM Bus or local processor. Writing a zero to the bit [0] of the look up table entry can disable the corresponding page of this register (CSR Offset 1FFh: 100h).</p> <p>The number of writeable bit may change depending on the page size setup.</p> <p>Reset to 00000h</p>

7.5.39 UPSTREAM MEMORY 3 BASE ADDRESS REGISTER – OFFSET 60h

BIT	FUNCTION	TYPE	DESCRIPTION
0	Space Indicator	RO	<p>0: Memory space 1: IO space</p> <p>Reset to 0</p>
2:1	Address Type	RO	<p>00: 32-bit address decode range 01: 64-bit address decode range 10 and 11: reserved</p> <p>Reset to 00</p>
3	Prefetchable control	RO	<p>0: Memory space is non-prefetchable 1: Memory space is prefetchable</p> <p>Reset to 0</p>
11:4	Reserved	RO	Reset to 0
31:12	Base Address	RW/RO	<p>The size and type of this Base Address Register are defined from Upstream Memory 3 Setup Register (CSR Offset 034h), which can be initialized by EEPROM (I2C) or SM Bus or Local Processor. Writing a zero to bit [31] of the setup registers (CSR Offset 034h and 038h) to disable this register. The range of this register is from 4KB to 9EB for memory space. PI7C9X110 uses this register and the Upstream Memory 3 Upper Base Address Register when 64-bit addressing programmed (bit [21] of Offset 68h). When 64-bit addressing is disabled, no address translation is performed. All 64-bit address transactions on the secondary interface falling outside of the Downstream Memory 3 address range are forwarded upstream.</p> <p>Reset to 00000h</p>

7.5.40 UPSTREAM MEMORY 3 UPPER BASE ADDRESS REGISTER – OFFSET 64h

BIT	FUNCTION	TYPE	DESCRIPTION
31:0	Base address	RO/RW	<p>The size of this Base Address Register is defined from Upstream Memory 3 Upper 32-bit Setup Register (CSR Offset 038h), which can be initialized by EEPROM (I2C) or SM Bus or Local Processor. Writing a zero to bit [31] of the setup registers (CSR Offset 038h) to disable this register. This register defines the upper 32 bits of a memory range for upstream forwarding memory. PI7C9X110 uses this register and the Upstream Memory 3 Base Address Register when 64-bit addressing programmed (bit [21] of Offset 68h). When 64-bit addressing is disabled, no address translation is performed. All 64-bit address transactions on the secondary interface falling outside of the Downstream Memory 3 address range are forwarded upstream.</p> <p>Reset to 00000000h</p>

7.5.41 EXPRESS TRANSMITTER/RECEIVER REGISTER – OFFSET 68h

BIT	FUNCTION	TYPE	DESCRIPTION
1:0	Nominal Driver Current Control	RW	00: 20mA 01: 10mA 10: 28mA 11: Reserved Reset to 00
5:2	Driver Current Scale Multiple Control	RW	0000: 1.00 x nominal driver current 0001: 1.05 x nominal driver current 0010: 1.10 x nominal driver current 0011: 1.15 x nominal driver current 0100: 1.20 x nominal driver current 0101: 1.25 x nominal driver current 0110: 1.30 x nominal driver current 0111: 1.35 x nominal driver current 1000: 0.60 x nominal driver current 1001: 0.65 x nominal driver current 1010: 0.70 x nominal driver current 1011: 0.75 x nominal driver current 1100: 0.80 x nominal driver current 1101: 0.85 x nominal driver current 1110: 0.90 x nominal driver current 1111: 0.95 x nominal driver current Reset to 0000
11:8	Driver De-emphasis Level Control	RW	0000: 0.00 db 0001: -0.35 db 0010: -0.72 db 0011: -1.11 db 0100: -1.51 db 0101: -1.94 db 0110: -2.38 db 0111: -2.85 db 1000: -3.35 db 1001: -3.88 db 1010: -4.44 db 1011: -5.04 db 1100: -5.68 db 1101: -6.38 db 1110: -7.13 db 1111: -7.96 db Reset to 1000
13:12	Transmitter Termination Control	RW	00: 52 ohms 01: 57 ohms 10: 43 ohms 11: 46 ohms Reset to 00
15:14	Receiver Termination Control	RW	00: 52 ohms 01: 57 ohms 10: 43 ohms 11: 46 ohms Reset to 00

7.5.42 MEMORY ADDRESS FORWARDING CONTROL REGISTER – OFFSET 68h

BIT	FUNCTION	TYPE	DESCRIPTION
19:16	Lookup Table Page Size	RW	<p>If bit [20] of Offset 68h is low, then</p> <p>0000: Disable Upstream Memory 2 Base Address Register 0001: 256 bytes 0010: 512 bytes 0011: 1K bytes 0100: 2K bytes 0101: 4K bytes 0110: 8K bytes 0111: 16K bytes 1000: 32K bytes 1001: 64K bytes 1010: 128K bytes 1011: 256K bytes 1100: 512K bytes 1101: 1M bytes 1110: 2M bytes 1111: 4M bytes</p> <p>If bit [20] of Offset 68h is high, then</p> <p>0000: Disable Upstream Memory 2 Base Address Register 0001: 8M bytes 0010: 16M bytes 0011: 32M bytes 01XX: Disable Upstream Memory 2 Base Address Register 1XXX: Disable Upstream Memory 2 Base Address Register</p> <p>Reset to 0h</p>
20	Lookup Table Page Size Extension	RW	<p>0: Normal Lookup Table Page Size 1: Coarse Lookup Table Page Size</p> <p>Reset to 0</p>
21	Upstream 64-bit Address Range Enable	RW	<p>0: Any 64-bit address transactions on secondary interface falling outside of Downstream Memory 3 address range are forwarded upstream 1: Enable 64-bit address transaction forwarding upstream based on Upstream Memory 3 address range without address translation</p> <p>Reset to 0</p>
29:22	Reserved	RO	Reset to 0

7.5.43 UPSTREAM MEMORY WRITE FRAGMENT CONTROL REGISTER – OFFSET 68h

BIT	FUNCTION	TYPE	DESCRIPTION
31:30	Memory Write Fragment Control	RW	<p>Upstream Memory Write Fragment Control</p> <p>00: Fragment at 32-byte boundary 01: Fragment at 64-byte boundary 1x: Fragment at 128-byte boundary</p> <p>Reset to 10h</p>

7.5.44 SUBSYSTEM VENDOR ID REGISTER – OFFSET 6Ch

BIT	FUNCTION	TYPE	DESCRIPTION
15:0	Subsystem Vendor ID	RO	<p>Subsystem vendor ID identifies the particular add-in card or subsystem.</p> <p>Reset to 00h</p>

7.5.45 SUBSYSTEM ID REGISTER – OFFSET 6Ch

BIT	FUNCTION	TYPE	DESCRIPTION
31:16	Subsystem ID	RO	Subsystem ID identifies the particular add-in card or subsystem. Reset to 00h

7.5.46 EEPROM AUTOLOAD CONTROL/STATUS REGISTER – OFFSET 70h

BIT	FUNCTION	TYPE	DESCRIPTION
0	Initiate EEPROM Read or Write Cycle	RW	This bit will be reset to 0 after the EEPROM operation is finished. 0: EEPROM AUTOLOAD disabled 0 -> 1: Starts the EEPROM Read or Write cycle Reset to 0
1	Control Command for EEPROM	RW	0: Read 1: Write Reset to 0
2	EEPROM Error	RO	0: EEPROM acknowledge is always received during the EEPROM cycle 1: EEPROM acknowledge is not received during EEPROM cycle Reset to 0
3	EEPROM Autoload Complete Status	RO	0: EEPROM autoload is not successfully completed 1: EEPROM autoload is successfully completed Reset to 0
5:4	EEPROM Clock Frequency Control	RW	Where PCLK is 125MHz 00: PCLK / 4096 01: PCLK / 2048 10: PCLK / 1024 11: PCLK / 128 Reset to 00
6	EEPROM Autoload Control	RW	0: Enable EEPROM autoload 1: Disable EEPROM autoload Reset to 0
7	Fast EEPROM Autoload Control	RW	0: Normal speed of EEPROM autoload 1: Increase EEPROM autoload by 32x Reset to 1
8	EEPROM Autoload Status	RO	0: EEPROM autoload is not on going 1: EEPROM autoload is on going Reset to 0
15:9	EEPROM Word Address	RW	EEPROM word address for EEPROM cycle Reset to 0000000
31:16	EEPROM Data	RW	EEPROM data to be written into the EEPROM Reset to 0000h

7.5.47 RESERVED REGISTER – OFFSET 74h

7.5.48 BRIDGE CONTROL AND STATUS REGISTER – OFFSET 78h

BIT	FUNCTION	TYPE	DESCRIPTION
1:0	Reserved	RO	Reset to 00

BIT	FUNCTION	TYPE	DESCRIPTION
2	SERR_L Forward Enable	RW/RO	0: Disable the forwarding of SERR_L to ERR_FATAL and ERR_NONFATAL 1: Enable the forwarding of SERR_L to ERR_FATAL and ERR_NONFATAL Reset to 0 (FORWARD BRIDGE) RO bit for REVERSE BRIDGE
3	Secondary Interface Reset	RW	0: Do not force the assertion of RESET_L on secondary PCI bus in forward bridge mode, or do not generate a hot reset on the PCI Express link in reverse bridge mode 1: Force the assertion of RESET_L on secondary PCI bus in forward bridge mode, or generate a hot reset on the PCI Express link in reverse bridge mode Reset to 0
5:4	VGA Enable	RW	00: VGA memory and I/O transactions on the primary and secondary interfaces are ignored, unless decoded by other mechanism 01: VGA memory and I/O transactions on the primary interface are forwarded to secondary interface without address translation, but VGA transactions on secondary interface are ignored 10: VGA memory and I/O transactions on the secondary interface are forwarded to primary interface without address translation, but VGA transactions on primary interface are ignored Reset to 00
6	VGA 16-bit Decode	RW	0: Execute 10-bit address decodes on VGA I/O accesses 1: Execute 16-bit address decode on VGA I/O accesses Reset to 0
7	Master Abort Mode	RW	0: Do not report master aborts (return FFFFFFFFh on reads and discards data on write) 1: Report master abort by signaling target abort if possible or by the assertion of SERR_L (if enabled). Reset to 0
8	Primary Master Timeout	RW	0: Primary discard timer counts 215 PCI clock cycles 1: Primary discard timer counts 210 PCI clock cycles FORWARD BRIDGE – Bit is RO and ignored by PI7C9X110 Reset to 0
9	Secondary Master Timeout	RW	0: Secondary discard timer counts 215 PCI clock cycles 1: Secondary discard timer counts 210 PCI clock cycles REVERSE BRIDGE – Bit is RO and ignored by PI7C9X110 Reset to 0
10	Master Timeout Status	RWC	Bit is set when the discard timer expires and a delayed completion is discarded at the PCI interface for the forward or reverse bridge Reset to 0
11	Discard Timer SERR_L Enable	RW	Bit is set to enable to generate ERR_NONFATAL or ERR_FATAL for forward bridge, or assert SERR_L for reverse bridge as a result of the expiration of the discard timer. Reset to 0

7.5.49 GPIO DATA AND CONTROL REGISTER – OFFSET 78h

BIT	FUNCTION	TYPE	DESCRIPTION
15:12	GPIO Output Write-1-to-Clear	RW	Reset to 0h
19:16	GPIO Output Write-1-to-Set	RW	Reset to 0h
23:20	GPIO Output Enable Write-1-to-Clear	RW	Reset to 0h
27:24	GPIO Output Enable Write-1-to-Set	RW	Reset to 0h
31:28	GPIO Input Data Register	RO	Reset to 0h

7.5.50 SECONDARY INTERRUPT LINE REGISTER – OFFSET 7Ch

BIT	FUNCTION	TYPE	DESCRIPTION
7:0	Secondary Interrupt Line	RW	<p>These bits apply to forward bridge only.</p> <p>For initialization code to program to tell which input of the interrupt controller the bridge's INTA_L is connected to.</p> <p>Reset to 00000000</p>

7.5.51 SECONDARY INTERRUPT PIN REGISTER – OFFSET 7Ch

BIT	FUNCTION	TYPE	DESCRIPTION
15:8	Secondary Interrupt Pin	RO	<p>These bits apply to forward bridge only.</p> <p>00000001: Designates interrupt pin INTA_L is used</p> <p>Reset to 00h when reverse mode or 01h when forward mode.</p>

7.5.52 SECONDARY MINIMUM GRANT REGISTER – OFFSET 7Ch

BIT	FUNCTION	TYPE	DESCRIPTION
23:16	Secondary Minimum Grant	RO	<p>This register is valid only in forward bridge mode. It specifies how long of a burst period that PI7C9X110 needs on the secondary bus in the units of ¼ microseconds.</p> <p>Reset to 0</p>

7.5.53 SECONDARY MAXIMUM LATENCY TIMER REGISTER – OFFSET 7Ch

BIT	FUNCTION	TYPE	DESCRIPTION
31:24	Secondary Maximum Latency Timer	RO	<p>This register is valid only in forward bridge mode. It specifies how often that PI7C9X110 needs to gain access to the primary bus in units of ¼ microseconds.</p> <p>Reset to 0</p>

7.5.54 CAPABILITY ID REGISTER – OFFSET 80h

BIT	FUNCTION	TYPE	DESCRIPTION
7:0	Capability ID	RO	<p>Capability ID</p> <p>Reset to 07h</p>

7.5.55 NEXT CAPABILITY POINTER REGISTER – OFFSET 80h

BIT	FUNCTION	TYPE	DESCRIPTION
15:8	Next Capability Pointer	RO	<p>Point to power management</p> <p>Reset to 90h</p>

7.5.56 SECONDARY STATUS REGISTER – OFFSET 80h

BIT	FUNCTION	TYPE	DESCRIPTION
16	64-bit Device on Secondary Bus Interface	RO	<p>64-bit not supported</p> <p>Reset to 0</p>

BIT	FUNCTION	TYPE	DESCRIPTION
17	133MHz Capable	RO	When this bit is 1, PI7C9X110 is 133MHz capable on its secondary bus interface Reset to 1 in forward bridge mode or 0 in reverse bridge mode
18	Split Completion Discarded	RO / RWC	This bit is a read-only and set to 0 in reverse bridge mode or is read-write in forward bridge mode When this is set to 1, a split completion has been discarded by PI7C9X110 at secondary bus because the requester did not accept the split completion transaction Reset to 0
19	Unexpected Split Completion	RWC	This bit is set to 0 in forward bridge mode or is read-write in reverse bridge mode When this is set to 1, an unexpected split completion has been received with the requester ID equaled to the secondary bus number, device number, and function number at the PI7X9X110 secondary bus interface Reset to 0
20	Split Completion Overrun	RWC	When this bit is set to 1, a split completion has been terminated by PI7C9X110 with either a retry or disconnect at the next ADB due to the buffer full condition Reset to 0
21	Split Request Delayed	RWC	When this bit is set to 1, a split request is delayed because PI7C9X110 is not able to forward the split request transaction to its secondary bus due to insufficient room within the limit specified in the split transaction commitment limit field of the downstream split transaction control register Reset to 0
24:22	Secondary Clock Frequency	RO	These bits are only meaningful in forward bridge mode. In reverse bridge mode, all three bits are set to zero. 000: Conventional PCI mode (minimum clock period not applicable) 001: 66MHz (minimum clock period is 15ns) 010: 100 to 133MHz (minimum clock period is 7.5ns) 011: Reserved 1xx: Reserved Reset to 000
31:25	Reserved	RO	0000000

7.5.57 BRIDGE STATUS REGISTER – OFFSET 84h

BIT	FUNCTION	TYPE	DESCRIPTION
2:0	Function Number	RO	Function number (AD [10:8] of a type 0 configuration transaction) Reset to 000
7:3	Device Number	RO	Device number (AD [15:11] of a type 0 configuration transaction) is assigned to the PI7C9X110 by the connection of system hardware. Each time the PI7C9X110 is addressed by a configuration write transaction, the bridge updates this register with the contents of AD [15:11] of the address phase of the configuration transaction, regardless of which register in the PI7C9X110 is addressed by the transaction. The PI7C9X110 is addressed by a configuration write transaction if all of the following are true: <ul style="list-style-type: none"> The transaction uses a configuration write command IDSEL is asserted during the address phase AD [1:0] are 00 (type 0 configuration transaction) AD [10:8] of the configuration address contain the appropriate function number Reset to 11111

BIT	FUNCTION	TYPE	DESCRIPTION
15:8	Bus Number	RO	Additional address from which the contents of the primary bus number register on type 1 configuration space header is read. The PI7C9X110 uses the bus number, device number, and function number fields to create a completer ID when responding with a split completion to a read of an internal PI7C9X110 register. These fields are also used for cases when one interface is in conventional PCI mode. Reset to 11111111
16	64-bit Device on Primary Bus Interface	RO	64-bit not supported Reset to 0
17	133MHz Capable	RO	When this bit is 1, PI7C9X110 is 133MHz capable on its primary bus interface Reset to 0 in forward bridge mode or 1 in reverse bridge mode
18	Split Completion Discarded	RO / RWC	This bit is a read-only and set to 0 in reverse bridge mode or is read-write in forward bridge mode When this is set to 1, a split completion has been discarded by PI7C9X110 at primary bus because the requester did not accept the split completion transaction Reset to 0
19	Unexpected Split Completion	RWC	This bit is set to 0 in forward bridge mode or is read-write in reverse bridge mode When this is set to 1, an unexpected split completion has been received with the requester ID equaled to the primary bus number, device number, and function number at the PI7X9X110 primary bus interface Reset to 0
20	Split Completion Overrun	RWC	When this bit is set to 1, a split completion has been terminated by PI7C9X110 with either a retry or disconnect at the next ADB due to the buffer full condition Reset to 0
21	Split Request Delayed	RWC	When this bit is set to 1, a split request is delayed because PI7C9X110 is not able to forward the split request transaction to its primary bus due to insufficient room within the limit specified in the split transaction commitment limit field of the downstream split transaction control register Reset to 0
31:22	Reserved	RO	0000000000

7.5.58 UPSTREAM SPLIT TRANSACTION REGISTER – OFFSET 88h

BIT	FUNCTION	TYPE	DESCRIPTION
15:0	Upstream Split Transaction Capability	RO	Upstream Split Transaction Capability specifies the size of the buffer (in the unit of ADQs) to store split completions for memory read. It applies to the requesters on the secondary bus in addressing the completers on the primary bus. The 0010h value shows that the buffer has 16 ADQs or 2K bytes storage Reset to 0010h
31:16	Upstream Split Transaction Commitment Limit	RW	Upstream Split Transaction Commitment Limit indicates the cumulative sequence size of the commitment limit in units of ADQs. This field can be programmed to any value or equal to the content of the split capability field. For example, if the limit is set to FFFFh, PI7C9X110 is allowed to forward all split requests of any size regardless of the amount of buffer space available. The split transaction commitment limit is set to 0010h that is the same value as the split transaction capability. Reset to 0010h

7.5.59 DOWNSTREAM SPLIT TRANSACTION REGISTER – OFFSET 8Ch

BIT	FUNCTION	TYPE	DESCRIPTION
15:0	Downstream Split Transaction Capability	RO	Downstream Split Transaction Capability specifies the size of the buffer (in the unit of ADQs) to store split completions for memory read. It applies to the requesters on the primary bus in addressing the completers on the secondary bus. The 0010h value shows that the buffer has 16 ADQs or 2K bytes storage Reset to 0010h
31:16	Downstream Split Transaction Commitment Limit	RW	Downstream Split Transaction Commitment Limit indicates the cumulative sequence size of the commitment limit in units of ADQs. This field can be programmed to any value or equal to the content of the split capability field. For example, if the limit is set to FFFFh, PI7C9X110 is allowed to forward all split requests of any size regardless of the amount of buffer space available. The split transaction commitment limit is set to 0010h that is the same value as the split transaction capability. Reset to 0010h

7.5.60 POWER MANAGEMENT ID REGISTER – OFFSET 90h

BIT	FUNCTION	TYPE	DESCRIPTION
7:0	Power Management ID	RO	Power Management ID Register Reset to 01h

7.5.61 NEXT CAPABILITY POINTER REGISTER – OFFSET 90h

BIT	FUNCTION	TYPE	DESCRIPTION
15:8	Next Pointer	RO	Next pointer (point to Subsystem ID and Subsystem Vendor ID) Reset to A8h

7.5.62 POWER MANAGEMENT CAPABILITY REGISTER – OFFSET 90h

BIT	FUNCTION	TYPE	DESCRIPTION
18:16	Version Number	RO	Version number that complies with revision 2.0 of the PCI Power Management Interface specification. Reset to 010
19	PME Clock	RO	PME clock is not required for PME_L generation Reset to 0
20	Reserved	RO	Reset to 0
21	Device Specific Initialization (DSI)	RO	DSI – no special initialization of this function beyond the standard PCI configuration header is required following transition to the D0 un-initialized state Reset to 0
24:22	AUX Current	RO	000: 0mA 001: 55mA 010: 100mA 011: 160mA 100: 220mA 101: 270mA 110: 320mA 111: 375mA Reset to 001
25	D1 Power Management	RO	D1 power management is not supported Reset to 0

BIT	FUNCTION	TYPE	DESCRIPTION
26	D2 Power Management	RO	D2 power management is not supported Reset to 0
31:27	PME_L Support	RO	PME_L is supported in D3 cold, D3 hot, and D0 states. Reset to 11001

7.5.63 POWER MANAGEMENT CONTROL AND STATUS REGISTER – OFFSET 94h

BIT	FUNCTION	TYPE	DESCRIPTION
1:0	Power State	RW	Power State is used to determine the current power state of PI7C9X110. If a non-implemented state is written to this register, PI7C9X110 will ignore the write data. When present state is D3 and changing to D0 state by programming this register, the power state change causes a device reset without activating the RESET_L of PCI bus interface 00: D0 state 01: D1 state not implemented 10: D2 state not implemented 11: D3 state Reset to 00
7:2	Reserved	RO	Reset to 000000
8	PME Enable	RWS	0: PME_L assertion is disabled 1: PME_L assertion is enabled Reset to 0
12:9	Data Select	RO	Data register is not implemented Reset to 0000
14:13	Data Scale	RO	Data register is not implemented Reset to 00
15	PME Status	RWCS	PME_L is supported Reset to 0

7.5.64 PCI-TO-PCI SUPPORT EXTENSION REGISTER – OFFSET 94h

BIT	FUNCTION	TYPE	DESCRIPTION
21:16	Reserved	RO	Reset to 000000
22	B2/B3 Support	RO	0: B2 / B3 not support for D3hot Reset to 0
23	PCI Bus Power/Clock Control Enable	RO	0: PCI Bus Power/Clock Disabled Reset to 0
31:24	Data Register	RO	Data register is not implemented Reset to 00h

7.5.65 DOWNSTREAM MEMORY 0 TRANSLATED BASE REGISTER – OFFSET 98h

BIT	FUNCTION	TYPE	DESCRIPTION
11:0	Reserved	RO	Reset to 000h
31:12	Downstream Memory 0 Translated Base	RW	Define the translated base address for downstream memory transactions whose initiator addresses fall into Downstream Memory 0 (above lower 4K boundary) address range. The number of bits that are used for translated base is determined by its setup register (offset 9Ch) Reset to 00000h

7.5.66 DOWNSTREAM MEMORY 0 SETUP REGISTER – OFFSET 9Ch

BIT	FUNCTION	TYPE	DESCRIPTION
0	Type Selector	RO	0: Memory space is requested Reset to 0
2:1	Address Type	RO (WS)	00: 32-bit address space 01: 64-bit address space Reset to 00
3	Prefetchable Control	RO (WS)	0: Non-prefetchable 1: Prefetchable Reset to 0
11:4	Reserved	RO	Reset to 00h
30:12	Base Address Register Size	RO (WS)	0: Set the corresponding bit in the Base Address Register to read only. 1: Set the corresponding bit in the Base Address Register to read/write in order to control the size of the address range. Reset to 7FFFFh
31	Base Address Register Enable	RO (WS)	Always set to 1 when a bus master attempts to write a zero to this bit. PI7C9X110 returns bit [31:12] as FFFFFh (for 4KB size). Reset to 1

7.5.67 CAPABILITY ID REGISTER – OFFSET A0h

BIT	FUNCTION	TYPE	DESCRIPTION
7:0	Capability ID	RO	Capability ID for Slot Identification. SI is off by default but can be turned on through EEPROM interface Reset to 04h

7.5.68 NEXT POINTER REGISTER – OFFSET A0h

BIT	FUNCTION	TYPE	DESCRIPTION
15:8	Next Pointer	RO	Next pointer – points to PCI Express capabilities register Reset to B0h

7.5.69 SLOT NUMBER REGISTER – OFFSET A0h

BIT	FUNCTION	TYPE	DESCRIPTION
20:16	Expansion Slot Number	RW	Expansion slot number Reset to 00000
21	First In Chassis	RW	First in chassis Reset to 0
23:22	Reserved	RO	Reset to 00

7.5.70 CHASSIS NUMBER REGISTER – OFFSET A0h

BIT	FUNCTION	TYPE	DESCRIPTION
31:24	Chassis Number	RW	Chassis number Reset to 00h

7.5.71 SECONDARY CLOCK AND CLKRUN CONTROL REGISTER – OFFSET A4h

BIT	FUNCTION	TYPE	DESCRIPTION
1:0	S_CLKOUT0 Enable	RW	S_CLKOUT (Slot 0) Enable for forward bridge mode only 00: enable S_CLKOUT0 01: enable S_CLKOUT0 10: enable S_CLKOUT0 11: disable S_CLKOUT0 and driven LOW Reset to 00
3:2	S_CLKOUT1 Enable	RW	S_CLKOUT (Slot 1) Enable for forward bridge mode only 00: enable S_CLKOUT1 01: enable S_CLKOUT1 10: enable S_CLKOUT1 11: disable S_CLKOUT1 and driven LOW Reset to 00
5:4	S_CLKOUT2 Enable	RW	S_CLKOUT (Slot 2) Enable for forward bridge mode only 00: enable S_CLKOUT2 01: enable S_CLKOUT2 10: enable S_CLKOUT2 11: disable S_CLKOUT2 and driven LOW Reset to 00
7:6	S_CLKOUT3 Enable	RW	S_CLKOUT (Slot 3) Enable for forward bridge mode only 00: enable S_CLKOUT3 01: enable S_CLKOUT3 10: enable S_CLKOUT3 11: disable S_CLKOUT3 and driven LOW Reset to 00
8	S_CLKOUT4 Enable	RW	S_CLKOUT (Device 1) Enable for forward bridge mode only 0: enable S_CLKOUT4 1: disable S_CLKOUT4 and driven LOW Reset to 0
9	S_CLKOUT5 Enable	RW	S_CLKOUT (Device 2) Enable for forward bridge mode only 0: enable S_CLKOUT5 1: disable S_CLKOUT5 and driven LOW Reset to 0
10	S_CLKOUT6 Enable	RW	S_CLKOUT (Device 3) Enable for forward bridge mode only 0: enable S_CLKOUT6 1: disable S_CLKOUT6 and driven LOW Reset to 0
11	S_CLKOUT7 Enable	RW	S_CLKOUT (Device 4) Enable for forward bridge mode only 0: enable S_CLKOUT7 1: disable S_CLKOUT7 and driven LOW Reset to 0
12	S_CLKOUT8 Enable	RW	S_CLKOUT (the bridge) Enable for forward bridge mode only 0: enable S_CLKOUT8 1: disable S_CLKOUT8 and driven LOW Reset to 0

BIT	FUNCTION	TYPE	DESCRIPTION
13	Secondary Clock Stop Status	RO	Secondary clock stop status 0: secondary clock not stopped 1: secondary clock stopped Reset to 0
14	Secondary Clkrun Protocol Enable	RW	0: disable protocol 1: enable protocol Reset to 0
15	Clkrun Mode	RW	0: Stop the secondary clock only when bridge is at D3hot state 1: Stop the secondary clock whenever the secondary bus is idle and there are no requests from the primary bus Reset to 0
31:16	Reserved	RO	Reset to 0000h

7.5.72 DOWNSTREAM I/O OR MEMORY 1 TRANSLATED BASE REGISTER – OFFSET A8h

BIT	FUNCTION	TYPE	DESCRIPTION
5:0	Reserved	RO	Reset to 000000
31:6	Downstream I/O or Memory 1 Translated Base	RW	Define the translated base address for downstream I/O or memory transactions whose initiator addresses fall into Downstream I/O or Memory 1 address range. The number of bits that are used for translated base is determined by its setup register (offset ACh) Reset to 00000h

7.5.73 DOWSTREAM I/O OR MEMORY 1 SETUP REGISTER – OFFSET ACh

BIT	FUNCTION	TYPE	DESCRIPTION
0	Type Selector	RO	0: Memory space is requested Reset to 0
2:1	Address Type	RO (WS)	00: 32-bit address space 01: 64-bit address space Reset to 00
3	Prefetchable Control	RO (WS)	0: Non-prefetchable 1: Prefetchable Reset to 0
5:4	Reserved	RO	Reset to 00
30:6	Base Address Register Size	RO (WS)	0: Set the corresponding bit in the Base Address Register to read only. 1: Set the corresponding bit in the Base Address Register to read/write in order to control the size of the address range. If memory space is selected, bit [11:6] should be set to zeros. Reset to 00000000h
31	Base Address Register Enable	RO (WS)	0: Disable this Base Address Register 1: Enable this Base Address Register Reset to 0

7.5.74 PCI EXPRESS CAPABILITY ID REGISTER – OFFSET B0h

BIT	FUNCTION	TYPE	DESCRIPTION
7:0	PCI Express Capability ID	RO	PCI Express capability ID Reset to 10h

7.5.75 NEXT CAPABILITY POINTER REGISTER – OFFSET B0h

BIT	FUNCTION	TYPE	DESCRIPTION
15:8	Next Item Pointer	RO	Next item pointer (points to VPD register) Reset to F0h

7.5.76 PCI EXPRESS CAPABILITY REGISTER – OFFSET B0h

BIT	FUNCTION	TYPE	DESCRIPTION
19:16	Capability Version	RO	Reset to 1h
23:20	Device / Port Type	RO	0000: PCI Express endpoint device 0001: Legacy PCI Express endpoint device 0100: Root port of PCI Express root complex 0101: Upstream port of PCI Express switch 0110: Downstream port of PCI Express switch 0111: PCI Express to PCI bridge 1000: PCI to PCI Express bridge Others: Reserved Reset to 7h for Forward Bridge or 8h for Reverse Bridge
24	Slot Implemented	RO	Reset to 0 for Forward Bridge or 1 for Reverse Bridge
29:25	Interrupt Message Number	RO	Reset to 0h
31:30	Reserved	RO	Reset to 0

7.5.77 DEVICE CAPABILITY REGISTER – OFFSET B4h

BIT	FUNCTION	TYPE	DESCRIPTION
2:0	Maximum Payload Size	RO	000: 128 bytes 001: 256 bytes 010: 512 bytes 011: 1024 bytes 100: 2048 bytes 101: 4096 bytes 110: reserved 111: reserved Reset to 001
4:3	Phantom Functions	RO	No phantom functions supported Reset to 00
5	8-bit Tag Field	RO	8-bit tag field supported Reset to 1
8:6	Endpoint L0's Latency	RO	Endpoint L0's acceptable latency 000: less than 64 ns 001: 64 – 128 ns 010: 128 – 256 ns 011: 256 – 512 ns 100: 512 ns – 1 us 101: 1 – 2 us 110: 2 – 4 us 111: more than 4 us Reset to 000

BIT	FUNCTION	TYPE	DESCRIPTION
11:9	Endpoint L1's Latency	RO	Endpoint L1's acceptable latency 000: less than 1 us 001: 1 – 2 us 010: 2 – 4 us 011: 4 – 8 us 100: 8 – 16 us 101: 16 – 32 us 110: 32 – 64 us 111: more than 64 us Reset to 000
12	Attention Button Present	RO	0: If Hot Plug is disabled 1: If Hot Plug is enabled at Forward Bridge Reset to 0 when hot-plug is disabled or 1 when hot-plug is enabled through strapping.
13	Attention Indicator Present	RO	0: If Hot Plug is disabled 1: If Hot Plug is enable at Forward Bridge Reset to 0 when hot-plug is disabled or 1 when hot-plug is enabled through strapping.
14	Power Indicator Present	RO	0: If Hot Plug is disabled 1: If Hot Plug is enable at Forward Bridge Reset to 0 when hot-plug is disabled or 1 when hot-plug is enabled through strapping.
17:15	Reserved	RO	Reset to 000
25:18	Captured Slot Power Limit Value	RO	These bits are set by the Set_Slot_Power_Limit message Reset to 00h
27:26	Captured Slot Power Limit Scale	RO	This value is set by the Set_Slot_Power_Limit message Reset to 00
31:28	Reserved	RO	Reset to 0h

7.5.78 DEVICE CONTROL REGISTER – OFFSET B8h

BIT	FUNCTION	TYPE	DESCRIPTION
0	Correctable Error Reporting Enable	RW	Reset to 0h
1	Non-Fatal Error Reporting Enable	RW	Reset to 0h
2	Fatal Error Reporting Enable	RW	Reset to 0h
3	Unsupported Request Reporting Enable	RW	Reset to 0h
4	Relaxed Ordering Enable	RO	Relaxed Ordering disabled Reset to 0h
7:5	Max Payload Size	RW	This field sets the maximum TLP payload size for the PI7C9X110 000: 128 bytes 001: 256 bytes 010: 512 bytes 011: 1024 bytes 100: 2048 bytes 101: 4096 bytes 110: reserved 111: reserved Reset to 000
8	Extended Tag Field Enable	RW	Reset to 0
9	Phantom Functions Enable	RO	Phantom functions not supported Reset to 0

BIT	FUNCTION	TYPE	DESCRIPTION
10	Auxiliary Power PM Enable	RO	Auxiliary power PM not supported Reset to 0
11	No Snoop Enable	RO	Bridge never sets the No Snoop attribute in the transaction it initiates Reset to 0
14:12	Maximum Read Request Size	RW	This field sets the maximum Read Request Size for the device as a requester 000: 128 bytes 001: 256 bytes 010: 512 bytes 011: 1024 bytes 100: 2048 bytes 101: 4096 bytes 110: reserved 111: reserved Reset to 2h
15	Configuration Retry Enable	RW	Reset to 0

7.5.79 DEVICE STATUS REGISTER – OFFSET B8h

BIT	FUNCTION	TYPE	DESCRIPTION
16	Correctable Error Detected	RWC	Reset to 0
17	Non-Fatal Error Detected	RWC	Reset to 0
18	Fatal Error Detected	RWC	Reset to 0
19	Unsupported Request Detected	RWC	Reset to 0
20	AUX Power Detected	RO	Reset to 1
21	Transaction Pending	RO	0: No transaction is pending on transaction layer interface 1: Transaction is pending on transaction layer interface Reset to 0
31:22	Reserved	RO	Reset to 0000000000

7.5.80 LINK CAPABILITY REGISTER – OFFSET BCh

BIT	FUNCTION	TYPE	DESCRIPTION
3:0	Maximum Link Speed	RO	Indicates the maximum speed of the Express link 0001: 2.5Gb/s link Reset to 1
9:4	Maximum Link Width	RO	Indicates the maximum width of the Express link (x1 at reset) 000000: reserved 000001: x1 000010: x2 000100: x4 001000: x8 001100: x12 010000: x16 100000: x32 Reset to 000001
11:10	ASPM Support	RO	This field indicates the level of Active State Power Management Support 00: reserved 01: L0's entry supported 10: reserved 11: L0's and L1's supported Reset to 11
14:12	L0's Exit Latency	RO	Reset to 3h

BIT	FUNCTION	TYPE	DESCRIPTION
17:15	L1's Exit Latency	RO	Reset to 0h
23:18	Reserved	RO	Reset to 0h
31:24	Port Number	RO	Reset to 00h

7.5.81 LINK CONTROL REGISTER – OFFSET C0h

BIT	FUNCTION	TYPE	DESCRIPTION
1:0	ASPM Control	RW	This field controls the level of ASPM supported on the Express link 00: disabled 01: L0's entry enabled 10: L1's entry enabled 11: L0's and L1's entry enabled Reset to 00
2	Reserved	RO	Reset to 0
3	Read Completion Boundary (RCB)	RO	Read completion boundary not supported Reset to 0
4	Link Disable	RO / RW	RO for Forward Bridge Reset to 0
5	Retrain Link	RO / RW	RO for Forward Bridge Reset to 0
6	Common Clock Configuration	RW	Reset to 0
7	Extended Sync	RW	Reset to 0
15:8	Reserved	RO	Reset to 00h

7.5.82 LINK STATUS REGISTER – OFFSET C0h

BIT	FUNCTION	TYPE	DESCRIPTION
19:16	Link Speed	RO	This field indicates the negotiated speed of the Express link 001: 2.5Gb/s link Reset to 1h
25:20	Negotiated Link Width	RO	000000: reserved 000001: x1 000010: x2 000100: x4 001000: x8 001100: x12 010000: x16 100000: x32 Reset to 000001
26	Link Train Error	RO	Reset to 0
27	Link Training	RO	Reset to 0
28	Slot Clock Configuration	RO	Reset to 1
31:29	Reserved	RO	Reset to 0

7.5.83 SLOT CAPABILITY REGISTER – OFFSET C4h

BIT	FUNCTION	TYPE	DESCRIPTION
0	Attention Button Present	RO	0: If Hot Plug is disabled 1: If Hot Plug is enabled at reverse bridge Reset to 0 when hot-plug is disabled or 1 when hot-plug is enabled through strapping.
1	Power Controller Present	RO	Reset to 0

BIT	FUNCTION	TYPE	DESCRIPTION
2	MRL Sensor Present	RO	0: If Hot Plug is disabled 1: If Hot Plug is enabled at reverse bridge Reset to 0 when hot-plug is disabled or 1 when hot-plug is enabled through strapping.
3	Attention Indicator Present	RO	0: If Hot Plug is disabled 1: If Hot Plug is enabled at reverse bridge Reset to 0 when hot-plug is disabled or 1 when hot-plug is enabled through strapping.
4	Power Indicator Present	RO	0: If Hot Plug is disabled 1: If Hot Plug is enabled at reverse bridge Reset to 0 when hot-plug is disabled or 1 when hot-plug is enabled through strapping.
5	Hot Plug Surprise	RO	Reset to 0
6	Hot Plug Capable	RO	0: If Hot Plug is disabled 1: If Hot Plug is enabled at reverse bridge Reset to 0 when hot-plug is disabled or 1 when hot-plug is enabled through strapping.
14:7	Slot Power Limit Value	RO	Reset to 00h
16:15	Slot Power Limit Scale	RO	Reset to 00
18:17	Reserved	RO	Reset to 00
31:19	Physical Slot Number	RO	Reset to 0

7.5.84 SLOT CONTROL REGISTER – OFFSET C8h

BIT	FUNCTION	TYPE	DESCRIPTION
0	Attention Button Present Enable	RW	Reset to 0
1	Power Fault Detected Enable	RW	Reset to 0
2	MRL Sensor Changed Enable	RW	Reset to 0
3	Presence Detect Changed Enable	RW	Reset to 0
4	Command Completed Interrupt Enable	RW	Reset to 0
5	Hot Plug Interrupt Enable	RW	Reset to 0
7:6	Attention Indicator Control	RW	Reset to 0
9:8	Power Indicator Control	RW	Reset to 0
10	Power Controller Control	RW	Reset to 0
15:11	Reserved	RO	Reset to 0

7.5.85 SLOT STATUS REGISTER – OFFSET C8h

BIT	FUNCTION	TYPE	DESCRIPTION
16	Attention Button Pressed	RO	Reset to 0
17	Power Fault Detected	RO	Reset to 0
18	MRL Sensor Changed	RO	Reset to 0
19	Presence Detect Changed	RO	Reset to 0
20	Command Completed	RO	Reset to 0
21	MRL Sensor State	RO	Reset to 0
22	Presence Detect State	RO	Reset to 0
31:23	Reserved	RO	Reset to 0

7.5.86 XPIP CONFIGURATION REGISTER 0 – OFFSET CCh

BIT	FUNCTION	TYPE	DESCRIPTION
0	Hot Reset Enable	RW	Reset to 0
1	Loopback Function Enable	RW	Reset to 0
2	Cross Link Function Enable	RW	Reset to 0

BIT	FUNCTION	TYPE	DESCRIPTION
3	Software Direct to Configuration State when in LTSSM state	RW	Reset to 0
4	Internal Selection for Debug Mode	RW	Reset to 0
7:5	Negotiate Lane Number of Times	RW	Reset to 3h
12:8	TS1 Number Counter	RW	Reset to 10h
15:13	Reserved	RO	Reset to 0
31:16	LTSSM Enter L1 Timer Default Value	RW	Reset to 0400h

7.5.87 XPIP CONFIGURATION REGISTER 1 – OFFSET D0h

BIT	FUNCTION	TYPE	DESCRIPTION
9:0	L0's Lifetime Timer	RW	Reset to 217h
15:10	Reserved	RO	Reset to 0
31:16	L1 Lifetime Timer	RW	Reset to 0400h

7.5.88 XPIP CONFIGURATION REGISTER 2 – OFFSET D4h

BIT	FUNCTION	TYPE	DESCRIPTION
7:0	CDR Recovery Time (in the number of FTS order sets)	RW	Reset to 54h A Fast Training Sequence order set composes of one K28.5 (COM) Symbol and three K28.1 Symbols.
14:8	L0's Exit to L0 Latency	RW	Reset to 2h
15	Reserved	RO	Reset to 0
22:16	L1 Exit to L0 Latency	RW	Reset to 19h
31:23	Reserved	RO	Reset to 0

7.5.89 CAPABILITY ID REGISTER – OFFSET D8h

BIT	FUNCTION	TYPE	DESCRIPTION
7:0	Capability ID for VPD Register	RO	Reset to 03h

7.5.90 NEXT POINTER REGISTER – OFFSET D8h

BIT	FUNCTION	TYPE	DESCRIPTION
15:8	Next Pointer	RO	Next pointer (F0h, points to MSI capabilities) Reset to F0h

7.5.91 VPD REGISTER – OFFSET D8h

BIT	FUNCTION	TYPE	DESCRIPTION
17:16	Reserved	RO	Reset to 0
23:18	VPD Address for Read/Write Cycle	RW	Reset to 0
30:24	Reserved	RO	Reset to 0
31	VPD Operation	RW	0: Generate a read cycle from the EEPROM at the VPD address specified in bits [7:2] of offset D8h. This bit remains at '0' until EEPROM cycle is finished, after which the bit is then set to '1'. Data for reads is available at register ECh. 1: Generate a write cycle to the EEPROM at the VPD address specified in bits [7:2] of offset D8h. This bit remains at '1' until EEPROM cycle is finished, after which it is then cleared to '0'. Reset to 0

7.5.92 VPD DATA REGISTER – OFFSET DCh

BIT	FUNCTION	TYPE	DESCRIPTION
31:0	VPD Data	RW	VPD Data (EEPROM data [address + 0x40]) The least significant byte of this register corresponds to the byte of VPD at the address specified by the VPD address register. The data read from or written to this register uses the normal PCI byte transfer capabilities. Reset to 0

7.5.93 UPSTREAM MEMORY 0 TRANSLATED BASE REGISTER – OFFSET E0h

BIT	FUNCTION	TYPE	DESCRIPTION
11:0	Reserved	RO	Reset to 000h
31:12	Downstream Memory 0 Translated Base	RW	Define the translated base address for upstream memory transactions whose initiator addresses fall into Upstream Memory 0 (above lower 4K boundary) address range. The number of bits that are used for translated base is determined by its setup register (offset E4h) Reset to 00000h

7.5.94 UPSTREAM MEMORY 0 SETUP REGISTER – OFFSET E4h

BIT	FUNCTION	TYPE	DESCRIPTION
0	Type Selector	RO	0: Memory space is requested Reset to 0
2:1	Address Type	RO (WS)	00: 32-bit address space 01: 64-bit address space Reset to 00
3	Prefetchable Control	RO (WS)	0: Non-prefetchable 1: Prefetchable Reset to 0
11:4	Reserved	RO	Reset to 00h
30:12	Base Address Register Size	RO (WS)	0: Set the corresponding bit in the Base Address Register to read only. 1: Set the corresponding bit in the Base Address Register to read/write in order to control the size of the address range. Reset to 00000h
31	Base Address Register Enable	RO (WS)	Always set to 1 when a bus master attempts to write a zero to this bit. PI7C9X110 returns bit [31:12] as FFFFh (for 4KB size). Reset to 1

7.5.95 UPSTREAM I/O OR MEMORY 1 TRANSLATED BASE REGISTER – OFFSET E8h

BIT	FUNCTION	TYPE	DESCRIPTION
5:0	Reserved	RO	Reset to 000000
31:6	Upstream I/O or Memory 1 Translated Base	RW	Define the translated base address for upstream I/O or memory transactions whose initiator addresses fall into Upstream I/O or Memory 1 address range. The number of bits that are used for translated base is determined by its setup register (offset ECh) Reset to 00000h

7.5.96 UPSTREAM I/O OR MEMORY 1 SETUP REGISTER – OFFSET ECh

BIT	FUNCTION	TYPE	DESCRIPTION
0	Type Selector	RO	0: Memory space is requested Reset to 0
2:1	Address Type	RO (WS)	00: 32-bit address space 01: 64-bit address space Reset to 00
3	Prefetchable Control	RO (WS)	0: Non-prefetchable 1: Prefetchable Reset to 0
5:4	Reserved	RO	Reset to 00
30:6	Base Address Register Size	RO (WS)	0: Set the corresponding bit in the Base Address Register to read only. 1: Set the corresponding bit in the Base Address Register to read/write in order to control the size of the address range. If memory space is selected, bit [11:6] should be set to zeros. Reset to 00000000h
31	Base Address Register Enable	RO (WS)	0: Disable this Base Address Register 1: Enable this Base Address Register Reset to 0

7.5.97 MESSAGE SIGNALLED INTERRUPTS ID REGISTER – F0h

BIT	FUNCTION	TYPE	DESCRIPTION
7:0	Capability ID for MSI Registers	RO	Reset to 05h

7.5.98 NEXT CAPABILITIES POINTER REGISTER – F0h

BIT	FUNCTION	TYPE	DESCRIPTION
15:8	Next Pointer	RO	Next pointer (00h indicates the end of capabilities) Reset to 00h

7.5.99 MESSAGE CONTROL REGISTER – OFFSET F0h

BIT	FUNCTION	TYPE	DESCRIPTION
16	MSI Enable	RW	0: Disable MSI and default to INTx for interrupt 1: Enable MSI for interrupt service and ignore INTx interrupt pins
19:17	Multiple Message Capable	RO	000: 1 message requested 001: 2 messages requested 010: 4 messages requested 011: 8 messages requested 100: 16 messages requested 101: 32 messages requested 110: reserved 111: reserved Reset to 000

BIT	FUNCTION	TYPE	DESCRIPTION
22:20	Multiple Message Enable	RW	000: 1 message requested 001: 2 messages requested 010: 4 messages requested 011: 8 messages requested 100: 16 messages requested 101: 32 messages requested 110: reserved 111: reserved Reset to 000
23	64-bit Address Capable	RW	Reset to 1
31:24	Reserved	RO	Reset to 00h

7.5.100 MESSAGE ADDRESS REGISTER – OFFSET F4h

BIT	FUNCTION	TYPE	DESCRIPTION
1:0	Reserved	RO	Reset to 00
31:2	System Specified Message Address	RW	Reset to 0

7.5.101 MESSAGE UPPER ADDRESS REGISTER – OFFSET F8h

BIT	FUNCTION	TYPE	DESCRIPTION
31:0	System Specified Message Upper Address	RW	Reset to 0

7.5.102 MESSAGE DATA REGISTER – OFFSET FCh

BIT	FUNCTION	TYPE	DESCRIPTION
15:0	System Specified Message Data	RW	Reset to 0
31:16	Reserved	RO	Reset to 0

7.5.103 ADVANCE ERROR REPORTING CAPABILITY ID REGISTER – OFFSET 100h

BIT	FUNCTION	TYPE	DESCRIPTION
15:0	Advance Error Reporting Capability ID	RO	Reset to 0001h

7.5.104 ADVANCE ERROR REPORTING CAPABILITY VERSION REGISTER – OFFSET 100h

BIT	FUNCTION	TYPE	DESCRIPTION
19:16	Advance Error Reporting Capability Version	RO	Reset to 1h

7.5.105 NEXT CAPABILITY OFFSET REGISTER – OFFSET 100h

BIT	FUNCTION	TYPE	DESCRIPTION
31:20	Next Capability Offset	RO	Next capability offset (150h points to VC capability) Reset to 150h

7.5.106 UNCORRECTABLE ERROR STATUS REGISTER – OFFSET 104h

BIT	FUNCTION	TYPE	DESCRIPTION
0	Training Error Status	RWCS	Reset to 0
3:1	Reserved	RO	Reset to 0
4	Data Link Protocol Error Status	RWCS	Reset to 0

BIT	FUNCTION	TYPE	DESCRIPTION
11:5	Reserved	RO	Reset to 0
12	Poisoned TLP Status	RWCS	Reset to 0
13	Flow Control Protocol Error Status	RWCS	Reset to 0
14	Completion Timeout Status	RWCS	Reset to 0
15	Completer Abort Status	RWCS	Reset to 0
16	Unexpected Completion Status	RWCS	Reset to 0
17	Receiver Overflow Status	RWCS	Reset to 0
18	Malformed TLP Status	RWCS	Reset to 0
19	ECRC Error Status	RWCS	Reset to 0
20	Unsupported Request Error Status	RWCS	Reset to 0
31:21	Reserved	RO	Reset to 0

7.5.107 UNCORRECTABLE ERROR MASK REGISTER – OFFSET 108h

BIT	FUNCTION	TYPE	DESCRIPTION
0	Training Error Mast	RWS	Reset to 0
3:1	Reserved	RO	Reset to 0
4	Data Link Protocol Error Mask	RWS	Reset to 0
11:5	Reserved	RO	Reset to 0
12	Poisoned TLP Mask	RWS	Reset to 0
13	Flow Control Protocol Error Mask	RWS	Reset to 0
14	Completion Timeout Mask	RWS	Reset to 0
15	Completion Abort Mask	RWS	Reset to 0
16	Unexpected Completion Mask	RWS	Reset to 0
17	Receiver Overflow Mask	RWS	Reset to 0
18	Malformed TLP Mask	RWS	Reset to 0
19	ECRC Error Mask	RWS	Reset to 0
20	Unsupported Request Error Mask	RWS	Reset to 0
31:21	Reserved	RO	Reset to 0

7.5.108 UNCORRECTABLE ERROR SEVERITY REGISTER – OFFSET 10Ch

BIT	FUNCTION	TYPE	DESCRIPTION
0	Training Error Severity	RWS	Reset to 1
3:1	Reserved	RO	Reset to 0
4	Data Link Protocol Error Severity	RWS	Reset to 1
11:5	Reserved	RO	Reset to 0
12	Poisoned TLP Severity	RWS	Reset to 0
13	Flow Control Protocol Error Severity	RWS	Reset to 1
14	Completion Timeout Severity	RWS	Reset to 0
15	Completer Abort Severity	RWS	Reset to 0
16	Unexpected Completion Severity	RWS	Reset to 0
17	Receiver Overflow Severity	RWS	Reset to 1
18	Malformed TLP Severity	RWS	Reset to 1
19	ECRC Error Severity	RWS	Reset to 0
20	Unsupported Request Error Severity	RWS	Reset to 0
31:21	Reserved	RO	Reset to 0

7.5.109 CORRECTABLE ERROR STATUS REGISTER – OFFSET 110h

BIT	FUNCTION	TYPE	DESCRIPTION
0	Receiver Error Status	RWCS	Reset to 0
5:1	Reserved	RO	Reset to 0
6	Bad TLP Status	RWCS	Reset to 0
7	Bad DLLP Status	RWCS	Reset to 0
8	REPLAY_NUM Rollover Status	RWCS	Reset to 0
11:9	Reserved	RO	Reset to 0
12	Replay Timer Timeout Status	RWCS	Reset to 0
31:13	Reserved	RO	Reset to 0

7.5.110 CORRECTABLE ERROR MASK REGISTER – OFFSET 114h

BIT	FUNCTION	TYPE	DESCRIPTION
0	Receiver Error Mask	RWS	Reset to 0
5:1	Reserved	RO	Reset to 0
6	Bad TLP Mask	RWS	Reset to 0
7	Bad DLLP Mask	RWS	Reset to 0
8	REPLAY_NUM Rollover Mask	RWS	Reset to 0
11:9	Reserved	RO	Reset to 0
12	Replay Timer Timeout Mask	RWS	Reset to 0
31:13	Reserved	RO	Reset to 0

7.5.111 ADVANCED ERROR CAPABILITIES AND CONTROL REGISTER – OFFSET 118h

BIT	FUNCTION	TYPE	DESCRIPTION
4:0	First Error Pointer	ROS	Reset to 0h
5	ECRC Generation Capable	RO	Reset to 1
6	ECRC Generation Enable	RWS	Reset to 0
7	ECRC Check Capable	RO	Reset to 1
8	ECRC Check Enable	RWS	Reset to 0
31:9	Reserved	RO	Reset to 0

7.5.112 HEADER LOG REGISTER 1 – OFFSET 11Ch

BIT	FUNCTION	TYPE	DESCRIPTION
7:0	Header Byte 3	ROS	Reset to 0
15:8	Header Byte 2	ROS	Reset to 0
23:16	Header Byte 1	ROS	Reset to 0
31:24	Header Byte 0	ROS	Reset to 0

7.5.113 HEADER LOG REGISTER 2 – OFFSET 120h

BIT	FUNCTION	TYPE	DESCRIPTION
7:0	Header Byte 7	ROS	Reset to 0
15:8	Header Byte 6	ROS	Reset to 0
23:16	Header Byte 5	ROS	Reset to 0
31:24	Header Byte 4	ROS	Reset to 0

7.5.114 HEADER LOG REGISTER 3 – OFFSET 124h

BIT	FUNCTION	TYPE	DESCRIPTION
7:0	Header Byte 11	ROS	Reset to 0
15:8	Header Byte 10	ROS	Reset to 0
23:16	Header Byte 9	ROS	Reset to 0
31:24	Header Byte 8	ROS	Reset to 0

7.5.115 HEADER LOG REGISTER 4 – OFFSET 128h

BIT	FUNCTION	TYPE	DESCRIPTION
7:0	Header Byte 15	ROS	Reset to 0
15:8	Header Byte 14	ROS	Reset to 0
23:16	Header Byte 13	ROS	Reset to 0
31:24	Header Byte 12	ROS	Reset to 0

7.5.116 SECONDARY UNCORRECTABLE ERROR STATUS REGISTER – OFFSET 12Ch

BIT	FUNCTION	TYPE	DESCRIPTION
0	Target Abort on Split Completion Status	RWCS	Reset to 0
1	Master Abort on Split Completion Status	RWCS	Reset to 0
2	Received Target Abort Status	RWCS	Reset to 0
3	Received Master Abort Status	RWCS	Reset to 0
4	Reserved	RO	Reset to 0
5	Unexpected Split Completion Error Status	RWCS	Reset to 0
6	Uncorrectable Split Completion Message Data Error Status	RWCS	Reset to 0
7	Uncorrectable Data Error Status	RWCS	Reset to 0
8	Uncorrectable Attribute Error Status	RWCS	Reset to 0
9	Uncorrectable Address Error Status	RWCS	Reset to 0
10	Delayed Transaction Discard Timer Expired Status	RWCS	Reset to 0
11	PERR_L Assertion Detected Status	RWCS	Reset to 0
12	SERR_L Assertion Detected Status	RWCS	Reset to 0
13	Internal Bridge Error Status	RWCS	Reset to 0
31:14	Reserved	RO	Reset to 0

7.5.117 SECONDARY UNCORRECTABLE ERROR MASK REGISTER – OFFSET 130h

BIT	FUNCTION	TYPE	DESCRIPTION
0	Target Abort on Split Completion Mask	RWS	Reset to 0
1	Master Abort on Split Completion Mask	RWS	Reset to 0
2	Received Target Abort Mask	RWS	Reset to 0
3	Received Master Abort Mask	RWS	Reset to 1
4	Reserved	RO	Reset to 0
5	Unexpected Split Completion Error Mask	RWS	Reset to 1
6	Uncorrectable Split Completion Message Data Error Mask	RWS	Reset to 0
7	Uncorrectable Data Error Mask	RWS	Reset to 1
8	Uncorrectable Attribute Error Mask	RWS	Reset to 1
9	Uncorrectable Address Error Mask	RWS	Reset to 1

BIT	FUNCTION	TYPE	DESCRIPTION
10	Delayed Transaction Discard Timer Expired Mask	RWS	Reset to 1
11	PERR_L Assertion Detected Mask	RWS	Reset to 0
12	SERR_L Assertion Detected Mask	RWS	Reset to 1
13	Internal Bridge Error Mask	RWS	Reset to 0
31:14	Reserved	RO	Reset to 0

7.5.118 SECONDARY UNCORRECTABLE ERROR SEVERITY REGISTER – OFFSET 134h

BIT	FUNCTION	TYPE	DESCRIPTION
0	Target Abort on Split Completion Severity	RWS	Reset to 0
1	Master Abort on Split Completion Severity	RWS	Reset to 0
2	Received Target Abort Severity	RWS	Reset to 0
3	Received Master Abort Severity	RWS	Reset to 0
4	Reserved	RO	Reset to 0
5	Unexpected Split Completion Error Severity	RWS	Reset to 0
6	Uncorrectable Split Completion Message Data Error Severity	RWS	Reset to 1
7	Uncorrectable Data Error Severity	RWS	Reset to 0
8	Uncorrectable Attribute Error Severity	RWS	Reset to 1
9	Uncorrectable Address Error Severity	RWS	Reset to 1
10	Delayed Transaction Discard Timer Expired Severity	RWS	Reset to 0
11	PERR_L Assertion Detected Severity	RWS	Reset to 0
12	SERR_L Assertion Detected Severity	RWS	Reset to 1
13	Internal Bridge Error Severity	RWS	Reset to 0
31:14	Reserved	RO	Reset to 0

7.5.119 SECONDARY ERROR CAPABILITY AND CONTROL REGISTER – OFFSET 138h

BIT	FUNCTION	TYPE	DESCRIPTION
4:0	Secondary First Error Pointer	ROW	Reset to 0
31:5	Reserved	RO	Reset to 0

7.5.120 SECONDARY HEADER LOG REGISTER – OFFSET 13Ch – 148h

BIT	FUNCTION	TYPE	DESCRIPTION
35:0	Transaction Attribute	ROS	Transaction attribute, CBE [3:0] and AD [31:0] during attribute phase Reset to 0
39:36	Transaction Command Lower	ROS	Transaction command lower, CBE [3:0] during first address phase Reset to 0
43:40	Transaction Command Upper	ROS	Transaction command upper, CBE [3:0] during second address phase of DAC transaction Reset to 0

BIT	FUNCTION	TYPE	DESCRIPTION
63:44	Reserved	ROS	Reset to 0
95:64	Transaction Address	ROS	Transaction address, AD [31:0] during first address phase Reset to 0
127:96	Transaction Address	ROS	Transaction address, AD [31:0] during second address phase of DAC transaction Reset to 0

7.5.121 RESERVED REGISTER – OFFSET 14Ch

7.5.122 VC CAPABILITY ID REGISTER – OFFSET 150h

BIT	FUNCTION	TYPE	DESCRIPTION
15:0	VC Capability ID	RO	Reset to 0002h

7.5.123 VC CAPABILITY VERSION REGISTER – OFFSET 150h

BIT	FUNCTION	TYPE	DESCRIPTION
19:16	VC Capability Version	RO	Reset to 1h

7.5.124 NEXT CAPABILITY OFFSET REGISTER – OFFSET 150h

BIT	FUNCTION	TYPE	DESCRIPTION
31:20	Next Capability Offset	RO	Next capability offset – the end of capabilities Reset to 0

7.5.125 PORT VC CAPABILITY REGISTER 1 – OFFSET 154h

BIT	FUNCTION	TYPE	DESCRIPTION
2:0	Extended VC Count	RO	Reset to 0
3	Reserved	RO	Reset to 0
6:4	Low Priority Extended VC Count	RO	Reset to 0
7	Reserved	RO	Reset to 0
9:8	Reference Clock	RO	Reset to 0
11:10	Port Arbitration Table Entry Size	RO	Reset to 0
31:12	Reserved	RO	Reset to 0

7.5.126 PORT VC CAPABILITY REGISTER 2 – OFFSET 158h

BIT	FUNCTION	TYPE	DESCRIPTION
7:0	VC Arbitration Capability	RO	Reset to 0
23:8	Reserved	RO	Reset to 0
31:24	VC Arbitration Table Offset	RO	Reset to 0

7.5.127 PORT VC CONTROL REGISTER – OFFSET 15Ch

BIT	FUNCTION	TYPE	DESCRIPTION
0	Load VC Arbitration Table	RO	Reset to 0
3:1	VC Arbitration Select	RO	Reset to 0
15:4	Reserved	RO	Reset to 0

7.5.128 PORT VC STATUS REGISTER – OFFSET 15Ch

BIT	FUNCTION	TYPE	DESCRIPTION
16	VC Arbitration Table Status	RO	Reset to 0
31:17	Reserved	RO	Reset to 0

7.5.129 VC0 RESOURCE CAPABILITY REGISTER – OFFSET 160h

BIT	FUNCTION	TYPE	DESCRIPTION
7:0	Port Arbitration Capability	RO	Reset to 0
13:8	Reserved	RO	Reset to 0
14	Advanced Packet Switching	RO	Reset to 0
15	Reject Snoop Transactions	RO	Reset to 0
22:16	Maximum Time Slots	RO	Reset to 0
23	Reserved	RO	Reset to 0
31:24	Port Arbitration Table Offset	RO	Reset to 0

7.5.130 VC0 RESOURCE CONTROL REGISTER – OFFSET 164h

BIT	FUNCTION	TYPE	DESCRIPTION
0	TC / VC Map	RO	For TC0 Reset to 1
7:1	TC / VC Map	RW	For TC7 to TC1 Reset to 7Fh
15:8	Reserved	RO	Reset to 0
16	Load Port Arbitration Table	RO	Reset to 0
19:17	Port Arbitration Select	RO	Reset to 0
23:20	Reserved	RO	Reset to 0
26:24	VC ID	RO	Reset to 0
30:27	Reserved	RO	Reset to 0
31	VC Enable	RO	Reset to 1

7.5.131 VC0 RESOURCE STATUS REGISTER – OFFSET 168h

BIT	FUNCTION	TYPE	DESCRIPTION
0	Port Arbitration Table 1	RO	Reset to 0
1	VC0 Negotiation Pending	RO	Reset to 0
31:2	Reserved	RO	Reset to 0

7.5.132 RESERVED REGISTERS – OFFSET 16Ch – 300h

7.5.133 EXTRA GPI/GPO DATA AND CONTROL REGISTER – OFFSET 304h

BIT	FUNCTION	TYPE	DESCRIPTION
3:0	Extra GPO	RWC	GPO [3:0], write 1 to clear Reset to 0
7:4	Extra GPO	RWS	GPO [3:0], write 1 to set Reset to 0
11:8	Extra GPO enable	RWC	GPO [3:0] enable, write 1 to clear Reset to 0
15:12	Extra GPO enable	RWS	GPO [3:0] enable, write 1 to set Reset to 0
19:16	Extra GPI	RO	Extra GPI [3:0] Data Register Reset to 0
31:20	Reserved	RO	Reset to 0

7.5.134 RESERVED REGISTERS – OFFSET 308h – 30Ch

7.5.135 REPLAY AND ACKNOWLEDGE LATENCY TIMERS – OFFSET 310h

BIT	FUNCTION	TYPE	DESCRIPTION
11:0	Replay Timer	RW	Replay Timer Reset to 20Bh
12	Replay Timer Enable	RW	Replay Timer Enable Reset to 0
15:13	Reserved	RO	Reset to 0
29:16	Acknowledge Latency Timer	RW	Acknowledge Latency Timer Reset to 127h
30	Acknowledge Latency Timer Enable	RO	Acknowledge Latency Timer Enable Reset to 0
31	Reserved	RO	Reset to 0

7.5.136 RESERVED REGISTERS – OFFSET 314h – FFCh

7.6 CONTROL AND STATUS REGISTERS FOR NON-TRANSPARENT BRIDGE MODE

Control and Status Registers (CSR's) can be accessed by Memory or I/O transactions from both primary and secondary ports. The CSR's are defined and to be used along with configuration registers (see previous section 7.5 for details) for non-transparent bridge operations.

Register Type	Descriptions
RO	Read Only
ROS	Read Only and Sticky
RW	Read/Write
RWC	Read/Write "1" to clear
RWS	Read/Write and Sticky
RWCS	Read/Write "1" to clear and Sticky

7.6.1 RESERVED REGISTERS – OFFSET 000h TO 004h

7.6.2 DOWNSTREAM MEMORY 2 TRANSLATED BASE REGISTER – OFFSET 008h

BIT	FUNCTION	TYPE	DESCRIPTION
11:0	Reserved	RO	Reset to 000h
31:12	Downstream Memory 2 Translated Base	RW	Define the translated base address for downstream memory transactions whose initiator addresses fall into Downstream Memory 2 address range. The number of bits that are used for translated base is determined by its setup register (offset 00Ch) Reset to 00000h

7.6.3 DOWNSTREAM MEMORY 2 SETUP REGISTER – OFFSET 00Ch

BIT	FUNCTION	TYPE	DESCRIPTION
0	Type Selector	RO	0: Memory space is requested Reset to 0
2:1	Address Type	RO (WS)	00: 32-bit address space 01: 64-bit address space Reset to 00
3	Prefetchable Control	RO (WS)	0: Non-prefetchable 1: Prefetchable Reset to 0
11:4	Reserved	RO	Reset to 00
30:12	Base Address Register Size	RO (WS)	0: Set the corresponding bit in the Base Address Register to read only 1: Set the corresponding bit in the Base Address Register to read/write in order to control the size of the address range Reset to 00000h
31	Base Address Register Enable	RO (WS)	0: Disable this Base Address Register 1: Enable this Base Address Register Reset to 0

7.6.4 DOWNSTREAM MEMORY 3 TRANSLATED BASE REGISTER – OFFSET 010h

BIT	FUNCTION	TYPE	DESCRIPTION
11:0	Reserved	RO	Reset to 000000

BIT	FUNCTION	TYPE	DESCRIPTION
31:12	Downstream Memory 3 Translated Base	RW	Define the translated base address for downstream memory transactions whose initiator addresses fall into Downstream Memory 3 address range. The number of bits that are used for translated base is determined by its setup register (offset 014h) Reset to 00000h

7.6.5 DOWNSTREAM MEMORY 3 SETUP REGISTER – OFFSET 014h

BIT	FUNCTION	TYPE	DESCRIPTION
0	Type Selector	RO	0: Memory space is requested Reset to 0
2:1	Address Type	RO (WS)	00: 32-bit address space 01: 64-bit address space Reset to 00
3	Prefetchable Control	RO (WS)	0: Non-prefetchable 1: Prefetchable Reset to 0
11:4	Reserved	RO	Reset to 00
30:12	Base Address Register Size	RO (WS)	0: Set the corresponding bit in the Base Address Register to read only 1: Set the corresponding bit in the Base Address Register to read/write in order to control the size of the address range Reset to 00000h
31	Base Address Register Enable	RO (WS)	0: Disable this Base Address Register 1: Enable this Base Address Register Reset to 0

7.6.6 DOWNSTREAM MEMORY 3 UPPER 32-BIT SETUP REGISTER – OFFSET 018h

BIT	FUNCTION	TYPE	DESCRIPTION
30:0	Base Address Register Size	RW	0: Set the corresponding bit in the Upper 32-bit Base Address Register to read only 1: Set the corresponding bit in the Upper 32-bit Base Address Register to read/write in order to control the size of the address range Reset to 00000000h
31	Base Address Register Enable	RW)	0: Disable 64-bit Base Address Register 1: Enable 64-bit Base Address Register Reset to 0

7.6.7 RESERVED REGISTERS – OFFSET 01Ch TO 030h

7.6.8 UPSTREAM MEMORY 3 SETUP REGISTER – OFFSET 34h

BIT	FUNCTION	TYPE	DESCRIPTION
0	Type Selector	RO	0: Memory space is requested Reset to 0
2:1	Address Type	RO	00: 32-bit address space 01: 64-bit address space Reset to 01

BIT	FUNCTION	TYPE	DESCRIPTION
3	Prefetchable Control	RW	0: Non-prefetchable 1: Prefetchable Reset to 0
11:4	Reserved	RO	Reset to 00
31:12	Base Address Register Size	RW	0: Set the corresponding bit in the Base Address Register to read only 1: Set the corresponding bit in the Base Address Register to read/write in order to control the size of the address range Reset to 00000h

7.6.9 UPSTREAM MEMORY 3 UPPER 32-BIT SETUP REGISTER – OFFSET 038h

BIT	FUNCTION	TYPE	DESCRIPTION
30:0	Base Address Register Size	RW	0: Set the corresponding bit in the Upper 32-bit Base Address Register to read only 1: Set the corresponding bit in the Upper 32-bit Base Address Register to read/write in order to control the size of the address range Reset to 00000000h
31	Base Address Register Enable	RW	0: Disable 64-bit Base Address Register 1: Enable 64-bit Base Address Register Reset to 0

7.6.10 RESERVED REGISTERS – OFFSET 03Ch TO 04Ch

7.6.11 LOOKUP TABLE OFFSET – OFFSET 050h

BIT	FUNCTION	TYPE	DESCRIPTION
7:0	Lookup Table Offset	RW	This register contains the byte offset of the Lookup Table Entry to be accessed for upstream memory 2. The access is initiated when the lookup Table Data Register is accessed. This register should be written first before any Lookup Table Data access. Reset to 00h
31:8	Reserved	RO	Reset to 0

7.6.12 LOOKUP TABLE DATA – OFFSET 054h

BIT	FUNCTION	TYPE	DESCRIPTION
0	Valid	RW	0: Invalid lookup 1: Valid lookup Reset to 0
2:1	Reserved	RO	Reset to 00
3	Prefetchable	RW	0: Memory address is non-prefetchable 1: Memory address is Reset to 0
7:4	Reserved	RO	Reset to 0h

BIT	FUNCTION	TYPE	DESCRIPTION
24:8	Translated base or Reserved	RW/RO	Data written or read from the Lookup Table at the offset specified in the Lookup Table Offset Register. When writing to this register, the data value is written to the specified Lookup Table entry. When reading from this register, the data reflects the data value from the specified Lookup Table entry. The bit [24:8] is Translated Base Register bit when the lookup table size is set to 256B range. The bit [24:8] is reserved when the lookup table size is set to 32MB range (see PCI configuration offset 68h for non-transparent mode). Reset to 0
31:25	Translated Base	RW	Data written or read from the Lookup Table at the offset specified in the Lookup Table Offset Register. When writing to this register, the data value is written to a specific Lookup Table entry (CSR offset 100h – 1FFh). When reading from this register, the data reflects the data value from the specific Lookup Table entry. Reset to 0

7.6.13 UPSTREAM PAGE BOUNDARY IRQ 0 REQUEST REGISTER – OFFSET 058h

BIT	FUNCTION	TYPE	DESCRIPTION
31:0	Upstream Page Boundary IRQ 0	RWC	Each interrupt request bit is correspondent to a page entry in the lower half of the Upstream Memory 2 range. Bit [0] is for the first page, and bit [31] is for the 32 nd page. PI7C9X110 sets the appropriate bit when it successfully transfers data to or from the imitator that addresses the last Double Word in a page. PI7C9X110 initiates an interrupt request on secondary interface when the interrupt request bit is set and the corresponding Upstream Page Boundary IRQ 0 Mask bit is reset. When forward bridge, PI7C9X110 asserts INTA_L or generates MSI on secondary bus (PCI interface). When reverse bridge, PI7C9X110 sends INTA_L assertion message or generates MSI on secondary interface (PCI Express). When writing a “1” to this register, it clears the corresponding interrupt request bit. Reset to 0

7.6.14 UPSTREAM PAGE BOUNDARY IRQ 1 REQUEST REGISTER – OFFSET 05Ch

BIT	FUNCTION	TYPE	DESCRIPTION
31:0	Upstream Page Boundary IRQ 1	RWC	Each interrupt request bit is correspondent to a page entry in the lower half of the Upstream Memory 2 range. Bit [0] is for the 33 rd page, and bit [31] is for the 64 th page. PI7C9X110 sets the appropriate bit when it successfully transfers data to or from the initiator that addresses the last Double Word in a page. PI7C9X110 initiates an interrupt request on secondary interface when the interrupt request bit is set and the corresponding Upstream Page Boundary IRQ 1 Mask bit is reset. When forward bridge, PI7C9X110 asserts INTA_L or generates MSI on secondary bus (PCI interface). When reverse bridge, PI7C9X110 sends INTA_L assertion message or generates MSI on secondary interface (PCI Express). When writing a “1” to this register, it clears the corresponding interrupt request bit. Reset to 0

7.6.15 UPSTREAM PAGE BOUNDARY IRQ 0 MASK REGISTER – OFFSET 060h

BIT	FUNCTION	TYPE	DESCRIPTION
31:0	Upstream Page Boundary IRQ 0 Mask	RWC	0: PI7C9X110 can initiate an interrupt request when the correspondent request bit is set 1: PI7C9X110 cannot initiate any interrupt request even though the correspondent request bit is set Reset to FFFFFFFh

7.6.16 UPSTREAM PAGE BOUNDARY IRQ 1 MASK REGISTER – OFFSET 064h

BIT	FUNCTION	TYPE	DESCRIPTION
31:0	Upstream Page Boundary IRQ 1 Mask	RWC	0: PI7C9X110 can initiate an interrupt request when the correspondent request bit is set 1: PI7C9X110 cannot initiate any interrupt request even though the correspondent request bit is set Reset to FFFFFFFh

7.6.17 RESERVED REGISTER – OFFSET 068C

7.6.18 PRIMARY CLEAR IRQ REGISTER – OFFSET 070h

BIT	FUNCTION	TYPE	DESCRIPTION
15:0	Primary Clear IRQ	RWC	When writing “1” to this register bit, it clears the correspondent interrupt request bit. When reading this register, it returns the interrupt request bit status: 0: It is not the bit that causes the interrupt request on primary interface 1: It is the bit that causes the interrupt request on primary interface Reset to 0000h

7.6.19 SECONDARY CLEAR IRQ REGISTER – OFFSET 070h

BIT	FUNCTION	TYPE	DESCRIPTION
31:16	Secondary Clear IRQ	RWC	When writing “1” to this register bit, it clears the correspondent interrupt request bit. When reading this register, it returns the interrupt request bit status: 0: It is not the bit that causes the interrupt request on secondary interface 1: It is the bit that causes the interrupt request on secondary interface Reset to 0000h

7.6.20 PRIMARY SET IRQ REGISTER – OFFSET 074h

BIT	FUNCTION	TYPE	DESCRIPTION
15:0	Primary Set IRQ	RWS	<p>When writing “1” to this register bit, it set the correspondent interrupt request bit.</p> <p>When reading this register, it returns the interrupt request bit status:</p> <p>0: It is not the bit that causes the interrupt request on primary interface 1: It is the bit that causes the interrupt request on primary interface</p> <p>Reset to 0000h</p>

7.6.21 SECONDARY SET IRQ REGISTER – OFFSET 074h

BIT	FUNCTION	TYPE	DESCRIPTION
31:16	Secondary Set IRQ	RWS	<p>When writing “1” to this register bit, it set the correspondent interrupt request bit.</p> <p>When reading this register, it returns the interrupt request bit status:</p> <p>0: It is not the bit that causes the interrupt request on secondary interface 1: It is the bit that causes the interrupt request on secondary interface</p> <p>Reset to 0000h</p>

7.6.22 PRIMARY CLEAR IRQ MASK REGISTER – OFFSET 078h

BIT	FUNCTION	TYPE	DESCRIPTION
15:0	Primary Clear IRQ Mask	RWS	<p>When writing “1” to this register bit, it clears the correspondent interrupt request mask bit.</p> <p>When reading this register, it returns the primary Clear IRQ Mask bit status:</p> <p>0: It allows to clear an interrupt request on primary interface 1: It does not allow to clear any interrupt request on primary interface</p> <p>Reset to FFFFh</p>

7.6.23 SECONDARY CLEAR IRQ MASK REGISTER – OFFSET 078h

BIT	FUNCTION	TYPE	DESCRIPTION
31:16	Secondary Clear IRQ Mask	RWS	<p>When writing “1” to this register bit, it clears the correspondent interrupt request mask bit.</p> <p>When reading this register, it returns the Secondary Clear IRQ Mask bit status:</p> <p>0: It allows to clear an interrupt request on secondary interface 1: It does not allow to clear any interrupt request on secondary interface</p> <p>Reset to FFFFh</p>

7.6.24 PRIMARY SET IRQ MASK REGISTER – OFFSET 07Ch

BIT	FUNCTION	TYPE	DESCRIPTION
15:0	Primary Set IRQ Mask	RWS	<p>When writing “1” to this register bit, it set the correspondent interrupt request mask bit.</p> <p>When reading this register, it returns the Primary Set IRQ Mask bit status:</p> <p>0: It allows to set an interrupt request on primary interface 1: It does not allow to set any interrupt request on primary interface</p> <p>Reset to FFFFh</p>

7.6.25 SECONDARY SET IRQ MASK REGISTER – OFFSET 07Ch

BIT	FUNCTION	TYPE	DESCRIPTION
31:16	Secondary Set IRQ Mask	RWC	<p>When writing “1” to this register bit, it set the correspondent interrupt request mask bit.</p> <p>When reading this register, it returns the Secondary Set IRQ Mask bit status:</p> <p>0: It allows to set an interrupt request on secondary interface 1: It does not allow to set any interrupt request on secondary interface</p> <p>Reset to FFFFh</p>

7.6.26 RESERVED REGISTERS – OFFSET 080h TO 09Ch

7.6.27 SCRATCHPAD 0 REGISTER – OFFSET 0A0h

BIT	FUNCTION	TYPE	DESCRIPTION
31:0	Scratchpad 0	RW	<p>The scratchpad is a 32-bit internal register that can be accessed from both primary and secondary interfaces. The external devices can use the scratchpad as a temporary storage. Primary and secondary bus devices can communicate through the scratchpad. However, writing and reading the scratchpad does not generate any interrupt request.</p> <p>Reset to 00000000h</p>

7.6.28 SCRATCHPAD 1 REGISTER – OFFSET 0A4h

BIT	FUNCTION	TYPE	DESCRIPTION
31:0	Scratchpad 1	RW	<p>The scratchpad is a 32-bit internal register that can be accessed from both primary and secondary interfaces. The external devices can use the scratchpad as a temporary storage. Primary and secondary bus devices can communicate through the scratchpad. However, writing and reading the scratchpad does not generate any interrupt request.</p> <p>Reset to 00000000h</p>

7.6.29 SCRATCHPAD 2 REGISTER – OFFSET 0A8h

BIT	FUNCTION	TYPE	DESCRIPTION
31:0	Scratchpad 2	RW	The scratchpad is a 32-bit internal register that can be accessed from both primary and secondary interfaces. The external devices can use the scratchpad as a temporary storage. Primary and secondary bus devices can communicate through the scratchpad. However, writing and reading the scratchpad does not generate any interrupt request. Reset to 00000000h

7.6.30 SCRATCHPAD 3 REGISTER – OFFSET 0ACh

BIT	FUNCTION	TYPE	DESCRIPTION
31:0	Scratchpad 3	RW	The scratchpad is a 32-bit internal register that can be accessed from both primary and secondary interfaces. The external devices can use the scratchpad as a temporary storage. Primary and secondary bus devices can communicate through the scratchpad. However, writing and reading the scratchpad does not generate any interrupt request. Reset to 00000000h

7.6.31 SCRATCHPAD 4 REGISTER – OFFSET 0B0h

BIT	FUNCTION	TYPE	DESCRIPTION
31:0	Scratchpad 4	RW	The scratchpad is a 32-bit internal register that can be accessed from both primary and secondary interfaces. The external devices can use the scratchpad as a temporary storage. Primary and secondary bus devices can communicate through the scratchpad. However, writing and reading the scratchpad does not generate any interrupt request. Reset to 00000000h

7.6.32 SCRATCHPAD 5 REGISTER – OFFSET 0B4h

BIT	FUNCTION	TYPE	DESCRIPTION
31:0	Scratchpad 5	RW	The scratchpad is a 32-bit internal register that can be accessed from both primary and secondary interfaces. The external devices can use the scratchpad as a temporary storage. Primary and secondary bus devices can communicate through the scratchpad. However, writing and reading the scratchpad does not generate any interrupt request. Reset to 00000000h

7.6.33 SCRATCHPAD 6 REGISTER – OFFSET 0B8h

BIT	FUNCTION	TYPE	DESCRIPTION
31:0	Scratchpad 6	RW	The scratchpad is a 32-bit internal register that can be accessed from both primary and secondary interfaces. The external devices can use the scratchpad as a temporary storage. Primary and secondary bus devices can communicate through the scratchpad. However, writing and reading the scratchpad does not generate any interrupt request. Reset to 00000000h

7.6.34 SCRATCHPAD 7 REGISTER – OFFSET 0BCh

BIT	FUNCTION	TYPE	DESCRIPTION
31:0	Scratchpad 7	RW	The scratchpad is a 32-bit internal register that can be accessed from both primary and secondary interfaces. The external devices can use the scratchpad as a temporary storage. Primary and secondary bus devices can communicate through the scratchpad. However, writing and reading the scratchpad does not generate any interrupt request. Reset to 00000000h

7.6.35 RESERVED REGISTERS – OFFSET 0C0h TO 0FCh

7.6.36 LOOKUP TABLE REGISTERS – OFFSET 100h TO 1FCh

BIT	FUNCTION	TYPE	DESCRIPTION																																																																
2047:0	Lookup Table	RW	The lookup table has 64 entries. Each entry has 32-bit mapped to each page of the Upstream Memory 2 base address range <table border="1"> <tr><td>64th page: bit [2047:2016]</td><td>63rd page: bit [2015:1984]</td></tr> <tr><td>62nd page: bit [1983:1952]</td><td>61st page: bit [1951:1920]</td></tr> <tr><td>60th page: bit [1919:1888]</td><td>59th page: bit [1887:1856]</td></tr> <tr><td>58th page: bit [1855:1824]</td><td>57th page: bit [1823:1792]</td></tr> <tr><td>56th page: bit [1791:1760]</td><td>55th page: bit [1759:1728]</td></tr> <tr><td>54th page: bit [1727:1696]</td><td>53rd page: bit [1695:1664]</td></tr> <tr><td>52nd page: bit [1663:1632]</td><td>51st page: bit [1631:1600]</td></tr> <tr><td>50th page: bit [1599:1568]</td><td>49th page: bit [1567:1536]</td></tr> <tr><td>48th page: bit [1535:1504]</td><td>47th page: bit [1503:1472]</td></tr> <tr><td>46th page: bit [1471:1440]</td><td>45th page: bit [1439:1408]</td></tr> <tr><td>44th page: bit [1407:1376]</td><td>43rd page: bit [1375:1344]</td></tr> <tr><td>42nd page: bit [1343:1312]</td><td>41st page: bit [1311:1280]</td></tr> <tr><td>40th page: bit [1279:1248]</td><td>39th page: bit [1247:1216]</td></tr> <tr><td>38th page: bit [1215:1184]</td><td>37th page: bit [1183:1152]</td></tr> <tr><td>36th page: bit [1151:1120]</td><td>35th page: bit [1119:1088]</td></tr> <tr><td>34th page: bit [1087:1056]</td><td>33rd page: bit [1055:1024]</td></tr> <tr><td>32nd page: bit [1023:992]</td><td>31st page: bit [991:960]</td></tr> <tr><td>30th page: bit [959:928]</td><td>29th page: bit [927:896]</td></tr> <tr><td>28th page: bit [895:864]</td><td>27th page: bit [863:832]</td></tr> <tr><td>26th page: bit [831:800]</td><td>25th page: bit [799:768]</td></tr> <tr><td>24th page: bit [767:736]</td><td>23rd page: bit [735:704]</td></tr> <tr><td>22nd page: bit [703:672]</td><td>21st page: bit [671:640]</td></tr> <tr><td>20th page: bit [639:608]</td><td>19th page: bit [607:576]</td></tr> <tr><td>18th page: bit [575:544]</td><td>17th page: bit [543:512]</td></tr> <tr><td>16th page: bit [511:480]</td><td>15th page: bit [479:448]</td></tr> <tr><td>14th page: bit [447:416]</td><td>13th page: bit [415:383]</td></tr> <tr><td>12th page: bit [382:352]</td><td>11th page: bit [351:320]</td></tr> <tr><td>10th page: bit [319:288]</td><td>9th page: bit [287:256]</td></tr> <tr><td>8th page: bit [255:224]</td><td>7th page: bit [223:192]</td></tr> <tr><td>6th page: bit [191:160]</td><td>5th page: bit [159:128]</td></tr> <tr><td>4th page: bit [127:96]</td><td>3rd page: bit [95:64]</td></tr> <tr><td>2nd page: bit [63:32]</td><td>1st page: bit [31:0]</td></tr> </table> Reset to unknown	64 th page: bit [2047:2016]	63 rd page: bit [2015:1984]	62 nd page: bit [1983:1952]	61 st page: bit [1951:1920]	60 th page: bit [1919:1888]	59 th page: bit [1887:1856]	58 th page: bit [1855:1824]	57 th page: bit [1823:1792]	56 th page: bit [1791:1760]	55 th page: bit [1759:1728]	54 th page: bit [1727:1696]	53 rd page: bit [1695:1664]	52 nd page: bit [1663:1632]	51 st page: bit [1631:1600]	50 th page: bit [1599:1568]	49 th page: bit [1567:1536]	48 th page: bit [1535:1504]	47 th page: bit [1503:1472]	46 th page: bit [1471:1440]	45 th page: bit [1439:1408]	44 th page: bit [1407:1376]	43 rd page: bit [1375:1344]	42 nd page: bit [1343:1312]	41 st page: bit [1311:1280]	40 th page: bit [1279:1248]	39 th page: bit [1247:1216]	38 th page: bit [1215:1184]	37 th page: bit [1183:1152]	36 th page: bit [1151:1120]	35 th page: bit [1119:1088]	34 th page: bit [1087:1056]	33 rd page: bit [1055:1024]	32 nd page: bit [1023:992]	31 st page: bit [991:960]	30 th page: bit [959:928]	29 th page: bit [927:896]	28 th page: bit [895:864]	27 th page: bit [863:832]	26 th page: bit [831:800]	25 th page: bit [799:768]	24 th page: bit [767:736]	23 rd page: bit [735:704]	22 nd page: bit [703:672]	21 st page: bit [671:640]	20 th page: bit [639:608]	19 th page: bit [607:576]	18 th page: bit [575:544]	17 th page: bit [543:512]	16 th page: bit [511:480]	15 th page: bit [479:448]	14 th page: bit [447:416]	13 th page: bit [415:383]	12 th page: bit [382:352]	11 th page: bit [351:320]	10 th page: bit [319:288]	9 th page: bit [287:256]	8 th page: bit [255:224]	7 th page: bit [223:192]	6 th page: bit [191:160]	5 th page: bit [159:128]	4 th page: bit [127:96]	3 rd page: bit [95:64]	2 nd page: bit [63:32]	1 st page: bit [31:0]
64 th page: bit [2047:2016]	63 rd page: bit [2015:1984]																																																																		
62 nd page: bit [1983:1952]	61 st page: bit [1951:1920]																																																																		
60 th page: bit [1919:1888]	59 th page: bit [1887:1856]																																																																		
58 th page: bit [1855:1824]	57 th page: bit [1823:1792]																																																																		
56 th page: bit [1791:1760]	55 th page: bit [1759:1728]																																																																		
54 th page: bit [1727:1696]	53 rd page: bit [1695:1664]																																																																		
52 nd page: bit [1663:1632]	51 st page: bit [1631:1600]																																																																		
50 th page: bit [1599:1568]	49 th page: bit [1567:1536]																																																																		
48 th page: bit [1535:1504]	47 th page: bit [1503:1472]																																																																		
46 th page: bit [1471:1440]	45 th page: bit [1439:1408]																																																																		
44 th page: bit [1407:1376]	43 rd page: bit [1375:1344]																																																																		
42 nd page: bit [1343:1312]	41 st page: bit [1311:1280]																																																																		
40 th page: bit [1279:1248]	39 th page: bit [1247:1216]																																																																		
38 th page: bit [1215:1184]	37 th page: bit [1183:1152]																																																																		
36 th page: bit [1151:1120]	35 th page: bit [1119:1088]																																																																		
34 th page: bit [1087:1056]	33 rd page: bit [1055:1024]																																																																		
32 nd page: bit [1023:992]	31 st page: bit [991:960]																																																																		
30 th page: bit [959:928]	29 th page: bit [927:896]																																																																		
28 th page: bit [895:864]	27 th page: bit [863:832]																																																																		
26 th page: bit [831:800]	25 th page: bit [799:768]																																																																		
24 th page: bit [767:736]	23 rd page: bit [735:704]																																																																		
22 nd page: bit [703:672]	21 st page: bit [671:640]																																																																		
20 th page: bit [639:608]	19 th page: bit [607:576]																																																																		
18 th page: bit [575:544]	17 th page: bit [543:512]																																																																		
16 th page: bit [511:480]	15 th page: bit [479:448]																																																																		
14 th page: bit [447:416]	13 th page: bit [415:383]																																																																		
12 th page: bit [382:352]	11 th page: bit [351:320]																																																																		
10 th page: bit [319:288]	9 th page: bit [287:256]																																																																		
8 th page: bit [255:224]	7 th page: bit [223:192]																																																																		
6 th page: bit [191:160]	5 th page: bit [159:128]																																																																		
4 th page: bit [127:96]	3 rd page: bit [95:64]																																																																		
2 nd page: bit [63:32]	1 st page: bit [31:0]																																																																		

7.6.37 RESERVED REGISTERS – OFFSET 200h TO FFCh

8 GPIO PINS AND SM BUS ADDRESS

GPIO [3:1] of PI7C9X110 are defined for hot-plug usage if MSK_IN=1 during Reset. Please see configuration register definition (offset 78h – 7Bh).

In Forward bridge:

- GPIO[0] : PCI slot Card Presence Detection Input
- GPIO[1] : Attention Button Pressed Input
- GPIO[2] : Power Indication Output
- GPIO[3] : Attention Indication Output

In Reverse bridge:

- GPIO[0] : PCIe slot Card Presence Detection Input
- GPIO[1] : MRL Sensor Input
- GPIO[2] : Reserved
- GPIO[3] : Reserved

GPIO [3:0] are also defined the address bits of SMBUS device ID if SM Bus is selected (TM1=1). The address-strapping table of SMBUS with GPIO [3:0] pins is defined in the following table:

Table 8-1 SM Bus Device ID Strapping

SM Bus Address Bit	SM Bus device ID
Address bit [7]	= 1
Address bit [6]	= 1
Address bit [5]	= 0
Address bit [4]	= GPIO [3]
Address bit [3]	= GPIO [2]
Address bit [2]	= GPIO [1]
Address bit [1]	= GPIO [0]

GPIO [3:0] pins can be further defined to serve other functions in the next generation Device.

Four GPI [3:0] and four GPO [3:0] have been added to PI7C9X110 when external arbiter is selected (CFN_L=1). If external arbiter is selected, REQ_L [5:2] and GNT [5:2] will become the GPI [3:0] and GPO [3:0] respectively.

If Hot Plug Control is implemented thru PI7C9X110 device, the pin function of GPIO [3:0] configured in Forward or Reverse Mode are defined as follow:

In Forward Mode:

- GPIO[0] : PCI slot Card Presence Detection Input
- GPIO[1] : Attention Button Pressed Input
- GPIO[2] : Power Indication Output
- GPIO[3] : Attention Indication Output

In Reverse Mode:

- GPIO[0] : PCIe slot Card Presence Detection Input
- GPIO[1] : MRL Sensor Input
- GPIO[2] : Reserved
- GPIO[3] : Reserved

9 CLOCK SCHEME

PCI Express interface:

PI7C9X110 requires 100MHz differential clock inputs through REFCLKP and REFCLKN Pins.

PCI interface:

PI7C9X110 requires PCI clock (up to 66MHz and at least 10MHz) to be connected to the CLKIN. PI7C9X110 uses the CLKIN and generates nine clock outputs, CLKOUT [8:0]. Also, PI7C9X110 requires one of the CLKOUT [8:0] (preferably CLKOUT [8]) to be connected to FBCLKIN for the PCI interface logic of PI7C9X110. The actual number of masters supported will vary depending on the loading of the PCI bus. Typically, PI7C9X110 can support up to four 66MHz PCI slots or eight 33MHz PCI slots.

The PI7C9X110 PCI Clock Outputs, CLKOUT [8:0], can be enabled or disabled through the configuration register.

10 INTERRUPTS

PI7C9X110 supports interrupt message packets on PCIe side. PI7C9X110 supports PCI interrupt (INTA, B, C, D) pins or MSI (Message Signaled Interrupts) on PCI side. PCI interrupts and MSI are mutually exclusive. In order words, if MSI is enabled, PCI interrupts will be disabled. PI7C9X110 support 64-bit addressing MSI.

In reverse bridge mode, PI7C9X110 maps the interrupt message packets to PCI interrupt pins or MSI if MSI is enable (see configuration register bit [16] of Offset F0h).

In forward bridge mode, PI7C9X110 maps the PCI interrupts pins or MSI if enable on PCI side to interrupt message packets on PCIe side.

There are eight interrupt message packets. They are Assert_INTA, Assert_INTB, Assert_INTC, Assert_INTD, Deassert_INTA, Deassert_INTB, Deassert_INTC, and Deassert_INTD. These eight interrupt messages are mapped to the four PCI interrupts (INTA, INTB, INTC, and INTD). See Table 10-1 for interrupt mapping information in reverse bridge mode. PI7C9X110 tracks the PCI interrupt (INTA, INTB, INTC, and INTD) pins and maps them to the eight interrupt messages. See Table 10-2 for interrupt mapping information in forward bridge mode.

Table 10-1 PCIe interrupt message to PCI interrupt mapping in reverse bridge mode

PCIe Interrupt messages (from sources of interrupt)	PCI Interrupts (to host controller)
INTA message	INTA
INTB message	INTB
INTC message	INTC
INTD message	INTD

Table 10-2 PCI interrupt to PCIe interrupt message mapping in forward bridge mode

PCI Interrupts (from sources of interrupts)	PCIe Interrupt message packets (to host controller)
INTA	INTA message
INTB	INTB message
INTC	INTC message
INTD	INTD message

11 EEPROM (I2C) INTERFACE AND SYSTEM MANAGEMENT BUS

11.1 EEPROM (I2C) INTERFACE

PI7C9X110 supports EEPROM interface through I2C bus. In EEPROM interface, pin A2 is the EEPROM clock (SCL) and pin A1 is the EEPROM data (SDL). When TM2 is strapped to low, TM1 selects EEPROM interface or System Management Bus. To select EEPROM (I2C) interface, TM1 needs to be set to low. When EEPROM interface is selected, SCL is an output. SCL is the I2C bus clock to the I2C device. In addition, SDL is a bi-directional signal for sending and receiving data.

11.2 SYSTEM MANAGEMENT BUS

PI7C9X110 supports SM bus protocol if TM1=1 when TM2 is strapped to low. In addition, SMBCLK (pin A2) and SMBDAT (pin A1) are utilized as the clock and data pins respectively for the SM bus.

When SM bus interface is selected, SMBCLK pin is an input for the clock of SM bus and SMBDAT pin is an open drain buffer that requires external pull-up resistor for proper operation.

12 HOT PLUG OPERATION

PI7C9X110 is not equipped with standard hot-plug controller (SHPC) integrated. However, PI7C9X110 supports hot-plug signaling messages and registers to simplify the implementation of hot-plug system.

Using PI7C9X110 on motherboard:

- PI7C9X110 supports hot-plug on PCI bus if forward bridging is selected (REVRSB=0).
- PI7C9X110 supports hot-plug function on PCI Express bus when reverse bridge mode is selected (REVRSB=1).

Using PI7C9X110 on add-in card:

- PI7C9X110 supports hot-plug on PCI Express bus in forward bridge mode. Hot-plug messages will be generated by PI7C9X110 based on the add-in card conditions.
- PI7C9X110 supports hot-plug function on PCI bus when reverse bridge mode is selected. PI7C9X110 will tri-state the PCI bus when RESET is asserted. Also, PI7C9X110 will de-assert INTA_L if RESET is asserted. The state machine of PI7C9X110 PCI bus interface will remain idle if the RESET is asserted. After RESET is de-asserted, PI7C9X110 will remain in idle state until an address phase containing a valid address for PI7C9X110 or its downstream devices.
- PI7C9X110 expects the REFCLK signal will be provided to its upstream PCI Express Port prior to the de-assertion of RESET. The Downstream PCI Port of PI7C9X110 supports a range of frequency up to 66MHz.
- PI7C9X110 also supports subsystem vendor and subsystem ID. PI7C9X110 will ignore target response while the bus is idle.

PRSNT1# and PRSNT2# are not implemented on both PI7C9X110. The use of these two signals is mandatory on an add-in card in order to support hot-plug.

13 RESET SCHEME

PI7C9X110 requires the fundamental reset (PERST_L) input for internal logic when it is set as forward bridge mode. PI7C9X110 requires the PCI reset (RESET_L) input when it is set as reverse bridge mode. Also, PI7C9X110 has a power-on-reset (POR) circuit to detect VDDCAUX power supply for auxiliary logic control.

- Cold Reset:

A cold reset is a fundamental or power-on reset that occurs right after the power is applied to PI7C9X110 (during initial power up). See section 7.1.1 of PCI Express to PCI Bridge Specification, Revision 1.0 for details.

- Warm Reset:

A warm reset is a reset that triggered by the hardware without removing and re-applying the power sources to PI7C9X110.

- Hot Reset:

A hot reset is a reset that used an in-band mechanism for propagating reset across a PCIe link to PI7C9X110. PI7C9X110 will enter to training control reset when it receives two consecutive TS1 or TS2 order-sets with reset bit set.

- DL_DOWN Reset:

If the PCIe link goes down, the Transaction and Data Link Layer will enter DL_DOWN status. PI7C9X110 discards all transactions and returns all logic and registers to initial state except the sticky registers.

Upon receiving reset (cold, warm, hot, or DL_DOWN) on PCIe interface, PI7C9X110 will generate PCI reset (RESET_L) to the downstream devices on the PCI bus in forward bridge mode. The PCI reset de-assertion follows the de-assertion of the reset received from PCIe interface. The reset bit of Bridge Control Register may be set depending on the application. PI7C9X110 will tolerant to receive and process SKIP order-sets at an average interval between 1180 to 1538 Symbol Times. PI7C9X110 does not keep PCI reset active when VD33 power is off even though VAUX (3.3v) is supported. It is recommended to add a weak pull-down resistor on its application board to ensure PCI reset is low when VD33 power is off (see section 7.3.2 of PCI Bus Power management Specification Revision 1.1).

In reverse bridge mode, PI7C9X110 generates fundamental reset (PERST_L) and then 1024 TS1 order-sets with reset bit set when PCI reset (RESET_L) is asserted to PI7C9X110. PI7C9X110 has scheduling skip order-set for insertion at an interval between 1180 and 1538 Symbol Times.

PI7C9X110 transmits one Electrical Idle order-set and enters to Electrical Idle.

14 IEEE 1149.1 COMPATIBLE JTAG CONTROLLER

An IEEE 1149.1 compatible Test Access Port (TAP) controller and associated TAP pins are provided to support boundary scan in PI7C9X110 for board-level continuity test and diagnostics. The TAP pins assigned are TCK, TDI, TDO, TMS and TRST_L. All digital input, output, input/output pins are tested except TAP pins.

The IEEE 1149.1 Test Logic consists of a TAP controller, an instruction register, and a group of test data registers including Bypass and Boundary Scan registers. The TAP controller is a synchronous 16-state machine driven by the Test Clock (TCK) and the Test Mode Select (TMS) pins. An independent power on reset circuit is provided to ensure the machine is in TEST_LOGIC_RESET state at power-up. The JTAG signal lines are not active when the PCI resource is operating PCI bus cycles.

14.1 INSTRUCTION REGISTER

PI7C9X110 implements a 5-bit Instruction register to control the operation of the JTAG logic. The defined instruction codes are shown in Table 14-1. Those bit combinations that are not listed are equivalent to the BYPASS (1111) instruction:

Table 14-1 Instruction register codes

Instruction	Operation Code (binary)	Register Selected	Operation
EXTEST	00000	Boundary Scan	Drives / receives off-chip test data
SAMPLE	00001	Boundary Scan	Samples inputs / pre-loads outputs
HIGHZ	00101	Bypass	Tri-states output and I/O pins except TDO pin
CLAMP	00100	Bypass	Drives pins from boundary-scan register and selects Bypass register for shifts
IDCODE	01100	Device ID	Accesses the Device ID register, to read manufacturer ID, part number, and version number
BYPASS	11111	Bypass	Selected Bypass Register
INT_SCAN	00010	Internal Scan	Scan test
MEM_BIST	01010	Memory BIST	Memory BIST test

14.2 BYPASS REGISTER

The required bypass register (one-bit shift register) provides the shortest path between TDI and TDO when a bypass instruction is in effect. This allows rapid movement of test data to and from other components on the board. This path can be selected when no test operation is being performed on the PI7C9X110.

14.3 DEVICE ID REGISTER

This register identifies Pericom as the manufacturer of the device and details the part number and revision number for the device.

Table 14-2 JTAG device ID register

Bit	Type	Value	Description
31:28	RO	01h	Version number
27:12	RO	E110h	Last 4 digits (hex) of the die part number
11:1	RO	23Fh	Pericom identifier assigned by JEDEC
0	RO	1b	Fixed bit equal to 1'b1

14.4 BOUNDARY SCAN REGISTER

The boundary scan register has a set of serial shift-register cells. A chain of boundary scan cells is formed by connected the internal signal of the PI7C9X110 package pins. The VDD, VSS, and JTAG pins are not in the boundary scan chain. The input to the shift register is TDI and the output from the shift register is TDO. There are 4 different types of boundary scan cells, based on the function of each signal pin.

The boundary scan register cells are dedicated logic and do not have any system function. Data may be loaded into the boundary scan register master cells from the device input pins and output pin-drivers in parallel by the mandatory SAMPLE and EXTEST instructions. Parallel loading takes place on the rising edge of TCK.

14.5 JTAG BOUNDARY SCAN REGISTER ORDER

Table 14-3 JTAG boundary scan register definition

Boundary Scan Register Number	Pin Name	Ball Location	Type	Tri-state Control Cell
0	AD [0]	K14	BIDIR	1
1	-	-	CONTROL	-
2	AD [1]	J11	BIDIR	3
3	-	-	CONTROL	-
4	AD [2]	J13	BIDIR	5
5	-	-	CONTROL	-
6	AD [3]	J14	BIDIR	7
7	-	-	CONTROL	-
8	AD [4]	H12	BIDIR	9
9	-	-	CONTROL	-
10	AD [5]	H13	BIDIR	11
11	-	-	CONTROL	-
12	AD [6]	G11	BIDIR	13
13	-	-	CONTROL	-
14	AD [7]	G12	BIDIR	15
15	-	-	CONTROL	-
16	CBE [0]	G14	BIDIR	17
17	-	-	CONTROL	-
18	AD [8]	F11	BIDIR	19
19	-	-	CONTROL	-
20	AD [9]	F13	BIDIR	21
21	-	-	CONTROL	-
22	AD [10]	F14	BIDIR	23
23	-	-	CONTROL	-
24	AD [11]	E13	BIDIR	25
25	-	-	CONTROL	-
26	AD [12]	D11	BIDIR	27
27	-	-	CONTROL	-
28	AD [13]	D12	BIDIR	29
29	-	-	CONTROL	-
30	AD [14]	D14	BIDIR	31
31	-	-	CONTROL	-
32	AD [15]	C12	BIDIR	33
33	-	-	CONTROL	-
34	CBE [1]	C14	BIDIR	35
35	-	-	CONTROL	-
36	PAR	B13	BIDIR	37
37	-	-	CONTROL	-
38	SERR_L	B14	BIDIR	39
39	-	-	CONTROL	-
40	PERR_L	A14	BIDIR	41
41	-	-	CONTROL	-
42	LOCK_L	A13	BIDIR	43

Boundary Scan Register Number	Pin Name	Ball Location	Type	Tri-state Control Cell
43	-	-	CONTROL	-
44	STOP_L	A12	BIDIR	45
45	-	-	CONTROL	-
46	DEVSEL_L	B11	BIDIR	47
47	-	-	CONTROL	-
48	TRDY_L	A11	BIDIR	47
49	IRDY_L	D10	BIDIR	50
50	-	-	CONTROL	-
51	FRAME_L	B10	BIDIR	52
52	-	-	CONTROL	-
53	CBE [2]	A10	BIDIR	54
54	-	-	CONTROL	-
55	AD [16]	C9	BIDIR	56
56	-	-	CONTROL	-
57	AD [17]	B9	BIDIR	58
58	-	-	CONTROL	-
59	AD [18]	D8	BIDIR	60
60	-	-	CONTROL	-
61	AD [19]	C8	BIDIR	62
62	-	-	CONTROL	-
63	AD [20]	A8	BIDIR	64
64	-	-	CONTROL	-
65	AD [21]	D7	BIDIR	66
66	-	-	CONTROL	-
67	AD [22]	B7	BIDIR	68
68	-	-	CONTROL	-
69	AD [23]	A7	BIDIR	70
70	-	-	CONTROL	-
71	CBE [3]	C6	BIDIR	72
72	-	-	CONTROL	-
73	AD [24]	B6	BIDIR	74
74	-	-	CONTROL	-
75	AD [25]	D5	BIDIR	76
76	-	-	CONTROL	-
77	AD [26]	C5	BIDIR	78
78	-	-	CONTROL	-
79	AD [27]	A5	BIDIR	80
80	-	-	CONTROL	-
81	AD [28]	D4	BIDIR	82
82	-	-	CONTROL	-
83	AD [29]	B4	BIDIR	84
84	-	-	CONTROL	-
85	AD [30]	A4	BIDIR	86
86	-	-	CONTROL	-
87	AD [31]	B3	BIDIR	88
88	-	-	CONTROL	-
89	PME_L	A3	BIDIR	90
90	-	-	CONTROL	-
91	SMBCLK	A2	BIDIR	92
92	-	-	CONTROL	-
93	SMBDAT	A1	BIDIR	94
94	-	-	CONTROL	-
95	CLKRUN_L	D3	BIDIR	96
96	-	-	CONTROL	-
97	FBCLKIN	C2	INPUT	-
98	RESERVED 0	B1	INPUT	-
99	RESERVED 1	D2	OUTPUT3	100
100	-	-	CONTROL	-
101	PERST_L	L3	BIDIR	102
102	-	-	CONTROL	-
103	REQ_L [0]	M1	INPUT	-
104	REQ_L [1]	M2	INPUT	-

Boundary Scan Register Number	Pin Name	Ball Location	Type	Tri-state Control Cell
105	REQ_L [2]	M3	INPUT	-
106	REQ_L [3]	N1	INPUT	-
107	REQ_L [4]	N2	INPUT	-
108	REQ_L [5]	N3	INPUT	-
109	REQ_L [6]	P1	INPUT	-
110	REQ_L [7]	P2	INPUT	-
111	INTA_L	P3	BIDIR	112
112	-	-	CONTROL	-
113	GNT_L [0]	M4	OUTPUT3	114
114	-	-	CONTROL	-
115	GNT_L [1]	N4	OUTPUT3	122
116	GNT_L [2]	L5	OUTPUT3	122
117	GNT_L [3]	M5	OUTPUT3	122
118	GNT_L [4]	N5	OUTPUT3	122
119	GNT_L [5]	P5	OUTPUT3	122
120	GNT_L [6]	P6	OUTPUT3	122
121	GNT_L [7]	N6	OUTPUT3	122
122	-	-	CONTROL	-
123	INTB_L	M6	BIDIR	124
124	-	-	CONTROL	-
125	CLKIN	P7	INPUT	-
126	RESET_L	N7	BIDIR	126
127	-	-	CONTROL	-
128	CFN_L	M7	INPUT	-
129	GPIO [3]	L7	BIDIR	129
130	-	-	CONTROL	-
131	GPIO [2]	P8	BIDIR	131
132	-	-	CONTROL	-
133	GPIO [1]	M8	BIDIR	133
134	-	-	CONTROL	-
135	GPIO [0]	L8	BIDIR	135
136	-	-	CONTROL	-
137	CLKOUT [0]	P9	OUTPUT3	145
138	CLKOUT [1]	N9	OUTPUT3	145
139	CLKOUT [2]	L9	OUTPUT3	145
140	CLKOUT [3]	P10	OUTPUT3	145
141	CLKOUT [4]	M10	OUTPUT3	145
142	CLKOUT [5]	L10	OUTPUT3	145
143	CLKOUT [6]	N11	OUTPUT3	145
144	CLKOUT [7]	P12	OUTPUT3	145
145	CLKOUT [8]	N12	OUTPUT3	145
146	-	-	CONTROL	-
147	INTC_L	P13	BIDIR	148
148	-	-	CONTROL	-
149	REVRSB	M12	INPUT	-
150	INTD_L	N13	BIDIR	151
151	-	-	CONTROL	-
152	MSK_IN	P14	INPUT	-
153	IDSEL	N14	INPUT	-

15 POWER MANAGEMENT

PI7C9X110 supports D0, D3-hot, D3-cold Power States. D1 and D2 states are not supported. The PCI Express Physical Link Layer of the PI7C9X110 device supports the PCI Express Link Power Management with L0, L0s, L1, L2/L3 ready and L3 Power States. For the PCI Port of PI7C9X110, it supports the standard PCI Power Management States with B0, B1, B2 and B3.

During D3-hot state, the main power supplies of VDDP, VDDC, and VD33 can be turned off to save power while keeping the VDDAUX, VDDCAUX, and VAUX with the auxiliary power supplies to maintain all necessary information to be restored to the full power D0 state. PI7C9X110 has been designed to have sticky registers that are powered by auxiliary power supplies. PME_L pin allows PCI devices to request power management state changes. Along with the operating system and application software, PCI devices can achieve optimum power saving by using PME_L in forward bridge mode. PI7C9X110 converts PME_L signal information to power management messages to the upstream switches or root complex. In reverse bridge mode, PI7C9X110 converts the power management event messages from PCIe devices to the PME_L signal and continues to request power management state change to the host bridge.

PI7C9X110 also supports ASPM (Active State Power Management) to facilitate the link power saving.

PI7C9X110 supports Beacon generation but does not support WAKE# signal.

16 POWER SEQUENCING

The PI7C9X110SL require two voltages: 3.3V I/O voltage and 1.8V core voltage. The 1.8V VDDCAUX is consider the same as core voltage, and can be combined as one. When designing the power supplies for PI7C9X110SL, the user can either apply ALL voltages at the same time, or turn on the higher voltage (3.3V) first, followed by the lower voltages (1.8V) within suggested limits. If all power rails are not applied at the same time, the PI7C9X110SL will not be damaged as long as 3.3V is applied either before or at the same time as 1.8V.

During power cycle, if there is a delay in applying 1.8V core voltage after the 3.3V is applied, the internal logic might be placed in an unknown state if the power off period is not long enough to cause the device totally discharged. This condition in turn may produce undetermined I/O states on some pins. If the core logic is totally discharged before applying 3.3V, then all bi-directional I/O pins will stay at their default states.

The typical time for PI7C9X110SL to discharge completely is less than 3 seconds, but in extreme cases this period can be as long as 50 seconds. Certain precautions should be made if the delay between 3.3V and 1.8V is larger than 50ms. Figure 16-1 below shows the I/O timing sequence with undetermined I/O state, and Figure 16-2 shows the recommended power sequence timing.

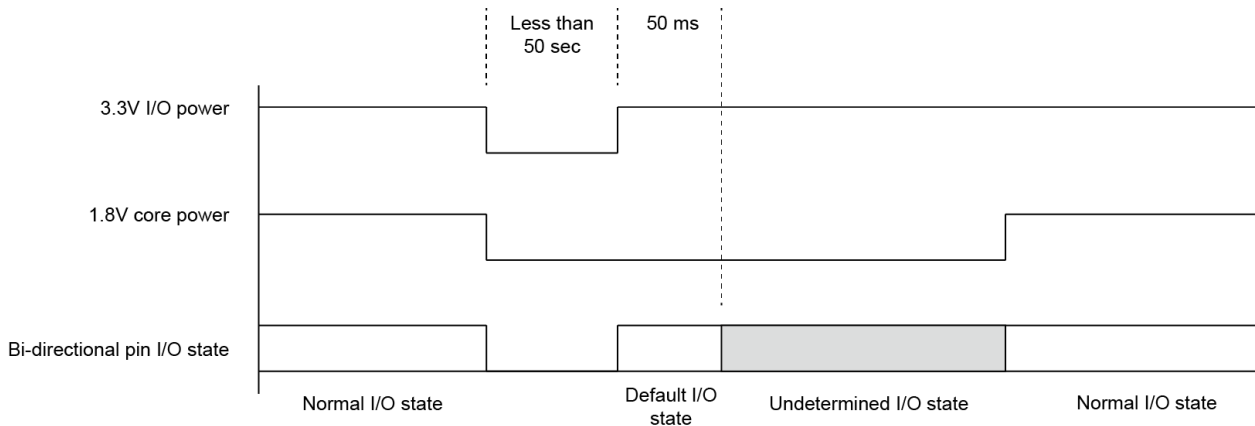

Figure 16-1 Timing sequence with undetermined I/O state

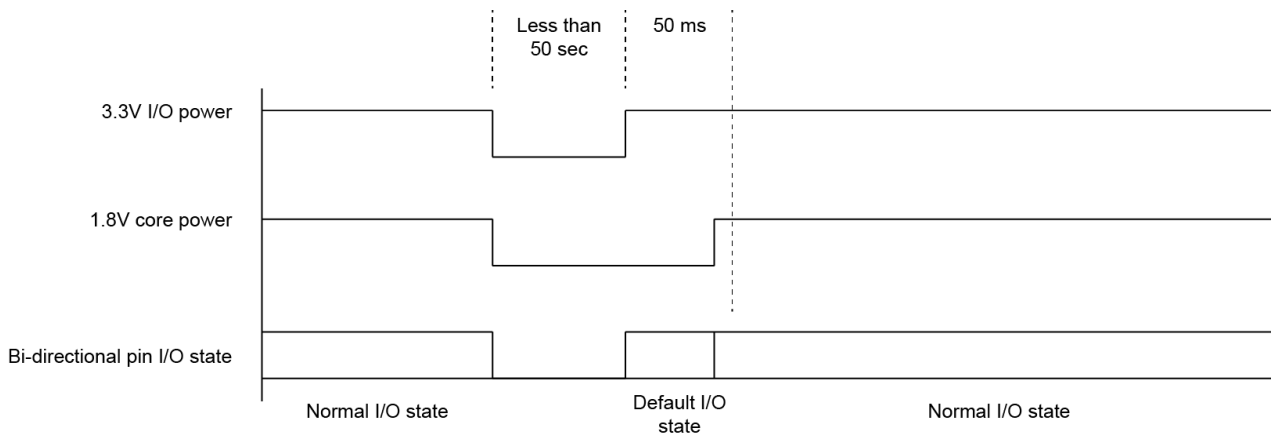

Figure 16-2 Recommended Power Sequence

16.1 INITIAL POWER-UP (G3 TO L0)

As long as PERST# is active, all PCI Express functions are held in reset. The main supplies ramp up to their specified levels (3.3V and 12V). Sometime during this stabilization time, the REFCLK starts and stabilizes. After there has been time (T_{PVPERL}) for the power and clock to become stable, PERST# is deasserted high and the PCI Express functions can start up.

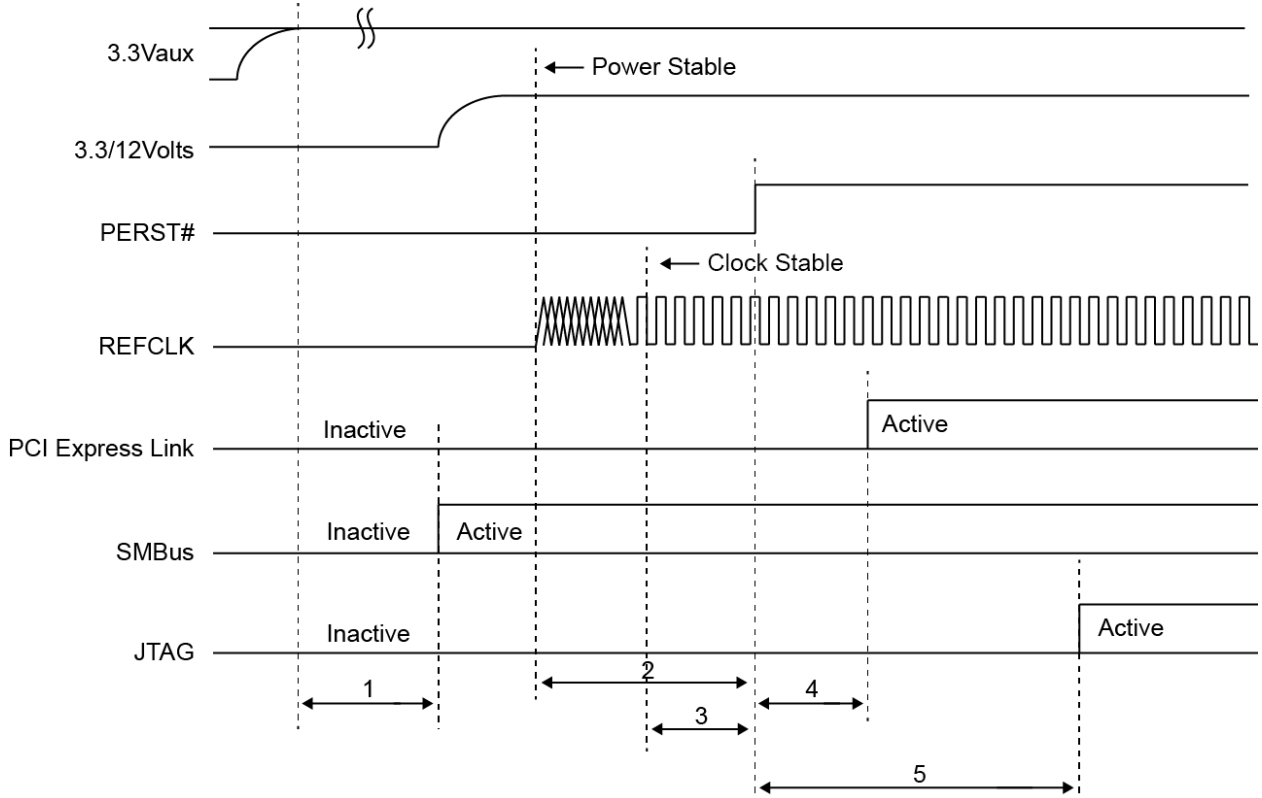

Figure 16-3 Initial Power-up

1. 3.3Vaux stable to SMBus driven (optional). If no 3.3Vaux on platform, the delay is from +3.3V stable
2. Minimum time from power rails within specified tolerance to PERST# inactive (T_{PVPERL})
3. Minimum clock valid to PERST# inactive ($T_{PERST-CLK}$)
4. Minimum PERST# inactive to PCI Express link out of electrical idle
5. Minimum PERST# inactive to JTAG driven (optional)

Table 16-1 Power Sequencing and Reset Signal Timings

Symbol	Parameter	Min	Max	Units
T_{PVPERL}^1	Power stable to PERST# inactive	100		ms
$T_{PERST-CLK}^2$	REF CLK stable before PERST# inactive	100		μ s
T_{PERST}	PERST# active time	100		μ s
T_{FAIL}^3	Power level invalid to PERST# active		500	ns
T_{WKRF}^4	WAKE# rise – fall time		100	ns

Note:

1. Any supplied power is stable when it meets the requirements specified for that power supply.
2. A supplied reference clock is stable when it meets the requirements specified for the reference clock. The PEREST# signal is asserted and de-asserted asynchronously with respect to the supplied reference clock.
3. The PEREST# signal must be asserted within T_{FAIL} of any supplied power going out specification.
4. Measured from WAKE# assertion/de-assertion to valid input level at the system PM controller. Since WAKE# is an open-drain signal, the rise time is dependent on the total capacitance on the platform and the system board pull-up resistor. It is the responsibility of the system designer to meet the rise time specification.

17 ELECTRICAL AND TIMING SPECIFICATIONS

17.1 ABSOLUTE MAXIMUM RATINGS

Table 17-1 Absolute maximum ratings

(Above which the useful life may be impaired. For user guidelines, not tested.)

Storage Temperature	-65°C to 150°C
Maximum Junction Temperature (T _j)	125°C
PCI Express supply voltage to ground potential (VDDA, VDDP, VDDC, VDDAUX, and VDDCAUX)	-0.3v to 2.1v
PCI Express Termination Supply Voltage to ground potential (VTT)	-0.3v to 2.1v
PCI supply voltage to ground potential (VD33 and VAUX)	-0.3v to 3.8v
DC input voltage for PCI Express signals	-0.3v to 2.1v
DC input voltage for PCI signals	-0.3v to 5.75v

Note:

Stresses greater than those listed under MAXIMUM RATINGS may cause permanent damage to the device. This is a stress rating only and functional operation of the device at these or any conditions above those indicated in the operational sections of this specification is not implied. Exposure to absolute maximum rating conditions for extended periods of time may affect reliability.

17.2 DC SPECIFICATIONS

Table 17-2 DC electrical characteristics

Symbol	Description	Condition	Min.	Typ.	Max.	Unit
VDDA	Analog Power Supply for PCI Express Interface		1.6	1.8	2.0	V
VDDP	Digital Power Supply for PCI Express Interface		1.6	1.8	2.0	V
VDDC	Digital Power Supply for the Core		1.6	1.8	2.0	V
VDDAUX	Digital Auxiliary Power Supply for PCI Express Interface		1.6	1.8	2.0	V
VDDCAUX	Digital Auxiliary Power Supply for the Core		1.6	1.8	2.0	V
VTT	Termination Power Supply for PCI Express Interface		1.6	1.8	2.0	V
VD33	Digital Power Supply for PCI Interface		3.0	3.3	3.6	V
VAUX	Digital Auxiliary Power Supply for PCI Interface		3.0	3.3	3.6	V
V _{IH}	PCI Input High Voltage		1.55		5.5	V
V _{IL}	PCI Input Low Voltage		-0.3		1.08	V
I _{IL}	PCI Input Leakage Current	0 < V _{IN} < VD33			±10	μA
V _{OH}	PCI Output High Voltage	I _{out} = -500μA	2.7			V
V _{OL}	PCI Output Low Voltage	I _{out} = 1500μA			0.36	V
C _{IN}	PCI Input Pin Capacitance				10	pF
C _{CLK}	PCI CLK Pin Capacitance		5		12	pF
C _{IDSEL}	PCI IDSEL Pin Capacitance				8	pF

In order to support auxiliary power management fully, it is recommended to have VDDP and VDDAUX separated. By the same token, VD33/VDDC and VAUX/VDDCAUX need to be separated for auxiliary power management support. However, if auxiliary power management is not required, VD33 and VDDC can be connected to VAUX and VDDCAUX respectively.

The typical power consumption of PI7C9X110 is about 1.0 watt.

PI7C9X110 is capable of sustaining 2000V human body model for the ESD protection without any damages.

17.3 AC SPECIFICATIONS

Table 17-3 PCI Bus Timing Parameters

Symbol	Parameter	66 MHz		33 MHz		Units
		MIN	MAX	MIN	MAX	
T _{su}	Input setup time to CLK – based signals ^{1,2,3}	3	-	7	-	ns
T _{su} (ptp)	Input setup time to CLK – point-to-point ^{1,2,3}	5	-	10, 12 ⁴	-	
T _h	Input signal hold time from CLK ^{1,2}	0	-	0	-	
T _{val}	CLK to signal valid delay – based signals ^{1,2,3}	2	6	2	11	
T _{val} (ptp)	CLK to signal valid delay – point-to-point ^{1,2,3}	2	6	2	12	
T _{on}	Float to active delay ^{1,2}	2	-	2	-	
T _{off}	Active to float delay ^{1,2}	-	14	-	28	

1. See Figure 17 –1 PCI Signal Timing Measurement Conditions.
2. All PCI interface signals are synchronized to FBCLKIN.
3. Point-to-point signals are REQ_L [7:0], GNT_L [7:0], LOO, and ENUM_L. Bused signals are AD, CBE, PAR, PERR_L, SERR_L, FRAME_L, IRDY_L, TRDY_L, LOCK_L, STOP_L and IDSEL.
4. REQ_L signals have a setup of 10ns and GNT_L signals have a setup of 12ns.

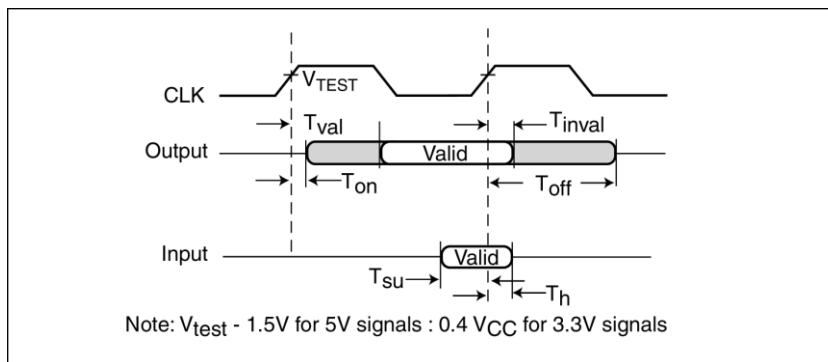

Figure 17-1 PCI signal timing conditions

Table 17-4 specifies the voltage and timing requirements for the input clock signals.

Table 17-4 PCIe Reference Clock Timing Parameters

Symbol	Description	Min.	Typ.	Max.	Units
ClkIn _{FREQ}	Input clock frequency range		100		MHz
ClkIn _{DC}	Duty cycle of input clock	40	50	60	%
T _R , T _F	Rise/Fall time of input clocks			0.2	QCUI*
V _{SW}	Differential input voltage swing (peak-to-peak)	400	600	1200	mV
V _{CM}	Input common voltage	0.6	0.65	0.7	V

*RCUI(Reference Clock Unit Interval) refers to the reference clock period.

Table 17-5 PCI Express Interface - Differential Transmitter (TX) Output Characteristics

Parameter	Symbol	Min	Typ	Max	Unit
Unit Interval	UI	399.88	400.0	400.12	ps
Differential p-p TX voltage swing	V _{TX-DIFF-P-P}	800	-	-	mV ppd
Lower power differential p-p TX voltage swing	V _{TX-DIFF-P-P-LOW}	400	-	-	mV ppd
TX de-emphasis level ratio	V _{TX-DE-RATIO}	-3.0	-	-4.0	dB
Minimum TX eye width	T _{TX-EYE}	0.75	-	-	UI

Parameter	Symbol	Min	Typ	Max	Unit
Maximum time between the jitter median and max deviation from the median	$T_{TX-EYE-MEDIAN-to-MAX-JITTER}$	-	-	0.125	UI
Transmitter rise and fall time	$T_{TX-RISE-FALL}$	0.125	-	-	UI
Maximum TX PLL Bandwidth	BW_{TX-PLL}	-	-	22	MHz
Maximum TX PLL BW for 3dB peaking	$BW_{TX-PLL-LO-3DB}$	1.5	-	-	MHz
Absolute Delta of DC Common Mode Voltage During L0 and Electrical Idle	$V_{TX-CM-DC-ACTIVE-IDLE-DELTA}$	0	-	100	mV
Absolute Delta of DC Common Mode Voltage between D+ and D-	$V_{TX-CM-DC-LINE-DELTA}$	0	-	25	mV
Electrical Idle Differential Peak Output Voltage	$V_{TX-IDLE-DIFF-AC-p}$	0	-	20	mV
The Amount of Voltage Change Allowed During Receiver Detection	$V_{TX-RCV-DETECT}$	-	-	600	mV
Transmitter DC Common Mode Voltage	$V_{TX-DC-CM}$	0	-	3.6	V
Transmitter Short-Circuit Current Limit	$I_{TX-SHORT}$	-	-	90	mA
DC Differential TX Impedance	$Z_{TX-DIFF-DC}$	80	100	120	Ω
Lane-to-Lane Output Skew	$L_{TX-SKEW}$	-	-	500 ps + 2 UI	ps

Table 17-6 PCI Express Interface - Differential Receiver (RX) Input Characteristics

Parameter	Symbol	Min	Typ	Max	Unit
Unit Interval	UI	399.88	400.0	400.12	ps
Differential RX Peak-to-Peak Voltage	$V_{RX-DIFF-PP-CC}$	175	-	1200	mV
Receiver eye time opening	T_{RX-EYE}	0.4	-	-	UI
Maximum time delta between median and deviation from median	$T_{RX-EYE-MEDIAN-to-MAX-JITTER}$	-	-	0.3	UI
Receiver DC common mode impedance	Z_{RX-DC}	40	-	60	Ω
DC differential impedance	$Z_{RX-DIFF-DC}$	80	-	120	Ω
RX AC Common Mode Voltage	$V_{RX-CM-AC-P}$	-	-	150	mV
DC input CM input impedance during reset or power down	$Z_{RX-HIGH-IMP-DC}$	200	-	-	k Ω
Electrical Idle Detect Threshold	$V_{RX-IDLE-DET-DIFF-p}$	65	-	175	mV
Lane to Lane skew	$L_{RX-SKEW}$	-	-	20	ns

17.4 OPERATING AMBIENT TEMPERATURE

Table 17-7 Operating Ambient Temperature

(Above with the useful life may be impaired.)

Item	Low	High	Unit
Ambient Temperature with power applied	-40	85	$^{\circ}\text{C}$

Note: Exposure to high temperature conditions for extended periods of time may affect reliability.

18 PACKAGE INFORMATION

The package of PI7C9X110 is a 12mm x 12mm LFBGA (160 Pin) package. The ball pitch is 0.8mm and the ball size is 0.5mm. The following are the package information and mechanical dimension:

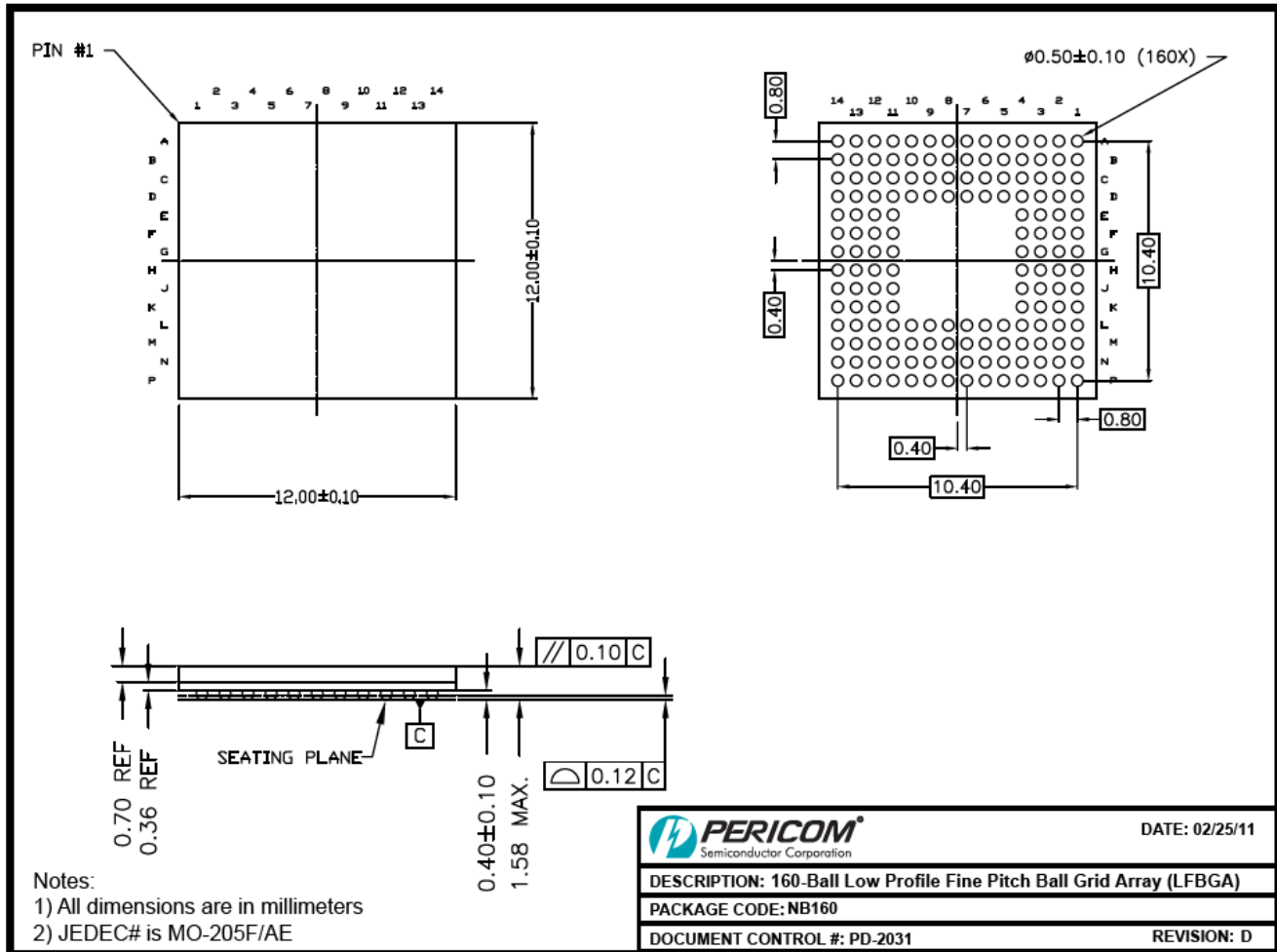

Figure 18-1 Package Outline Drawing



Z: Die Rev
YY: Year
WW: Workweek
1st X: Assembly Code
2nd X: Fab Code

Figure 18-2 Part Marking

19 ORDERING INFORMATION

PART NUMBER	PIN – PACKAGE	TEMPERATURE RANGE
PI7C9X110BNBE	160 – LFBGA	-40°C to 85°C

Notes:

1. No purposely added lead. Fully EU Directive 2002/95/EC (RoHS), 2011/65/EU (RoHS 2) & 2015/863/EU (RoHS 3) compliant.
2. See <https://www.diodes.com/quality/lead-free/> for more information about Diodes Incorporated's definitions of Halogen- and Antimony-free, "Green" and Lead-free.
3. Halogen- and Antimony-free "Green" products are defined as those which contain <900ppm bromine, <900ppm chlorine (<1500ppm total Br + Cl) and <1000ppm antimony compounds.

